

Programmable Controllers  
MELSEC-L series

# Little on size, Large on performance

The new L series has a small footprint and is loaded with features.



MELSEC *L* series

# Simple

## Convenience that fits in the palm of your hand

The L Series is a compact-class controller, part of the MELSEC products renowned for exceptional cost versus performance and strong reliability. It provides the performance, functions, and capabilities required for today's demanding applications in a small package.

MELSEC-L Series greatly expands the range of functionality traditionally associated with compact programmable controllers and through user-centric design, pushes the limits of ease of use.



# MELSEC *L* series

# Flexible

## Ideally configured to satisfy the applications requirements

MELSEC L Series has been designed with three key concepts in mind.

### Reliability

Robust and trusted MELSEC product quality.

### Ease-of-use

Enabling engineers and programmers to do their job as efficiently as possible to reduce costs.

### Flexibility

L Series is a cost-efficient control system flexible to various applications, enabling an ideal system design.

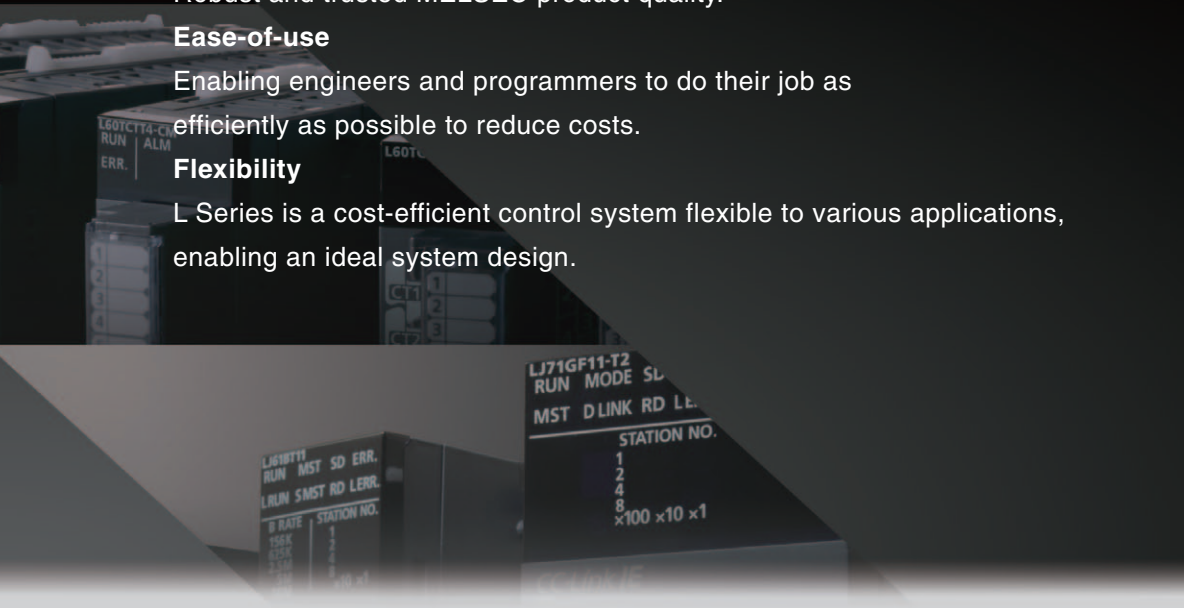

## Maximum Functionality

### The CPU module contains a diverse range of control functions

A large variety of I/O types and features are built-in for convenience. Due to an abundance of advanced functionality, L Series CPUs are flexible enough to meet a wide variety of needs.

## Maximum Performance

### High speed, large memory capacity CPU

The CPU has a basic operation processing speed of 9.5 ns\*4 and 260K steps\*5 of program capacity ideal for complex programs and equipment control.

## Maximum Capabilities

### Advanced capabilities focused on improving efficiency

The user-friendly display unit enables routine operations to be made without a computer. An SD memory card slot\*3 is included as standard for data logging and program storage. Write programs and manage L Series controllers using GX Works2 and iQ Works, the most advanced and effective software for Mitsubishi controllers yet.

\*1: Option (sold separately)  
 \*2: Included with L26CPU-(P)BT  
 \*3: Included with L02CPU-(P), L06CPU-(P), L26CPU-(P), L26CPU-(P)BT  
 \*4: For L06CPU-(P), L26CPU-(P), L26CPU-(P)BT  
 \*5: For L26CPU-(P), L26CPU-(P)BT

L Series Features	P.3
CPU	P.13
I/O	P.21
Analog/Temperature Control	P.25
Simple Motion/Positioning	P.41
High-Speed Counter	P.46
Network	P.47
Digital Link Sensor	P.56
Software	P.59
Related Products	P.69

## L Series Built-in I/O Features

Every L Series CPU comes with 24 points of built-in I/O standard. These I/O points are capable of many functions usually reserved for separate modules. Save on system costs by using the built-in functions rather than relying exclusively on additional modules.

The built-in I/O\*1 comes in sink or source type format and may be chosen based on the application.

### L Series CPU Built-in I/O Functions

Positioning (Built-in control of 2 axes)	High-Speed Counter (Two channels built-in)	Pulse Catch	Interrupt Input	General-purpose Input/Output
Function		Features		
Positioning*2	Number of axes: Maximum 2 axes	Maximum speed: 200K pulses/s High-speed activation: 30 μs (Shortest activation time) S-curve acceleration and deceleration are supported.		
High-Speed Counter*2	Number of channels: Maximum 2 channels	Maximum counting speed: 200K pulses/s Open collector, Differential line driver input High accuracy ON/OFF measurements with a resolution of 5 μs High precision PWM control up to 200 kHz (High speed pulse output)		
Pulse Catch	Number of input points: 16 points	Minimum input response time: 10 μs Pulse signals whose ON time is shorter than the scan time can be detected.		
Interrupt Input	Number of interrupt points: 16 points	Built-in CPU provides high-speed processing. All input points support interrupt inputs.		
General-purpose Input	Number of high-speed inputs: 6 points Number of standard inputs: 10 points	Minimum input response time of high-speed input: 10 μs Minimum input response time of standard input: 100 μs		
General-purpose Output	Number of output points: 8 points	Output response time: 1 μs or less		

\*1: The L02SCPU, L02CPU, L06CPU, L26CPU and L26CPU-BT are sink type, and the L02SCPU-P, L02CPU-P, L06CPU-P, L26CPU-P and L26CPU-PBT are source type.

\*2: Points used by the positioning and high speed counting functions are fixed (as in A phase, B phase, near-point dog). Custom points for these functions may not be assigned.



## Easy setup of built-in I/O functions

Configuring built-in I/O functions can be done easily by setting parameters using the programming tool.

Input Signal Function Selection	Input Response Time	Interrupt Processing Condition
Wn0 Pulse Catch	0.0 ms	Rising
Wn1 Pulse Catch	0.0 ms	Rising
Wn2 Interrupt Input	1 ms	Rising
Wn3 Interrupt Input	1 ms	Falling
Wn4 Interrupt Input	1 ms	Rising
Wn5 Interrupt Input	1 ms	Falling
Wn6 General Input	10 ms	Rising
Wn7 General Input	10 ms	Rising
Wn8 General Input	10 ms	Rising
Wn9 General Input	10 ms	Rising
WnA General Input	10 ms	Rising
WnB General Input	10 ms	Rising
WnC General Input	10 ms	Rising
WnD General Input	10 ms	Rising
WnE General Input	10 ms	Rising
WnF General Input	10 ms	Rising

**Built-in I/O function example parameter settings**  
Pulse Catch: 0.01 ms (response time)  
Interrupt Input: 1 ms (response time)

Positioning Parameter	
Pulse Output Mode	CW/CCW Mode
Rotation Direction Setting	Current Value Increment with Forward Run Pulse Output
S/W Stroke Upper Limit (pulse)	2147483647
S/W Stroke Lower Limit (pulse)	-2147483648
Speed Limit Value (pulse/s)	20000
Base Speed at Start (pulse/s)	0
Acceleration/Deceleration System Selection	Trapezoid Acceleration/Deceleration

**Positioning function example parameter settings**  
Pulse Output Mode: CW/CCW mode  
Rotation Direction Setting:  
Current Value Increment with Forward Run Pulse Output

Operation Mode Setting	Normal Mode
Count Source Selection	A Phase/B Phase
Pulse Input Mode	1-Phase Multiple of 1
Counting Speed Setting	100kpps
Z Phase (Preset) Trigger Setting	Rising
External Preset (Z Phase) Request Detection Setting	ON at detection
Counter Format	Linear Counter
Function Input Logic Setting	Positive Logic
Counter Function Selection	Count Disabling Function
Coincidence Output Time Preset Setting	Not preset
Coincidence Detection Interrupt Setting (Counter Value Coincidence No.1)	Not used
Coincidence Detection Interrupt Setting (Counter Value Coincidence No.2)	Not used
Sampling Time Setting (ms)	
Frequency Movement Averaging Processing Count	
Frequency Measurement Unit Time Setting	
Rotation Speed Movement Averaging Processing Count	
Rotation Speed Measurement Unit Time Setting	
Number of Pulses per Rotation (pulse)	
Pulse Measurement Target Setting	

**High-speed counter function example parameter settings**  
Pulse Input Mode: 1-Phase Multiple of 1  
Counting Speed Setting: 100 kpps

## Built-in CPU positioning control function

### Positioning Function

The built-in positioning function has a start time of just 30 μs with a maximum high speed output of 200K pulses per second.

Furthermore, it supports S-curve acceleration and deceleration for applications that require minimal machine vibration.

### High-Speed Counter Function

Two channels support the high speed counting function. The differential line driver inputs support counting speeds up to 200K pulses per second.

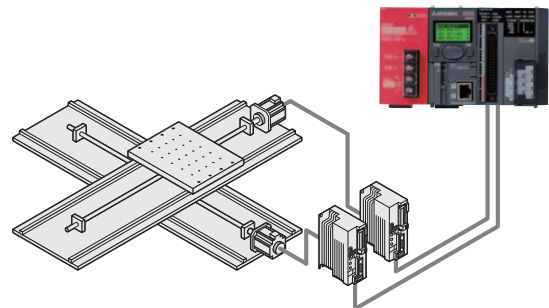

Positioning

High-Speed Counter

### Make highly accurate measurements with a resolution of 5 μs

High-Speed Counter

Using pulse measurement mode, where the input signal ON/OFF time is 200 μs or greater, highly accurate measurements in units of 5 μs or greater are possible.

For example it is possible to calculate length by knowing the "work object passing speed" and measuring the ON time of the sensor.

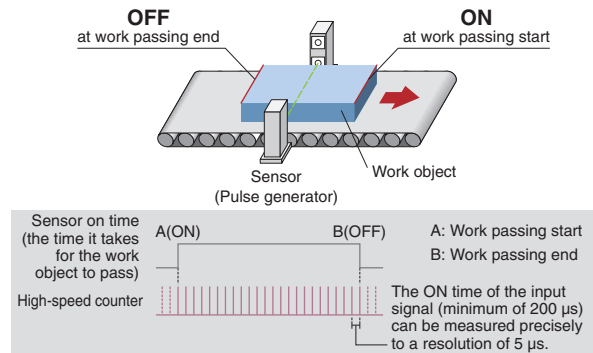

### High precision PWM control up to 200 kHz

High-Speed Counter

Using the pulse width modulation control function of the high speed outputs, cycle times as fast as 5 μs can be created. Simply input the ON time and cycle time to drive a wide range of devices from lighting dimmer control, motors, and heaters to precision inspection equipment requiring high resolution performance.

Setting item	Setting range	Description
PWM output ON time*1	0 or 10... 10000000*1 (0.1 μs)	Set the ON time of output pulse
PWM output cycle time*1	50...10000000*1 (0.1 μs)	Set the cycle time of output pulse

\*1: The PWM output ON time must be ≤ than PWM output cycle time.

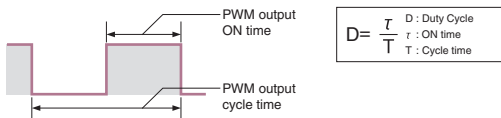

#### Lighting dimmer control using PWM output

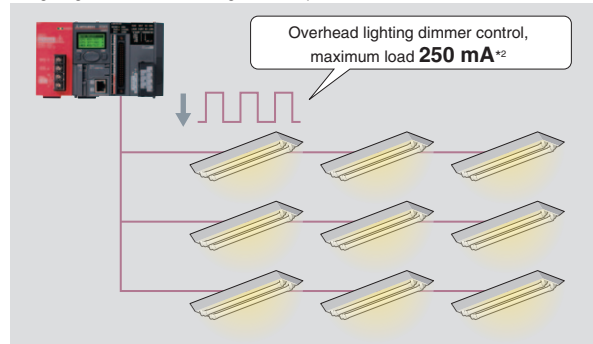

\*2: In cases where the first six digits of the serial number are "120722" or later. Previous serial numbers of the CPU module are applied to 100 mA.

### Guaranteed input pulse detection

Pulse Catch

Typical programmable controller input devices are unable to detect pulse signals whose ON time is shorter than the scan time or do not occur during I/O refresh periods. The pulse catch function allows these signals to be reliably detected and passed to the sequence program. This function is different from the interrupt input function in that it does not require any special programming. Pulse catch inputs may be used in programs exactly the same as traditional input (X) signals.

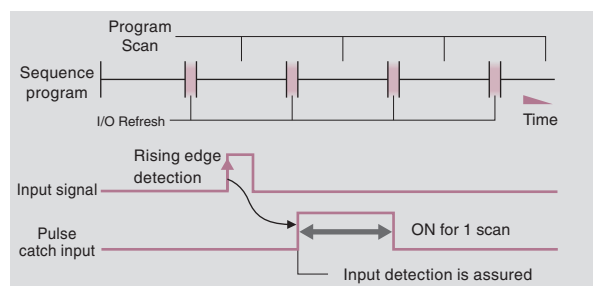

### CPU with built-in CC-Link network connectivity

L26CPU-(P)BT

L Series CC-Link ready CPUs are compatible with the latest generation of CC-Link devices and support connections with over 1,000 different product types. Without adding a module, these CPUs can perform high-speed communication with a maximum of 128 words\*3 between a master station and a local station. CC-Link is the dominate FA network standard in Asia and continues to gain support worldwide.

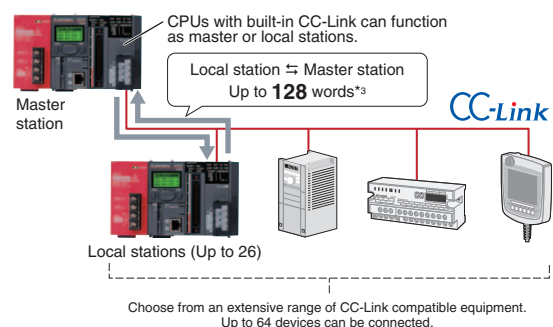

\*3: When the number of occupied stations is 4 and the extended cyclic setting is octuple in the Remote net Ver.2 mode.

## L Series Features

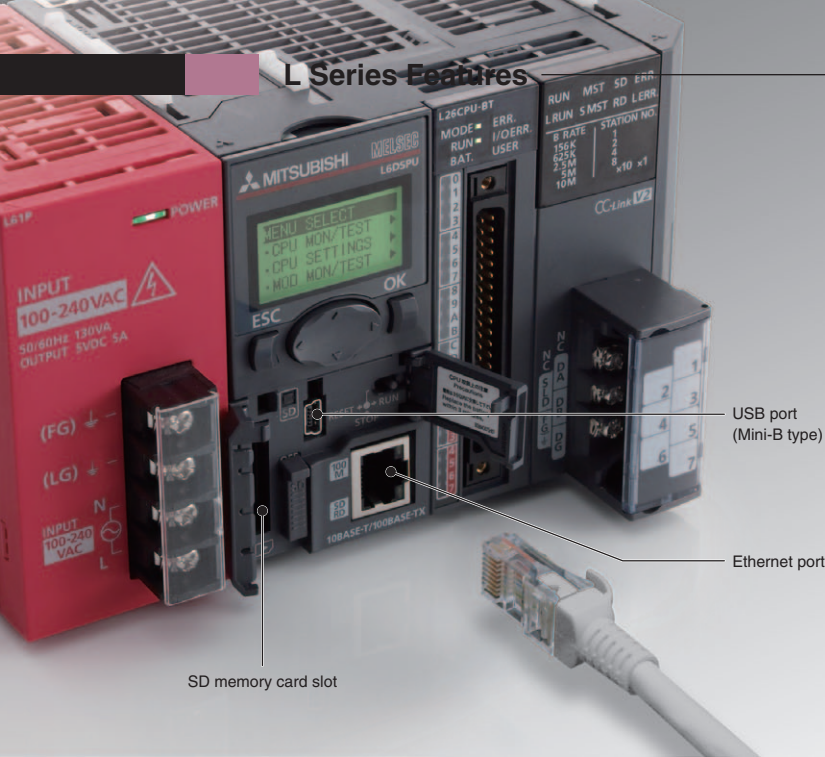

## Convenient communication and storage options come as standard

Program, configure, and perform diagnostics on L Series systems using either the USB 2.0 or Ethernet connections. The SD Memory Card has many uses including the easy backup and restore of programs and parameters.



L02CPU(-) L06CPU(-) L26CPU(-) L26CPU(-)BT

## USB and Ethernet connections standard

Use the USB 2.0 interface or Ethernet to connect directly at the installation site. The Ethernet interface supports direct connection with either a cross or straight LAN cable and does not require any configuration of the programmable controller or PC to operate.

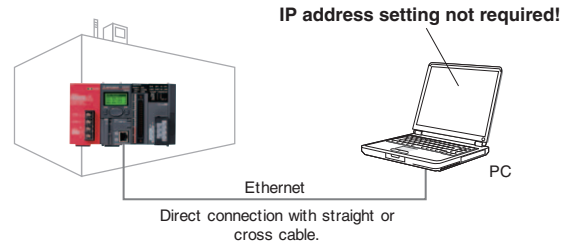

## Easy connection through hub

All CPUs connected to the same hub can be searched and displayed in a list. By selecting the access target CPU from the list, it can be connected to even if the IP address is unknown.

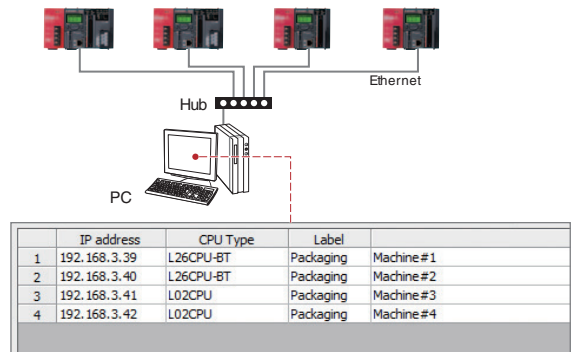

Use GX Works2 to retrieve a list of all CPUs connected to the network.

## Easily connect to BACnet™ and MODBUS®/TCP Improved function

Ethernet realizes a high-speed connection, such as communication with external devices.

By using the predefined protocol support function, various devices that require open network protocol support, such as BACnet™ and MODBUS®/TCP are supported.

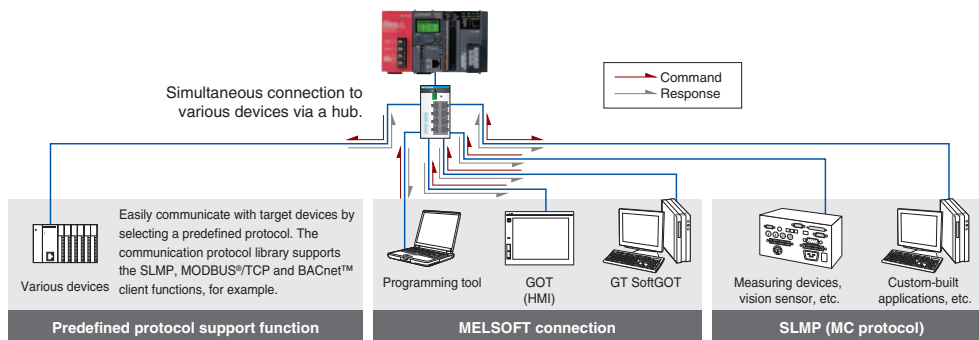

## Network timestamp

Synchronize systems on an Ethernet network using an SNTP\*1 server. Time synchronization can be achieved to enable simultaneous operations, quality control, or error tracking.

\*1: SNTP: Simple Network Time Protocol

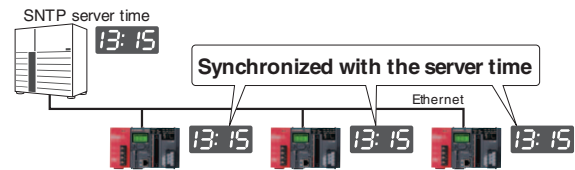

## Program-less device data transfer

### Simple PLC communication function\*2

Using the programming tool, a simple parameter setting is all that is needed to transfer device data such as production information with no programming required.

This function makes it possible to easily establish communications not only with L Series, but also Q Series and Qn/A Series controllers.

\*2: CPU module whose first five serial number digits are "13042" or later is required.

Simple PLC Communication Setting

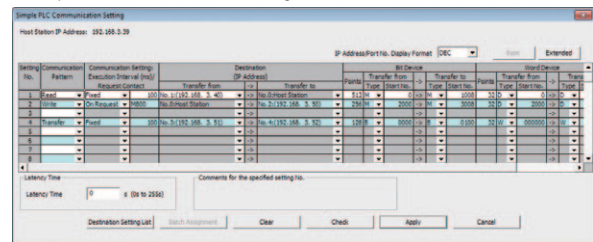

Item	Description	
Communication pattern	Read	Read the data of the specified destination device (transmission source) to the specified device of the host station (transmission destination).
	Write	Write the data of the specified device of the host station (transmission source) to the specified destination device (transmission destination).
	Transfer	Read the data of the specified destination device (transmission source) and write it to another specified destination device (transmission destination).
Communication setting	Execution interval	Set between 10 ms and 65535 ms (1 ms unit)
	Request contact	Data send/receive is executed at the rising edge (OFF to ON) of the specified device (X, M, B).
Available devices	Setting No.	Set between 1 and 64.
	Device points	The maximum number that can be set for each setting No. is 512 words. (Maximum points of a word device: 256 points + Maximum points of a bit device: 4096 points) The total of setting No. 1...64 is maximum 4096 words.

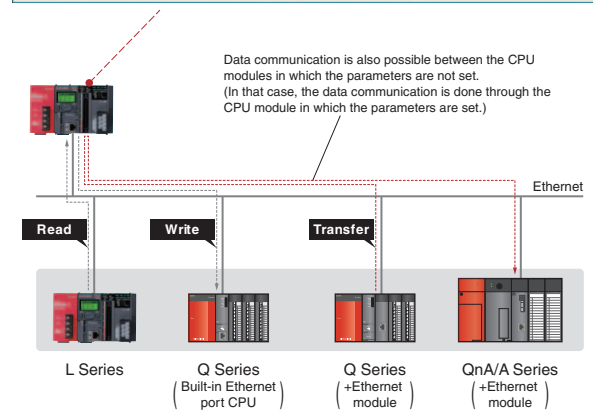

## SD memory card special features

Use the SD/SDHC compatible memory card to quickly and easily back-up the CPU programs and parameters.

The backups can then be just as easily restored or used to program other CPUs. The memory card can also be used to hold data captured with the data logging function\*3.

\*3: For details about the data logging function, please refer to page 9.

## Save/load programs directly into the Programmable Controller

### Multiple project save/load function\*4

Parameters, program files, etc., can be saved/read onto an SD memory card by simply using the onboard display unit, without having to connect to a separate PC. Once saved on the SD memory card, files can be sent via e-mail, for example, when requiring off-site editing of the files.

\*4: Supported by CPU module whose first five serial number digits are "14042" or later.





## Gain more flexibility with an integrated system bus structure

Save space in control panels by utilizing the integrated system bus structure. Flexibility in system design is made possible by choosing only the required expansion modules for the application.

### Expand L Series systems with no base unit restrictions

L Series modules do not require a base unit. The installation space is not restricted by base size, and the system can be installed with minimal required space.

Furthermore, the addition of modules to the system is not restricted by the number of available base unit slots and costs may be reduced due to the elimination of extension base units.

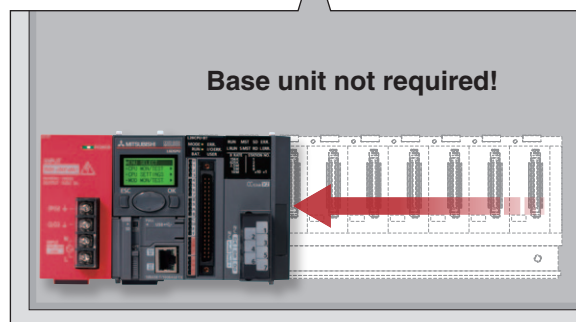
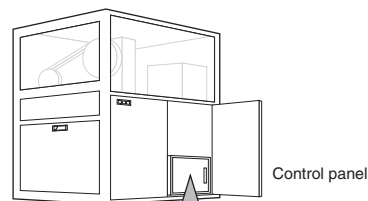

Installation space is reduced in the control panel

### Identify important information easily

Every L Series module has the serial number printed on the front surface of the module to allow viewing even during system operation (modules do not need to be removed).

\*: Serial numbers can also be checked using GX Works2.

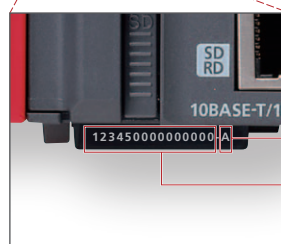

Function version  
A serial number is printed on the front surface.



## System expandable according to production equipment scale

Up to three extension blocks connectable to the main block using branch and extension modules. A maximum of 40 modules\*1 caters a wide range of production equipment and line scale.

CPU module*2	Number of extension blocks	Number of connectable modules*3
L02SCPU(-P) L02CPU(-P)	Up to 2 blocks	Main block: 10 modules Extension block: 11 modules
L06CPU(-P) L26CPU(-P)	Up to 3 blocks	
L26CPU(-P)BT		

\*1: In the case of L06CPU(-P), L26CPU(-P), and L26CPU(-P)BT.

\*2: CPU modules whose first five serial number digits are 13072 or later.

\*3: Total number of I/O modules, intelligent function modules, network modules and branch modules.

This does not include the following: Power supply, CPU, display units, extension modules, RS-232 adapter, RS-422/485 adapter, and END covers.

When adding a branch module to a fully occupied block, relocate one of the other modules to a new block to give way to the branch module.

### Example of largest system configuration of L26CPU-BT

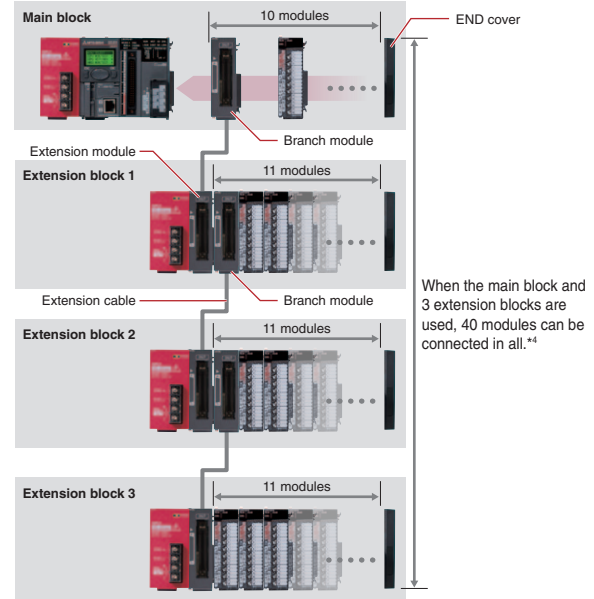

\*4: Total number of I/O modules, intelligent function modules and network modules, excluding branch modules.

## Well-organized control panel with minimum wiring

Branch module can be strategically placed in a block to minimize wiring space. Extension cables are available in 0.6-, 1.0- and 3.0-m. The maximum extension length is 3.0 m\*5.

The extension cable is a one-touch type which can be easily connected and disconnected.

\*5: The total length of extension cables should be within 3.0 m.

### Example of vertical system configuration

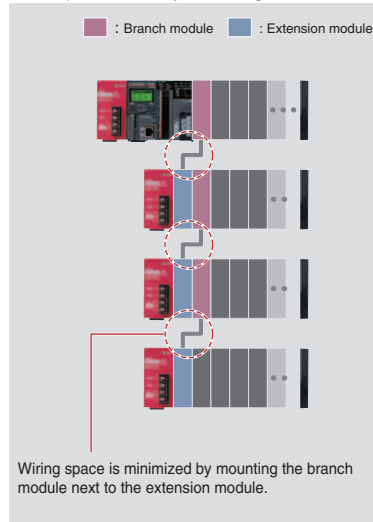

### Example of horizontal system configuration

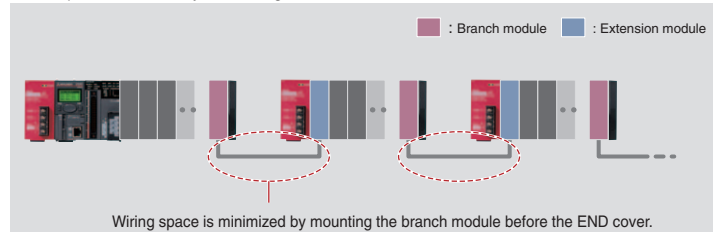

### Example of vertical and horizontal mixed system

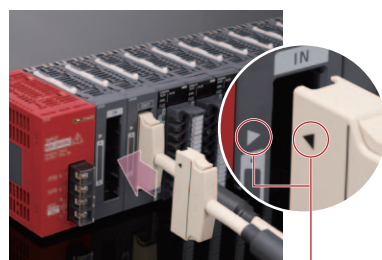
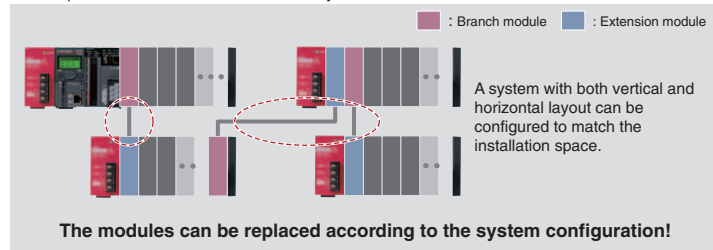

Matching marks on the slot and the cable

### Installation position when branch or extension module is used

Modules	Installed block	Possible installation position
Branch module	Main block	Right side of CPU module or left side of END cover
	Extension block	Right side of extension module or left side of END cover
Extension module	Main block	Not applicable
	Extension block	Right side of power supply module

## Data logging function\*1

The data logging function embedded in the CPU module allows collected data to be saved in CSV format on an SD memory card simply by using the dedicated setting tool wizard. Various reference materials including daily reports, form creation and general reports can be created easily within the saved CSV file. This data can be used for a wide variety of applications requiring traceability, production data, etc.

\*1: Not equipped in L02SCPU(-P).

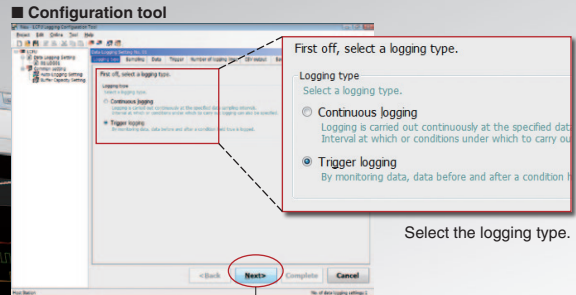
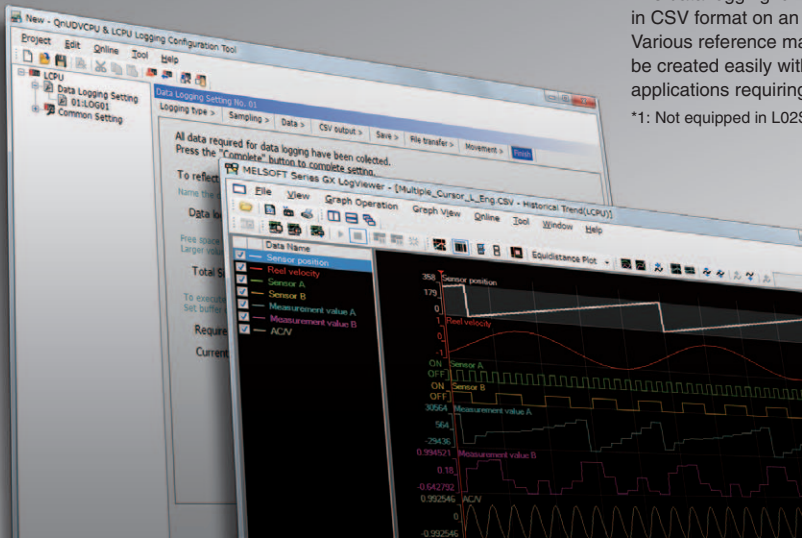

Make the desired settings on each screen and click the [Next] button until all settings are complete.

L02CPU(-P) L06CPU(-P) L26CPU(-P) L26CPU(-P)BT

## Easy logging without a program

Logging of device data just by configuring the parameters. The results can be saved in CSV format on an SD memory card.

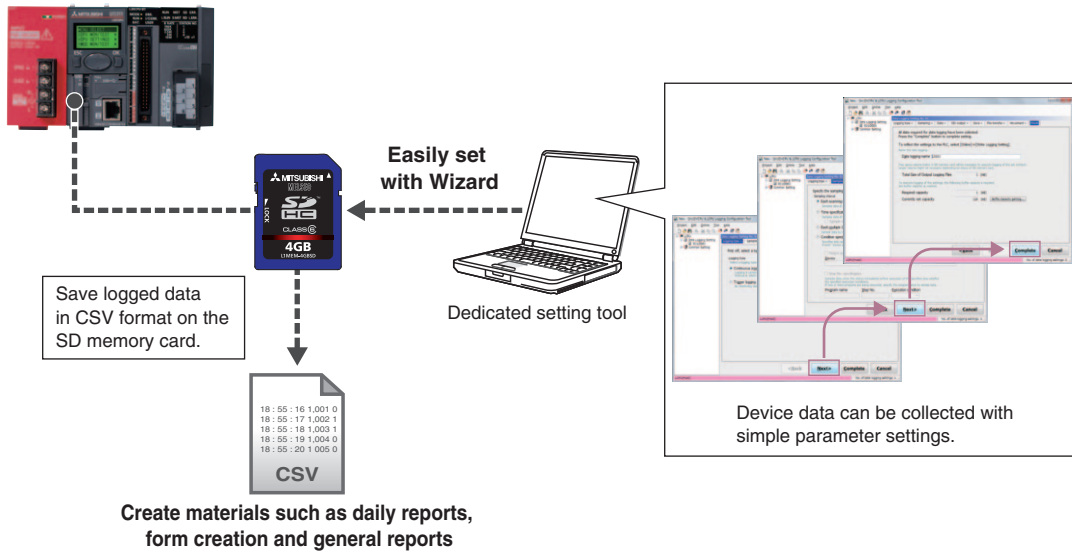

## Logging of control data variances

Data is collected during each scan or within millisecond intervals allowing detection of control deviation even at very high speeds. Therefore, identification of errors can be conducted faster and in more detail.

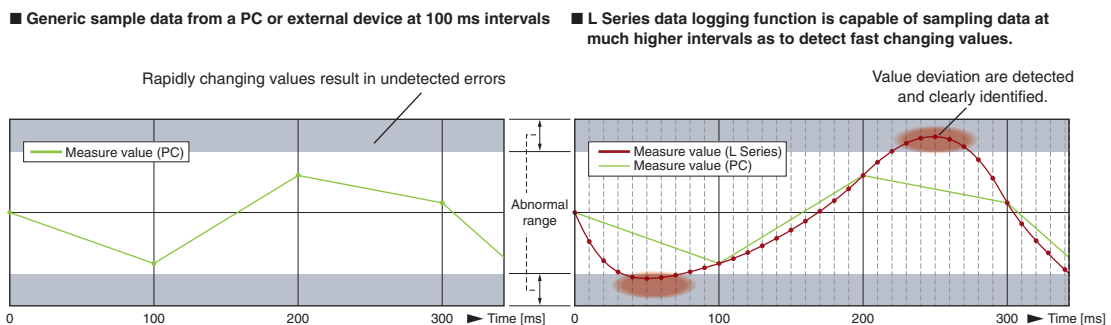

## Auto logging function

Automatic data logging realized just by inserting the SD memory card into the CPU, which is achieved as the memory card includes the logging configuration file. Instructing data logging remotely is also realized just by sending the configuration file by e-mail and copying onto the SD memory card.

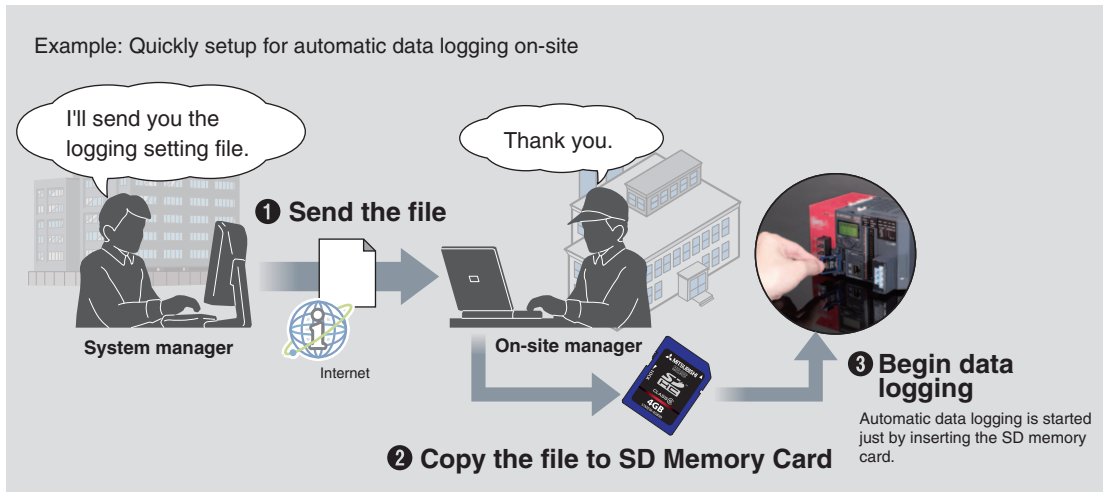

## Automatically send logging files to FTP server

Data logging files saved on the SD memory card can be sent to the FTP server just by making a simple setting with the logging configuration tool. As the logging server can handle multiple files, management and maintenance tasks can be reduced.

### File transfer feature\*1

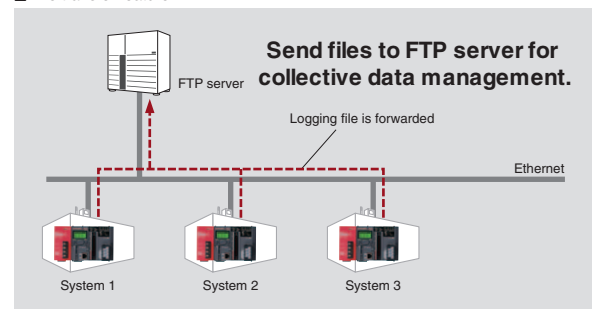

\*1: Using a CPU module with the first 5 digits of the serial number "12112" or later.

## Trigger logging function

Error causes and solutions can be quickly done as only the required data related to the problem is extracted, without having to spend time on filtering large volumes of diagnostic data.

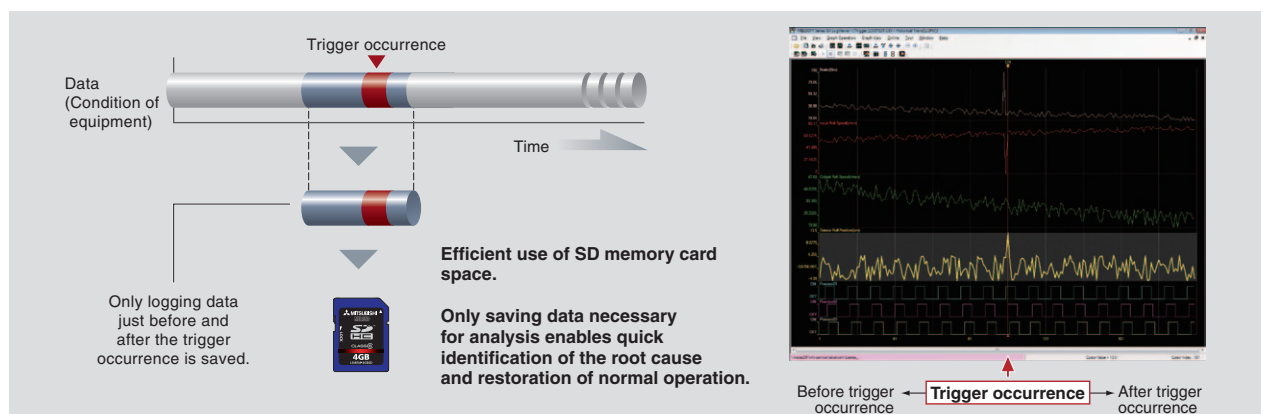

To receive a copy of GX LogViewer, contact your local Mitsubishi Electric representative.

## L Series Features

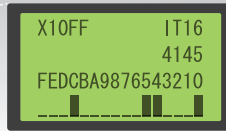

Device monitor

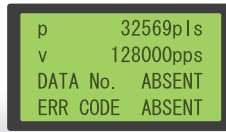

Built-in I/O monitor

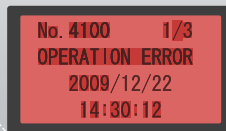

Error message display  
(Red backlight)

## Feature rich and easy to use display

Check the system status and make setting changes directly from the display. Error status is clearly identified and troubleshooting and error investigation can be performed all without the need for any connections or engineering software.

\*: Not available for L02SCPU(-P).

L02CPU(-P) L06CPU(-P) L26CPU(-P) L26CPU(-P)BT

### Instant error information check

Error history and detailed error information are available directly from the display unit.

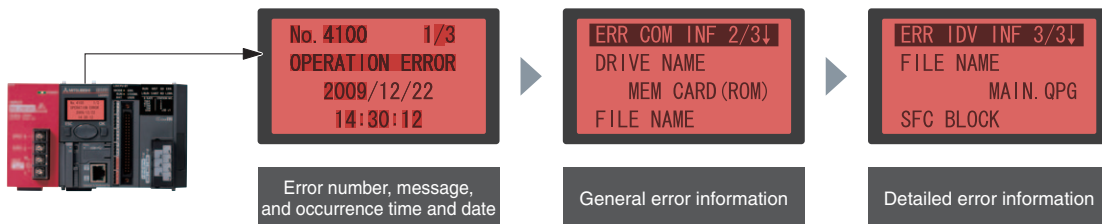

### Intuitive menu navigation

The menu navigation guide shows the current menu tree location and an arrow to indicate the scroll direction at the top of the display.

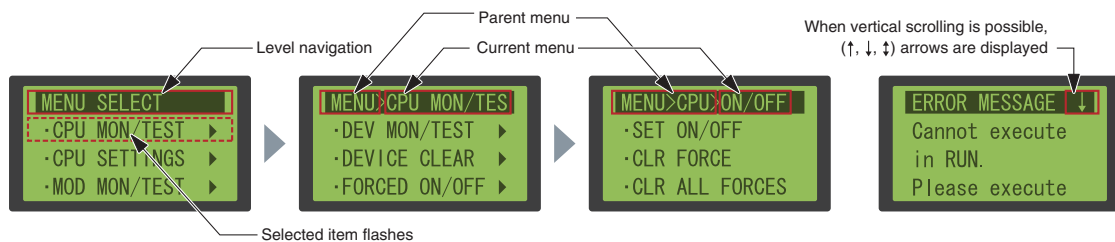

### Multilingual operation

The display unit language can be selected (Japanese or English).





Universal Design

## An easy-to-use modular design

The L Series module labeling design has been created to ensure clear legibility and identification of information at a glance to avoid mistakes.

L Series Features

CPU

I/O

### Universal design

#### Adopting a universal font

A high visibility font has been chosen for characters printed on system modules.

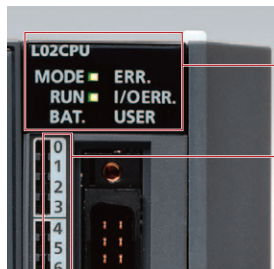

#### Regular Gothic font



The characters are thick enough, however the numbers "3, 6, 8, 9" and the alphabet "C" are not clearly distinguishable because the spacing indicated with a red circle is not large enough.

#### Font for L Series

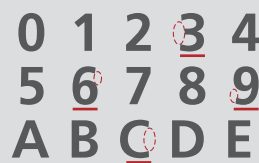

The space indicated with a red circle has been enlarged. The numbers "3, 6, 8, 9" and the alphabet "C" are clearly distinguishable. Characters are legible even in small print.

#### Module design

White and red are used to distinguish inputs from outputs respectively to allow for easy identification of terminal connection type.

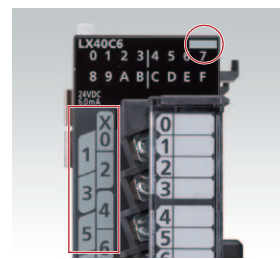

White for input module

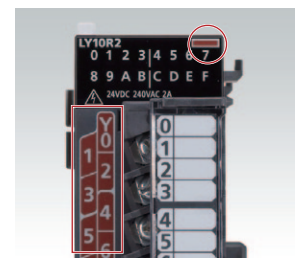

Red for output module

Analog/  
Temperature  
Control

Simple Motion/  
Positioning

High-Speed  
Counter

Network

Digital Link  
Sensor

### Easily identify module status

LEDs display the current status of modules including run and error states.



LEDs are located on the top front surface of the modules.

Software

Related Products

CPU Modules

<b>Communication interface:</b> RS-232		<b>L02SCPU</b> General-purpose output: Sink type Program capacity: 20K steps Basic operation processing speed: 60 ns *: End cover is enclosed. Cannot be mounted on display unit (L6DSPU), RS-232 adapter, RS-422/485 adapter.	<b>L02SCPU-P</b> General-purpose output: Source type Program capacity: 20K steps Basic operation processing speed: 60 ns
	<b>Communication interface:</b> Ethernet		<b>L02CPU</b> General-purpose output: Sink type Program capacity: 20K steps Basic operation processing speed: 40 ns *: END cover is included.
		<b>L06CPU</b> General-purpose output: Sink type Program capacity: 60K steps Basic operation processing speed: 9.5 ns *: END cover is included.	<b>L06CPU-P</b> General-purpose output: Source type Program capacity: 60K steps Basic operation processing speed: 9.5 ns
		<b>L26CPU</b> General-purpose output: Sink type Program capacity: 260K steps Basic operation processing speed: 9.5 ns *: END cover is included.	<b>L26CPU-P</b> General-purpose output: Source type Program capacity: 260K steps Basic operation processing speed: 9.5 ns
		<b>L26CPU-BT</b> General-purpose output: Sink type Program capacity: 260K steps Basic operation processing speed: 9.5 ns *: END cover is included.	<b>L26CPU-PBT</b> General-purpose output: Source type Program capacity: 260K steps Basic operation processing speed: 9.5 ns

Model	General-purpose output	Number of I/O points	Program capacity	Basic operation processing speed (LD instruction)	Peripheral connection ports	Built-in network	
L02SCPU	Sink type	1024 points	20K steps	60 ns	USB/RS-232	—	
L02CPU				40 ns		—	
L06CPU		4096 points	60K steps	9.5 ns		USB/Ethernet	—
L26CPU							260K steps
L26CPU-BT	—		CC-Link				
L02SCPU-P	Source type	1024 points	20K steps	60 ns	USB/RS-232		—
L02CPU-P				40 ns		—	
L06CPU-P		4096 points	60K steps	9.5 ns		USB/Ethernet	—
L26CPU-P							260K steps
L26CPU-PBT			—				CC-Link

CPU packages

- **L02CPU-SET**  
Includes CPU (L02CPU), power supply module (L61P), and display unit (L6DSPU).
- **L02CPU-P-SET**  
Includes CPU (L02CPU-P), power supply module (L61P), and display unit (L6DSPU).



- **L06CPU-SET**  
Includes CPU (L06CPU), power supply module (L61P), and display unit (L6DSPU).
- **L06CPU-P-SET**  
Includes CPU (L06CPU-P), power supply module (L61P), and display unit (L6DSPU).



- **L26CPU-SET**  
Includes CPU (L26CPU), power supply module (L61P), and display unit (L6DSPU).
- **L26CPU-P-SET**  
Includes CPU (L26CPU-P), power supply module (L61P), and display unit (L6DSPU).



- **L26CPU-BT-SET**  
Includes CPU (L26CPU-BT), power supply module (L61P), and display unit (L6DSPU).
- **L26CPU-PBT-SET**  
Includes CPU (L26CPU-PBT), power supply module (L61P), and display unit (L6DSPU).



## ■ General specifications

General specifications indicate the environmental specifications in which this product can be installed and operated. Unless otherwise specified, these general specifications apply to all L Series products.  
 \*: General specifications of jointly developed products are different from those of MELSEC products. For more information, please refer to the product manuals or contact your local Mitsubishi Electric representative.

Item	Specification					
Operating ambient temperature	0...55°C					
Storage ambient temperature	-25...75°C					
Operating ambient humidity	5...95%RH, non-condensing					
Storage ambient humidity	5...95%RH, non-condensing					
Vibration resistance	Compliant with JIS B 3502 and IEC 61131-2	Under intermittent vibration	Frequency	Constant acceleration	Half amplitude	Sweep count 10 times each in X, Y, and Z directions
			5...8.4 Hz	—	3.5 mm	
		Under continuous vibration	8.4...150 Hz	9.8 m/s <sup>2</sup>	—	—
			5...8.4 Hz	—	1.75 mm	
		8.4...150 Hz	4.9 m/s <sup>2</sup>	—		
Shock resistance	Compliant with JIS B 3502 and IEC 61131-2 (147 m/s <sup>2</sup> , 3 times each in X, Y, and Z directions)					
Operating atmosphere	No corrosive gases					
Operating altitude*1	0...2000 m					
Installation location	Inside a control panel					
Overvoltage category*2	≤ II					
Pollution degree*3	≤ 2					
Equipment class	Class I					

\*1: Do not use or store the programmable controller under pressure higher than the atmospheric pressure of altitude 0 m.

Doing so may cause malfunction. When using the programmable controller under pressure, please consult your local Mitsubishi Electric representative.

\*2: This indicates the section of the power supply to which the equipment is assumed to be connected between the public electrical power distribution network and the machinery within premises.

Category II applies to equipment for which electrical power is supplied from fixed facilities. The surge voltage withstand level for up to the rated voltage of 300 V is 2500 V.

\*3: This index indicates the degree to which conductive material is generated in terms of the environment in which the equipment is used.

Pollution level 2 is when only non-conductive pollution occurs. A temporary conductivity caused by condensing must be expected occasionally.

## ■ CPU module specifications

Item		L02SCPU L02SCPU-P	L02CPU L02CPU-P	L06CPU L06CPU-P	L26CPU L26CPU-P	L26CPU-BT L26CPU-PBT	
Control method		Stored program cyclic operation					
I/O control mode		Refresh mode (The direct access input/output is available by specifying the direct access input/output (DX, DY).)					
Programming language (sequence control language)		Function block, relay symbol language, MELSAP3 (SFC), MELSAP-L, structured text (ST), logic symbolic language					
Processing speed*4 (sequence instruction)	LD X0	60 ns	40 ns	9.5 ns			
	MOV D0 D1	120 ns	80 ns	19 ns			
Constant scan		0.5...2000 ms (Setting is available in increments of 0.5 ms by parameter.)					
Program size		20K steps (80K bytes)		60K steps (240K bytes)	260K steps (1040K bytes)		
Memory capacity	Program memory (drive 0)	80K bytes		240K bytes	1040K bytes		
	Memory card (RAM) (drive 1)	—					
	Memory card (ROM) (drive 2)	Depends on the SD/SDHC memory card used.*5					
	Standard RAM (drive 3)	128K bytes		768K bytes			
Standard ROM (drive 4)		512K bytes		1024K bytes	2048K bytes		
Maximum number of files stored	Program memory		64 files		124 files	252 files	
	Memory card (RAM)		—				
	Memory card (ROM)	SD	—		Root directory: 511 files (maximum) Subdirectory: 65533 files (maximum)		
		SDHC	—		Root directory: 65534 files (maximum) Subdirectory: 65533 files (maximum)		
	Standard RAM		4 files (each one of the following files: file register file, local device file, sampling trace file, and module error collection file)			256 files	
Standard ROM		128 files		256 files			
Maximum number of intelligent function module parameters	Initial setting	2048 parameters		4096 parameters			
	Refresh	1024 parameters		2048 parameters			
Maximum number of modules specification*6		30		40			
Built-in I/O function		Refer to the built-in I/O specifications ➡ P.16 to P.17					
Data logging function		—		Refer to the data logging function specifications ➡ P.17			
Built-in Ethernet function		—		Refer to the built-in Ethernet specifications ➡ P.18			
Built-in serial communication function		Refer to the built-in serial communication specifications ➡ P.18		—			
Built-in CC-Link function		—				Refer to the CC-Link Master/Local Module specifications. ➡ P.51	
Clock function	Displayed information	Year, month, date, hour, minute, second, and day of the week (automatic leap year detection)					
	Accuracy	0°C: -2.96...+3.74 s (TYP. +1.42 s) per day 25°C: -3.18...+3.74 s (TYP. +1.50 s) per day 55°C: -13.20...+2.12 s (TYP. -3.54 s) per day					
5 V DC internal current consumption	CPU	With display unit	1.00 A		1.06 A	1.43 A	
		Without display unit	0.75 A	0.94 A	1.00 A	1.37 A	
	END cover (Accessory)*7	—		0.04 A		—	
Weight	CPU	With display unit	—		0.40 kg	0.50 kg	
		Without display unit	0.32 kg	—		0.37 kg	0.47 kg
	END cover (Accessory)*7	—		0.06 kg		—	

\*4: Indexing devices does not delay processing time.

\*5: The operation of devices that are not manufactured or recommended as compatible products by Mitsubishi Electric cannot be guaranteed.

\*6: The total number of modules that can be mounted to a CPU. Refer to the "Maximum number of modules specification" for each module.

(Power supply modules, CPU module, Display unit, Extension module, RS-232 adapter, RS-422/485 adapter, END cover, and END cover with error terminal are not included. Note that only one CPU or head module per system is possible.)

\*7: The END cover is included with the CPU module and must be placed on the right end of the last module in the system.

## ■ CPU module device specifications

Item	L02SCPU L02SCPU-P	L02CPU L02CPU-P	L06CPU L06CPU-P	L26CPU L26CPU-P	L26CPU-BT L26CPU-PBT
Number of I/O device points (number of points available on a program)	8192 points (X/Y0...X/Y1FFF)				
Number of I/O points	1024 points (X/Y0...X/Y3FF)		4096 points (X/Y0...X/YFFF)		
Internal relay (M)	8192 points (M0...M8191) by default (changeable)				
Latch relay (L)	8192 points (L0...L8191) by default (changeable)				
Link relay (B)	8192 points (B0...B1FFF) by default (changeable)				
Timer (T)	2048 points (T0...T2047) by default (changeable) (Low-speed and high-speed timers available) (Low-speed timer: 1...1000 ms (in increments of 1 ms), default: 100 ms) (High-speed timer: 0.1...100 ms (in increments of 0.1 ms), default: 10 ms)				
Retentive timer (ST)	0 point by default (changeable)(Low-speed and high-speed retentive timers available) (Low-speed retentive timer: 1...1000 ms (in increments of 1 ms), default: 100 ms) (High-speed retentive timer: 0.1...100 ms (in increments of 0.1 ms), default: 10 ms)				
Counter (C)	Normal counter 1024 points (C0...C1023) by default (changeable)				
Data register (D)	12288 points (D0...D12287) by default (changeable)				
Extended data register (D)	32768 points (D12288...D45055) by default (changeable)		131072 points (D12288...D143359) by default (changeable)		
Link register (W)	8192 points (W0...W1FFF) by default (changeable)				
Extended link register (W)	0 point by default (changeable)				
Annunciator (F)	2048 points (F0...F2047) by default (changeable)				
Edge relay (V)	2048 points (V0...V2047) by default (changeable)				
Link special relay (SB)	2048 points (SB0...SB7FF) by default (changeable)				
Link special register (SW)	2048 points (SW0...SW7FF) by default (changeable)				
File register	(R)	32768 points (R0...R32767) (Maximum 65536 points are available by switching blocks.)		32768 points (R0...R32767) (Maximum 393216 points are available by switching blocks.)	
	(ZR)	65536 points (ZR0...ZR65535) (Blocks do not need to be switched.)		393216 points (ZR0...ZR393215) (Blocks do not need to be switched.)	
Step relay (S)	8192 points (S0...S8191) by default				
Index register/standard device register (Z)	20 point (Z0...Z19) (maximum)				
Index register (Z) (32-bit index modification of ZR device)	10 point (Z0...Z18) (maximum) (The index register is used as a double-word device.)				
Pointer (P)	4096 points (P0...P4095) (The local pointer range and the common pointer range can be set by parameter.)				
Interrupt pointer (I)	256 points (I0...I255) (The fixed scan interval for the system interrupt pointer I28...I31 can be set by parameter.) 0.5...1000 ms (in increments of 0.5 ms) Default I28: 100 ms, I29: 40 ms, I30: 20 ms, I31: 10 ms				
Special relay (SM)	2048 points (SM0...SM2047) (The number of device points is fixed.)				
Special register (SD)	2048 points (SD0...SD2047) (The number of device points is fixed.)				
Function input (FX)	16 points (FX0...FX F) (The number of device points is fixed.)				
Function output (FY)	16 points (FY0...FY F) (The number of device points is fixed.)				
Function register (FD)	5 points (FD0...FD4) (The number of device points is fixed.)				
Intelligent function module device	Device that directly accesses the buffer memory of an intelligent function module Specification format: U□□/G□□				
Latch (data retention during power failure) range	8192 points (L0...L8191) by default (The latch range can be set for the devices, B, F, V, T, ST, C, D, W, and R by parameter.)				



■ CPU built-in I/O function – input specifications (general-purpose input/interrupt input/pulse catch function)

Item		Description	
Standard input	Points	10	
	Input voltage/current	24 V DC 4.1 mA (TYP.)	
	Minimum input response time	100 μs	
	Input response time setting	0.1 ms, 1 ms, 5 ms, 10 ms, 20 ms, 70 ms	
	Common terminal arrangement	10 points/common (Positive or negative common)	
High-speed input	Points	6	
	Input voltage/current	DC input	24 V DC 6.0 mA (TYP.)
		Differential input	EIA Standard RS-422-A Differential line driver level AM26L31 (manufactured by Texas Instruments Incorporated) or equivalent
	Minimum input response time	10 μs	
	Input response time setting	0.01 ms/0.1 ms/0.2 ms/0.4 ms/0.6 ms/1 ms	
Common terminal arrangement	Independent		

■ CPU built-in I/O function – output specifications (general-purpose output function)

Item		Description
Points		8
Output voltage/current		5...24 V DC 0.1 A
Response time	OFF to ON	≤ 1 μs (rated load, resistance load)
	ON to OFF	
Common terminal arrangement		L02SCPU, L02CPU, L06CPU, L26CPU, L26CPU-BT: 8 points/common (Sink type) L02SCPU-P, L02CPU-P, L06CPU-P, L26CPU-P, L26CPU-PBT: 8 points/common (Source type)

■ CPU built-in I/O function – positioning function specifications

Item		Description	
Number of controlled axes		2	
Control unit		pulse	
Operation pattern	PTP*1 control	Available	
	Path control	Not usable	
Number of positioning data		10 data/axis	
Positioning control	Positioning control method	PTP*1 control	ABS/INC
		Speed/position switching control	INC
	Positioning range	PTP*1 control	-2147483648...2147483647 pulses
		Speed/position switching control	0...2147483647 pulses
	Speed command	0...200k pulses/s	
Acceleration/deceleration system selection		Automatic trapezoid acceleration/deceleration and S-curve acceleration/deceleration	
Acceleration/deceleration time		0...32767 ms	
OPR method		6 types	
Starting time (1-axis linear control)		Trapezoid acceleration/deceleration (single-axis start): 30 μs/axis S-curve acceleration/deceleration (single-axis start): 35 μs/axis	
Command pulse output	Pulse output method		L02SCPU, L02CPU, L06CPU, L26CPU, L26CPU-BT: 5...24V DC (Sink type) L02SCPU-P, L02CPU-P, L06CPU-P, L26CPU-P, L26CPU-PBT: 5...24V DC (Source type)
	Pulse output mode		4 types
	Maximum output pulse		200k pulses/s
	Maximum connection distance with drive unit		2 m
External input	Zero signal	DC input	24 V DC 6.0 mA (TYP.)
		Differential input	EIA RS-422-A differential line driver level AM26L31 (manufactured by Texas Instruments Incorporated) or equivalent
	Speed/position switching signal		24 V DC 4.1 mA (TYP.)
	Near-point dog signal		
	Upper and lower limit signal		
Drive unit ready signal			
Input response time		Zero signal: 10 μs Speed/position switching control, near-point dog signal: 100 μs Upper and lower limit signal, drive unit ready signal: 2 ms	
External output	Deviation counter clear signal		L02SCPU, L02CPU, L06CPU, L26CPU, L26CPU-BT: 5...24 V DC 0.1A (Sink type) L02SCPU-P, L02CPU-P, L06CPU-P, L26CPU-P, L26CPU-PBT: 5...24 V DC 0.1A (Source type)
	Response time	OFF to ON	≤ 1 μs (rated load, resistive load)
ON to OFF			

\*1: Abbreviation for "Point to Point." This is a type of position control.

### ■ CPU built-in I/O function – high-speed counter specifications

Item		Description
Number of channels		2
Count input signal	Phase	1-phase input (1 multiple/2 multiples) CW/CCW, 2-phase input (1 multiple/2 multiples/4 multiples)
	Signal level	DC input Differential input 24 V DC 6.0 mA (TYP.) EIA Standard RS-422-A Differential line driver level AM26L31 (manufactured by Texas Instruments Incorporated) or equivalent
Counter	Maximum counting speed	200k pulses/s (for 2 multiples of 1 phase and 4 multiples of 2 phases)
	Counting range	-2147483648...2147483647
	Model	UP/DOWN preset counter (with ring counter function)
	Minimum count pulse width (Duty ratio 50%)	1 phase: 5 $\mu$ s 2 phases: 10 $\mu$ s
External input	Min. phase differential for 2-phase input	5 $\mu$ s
	Phase Z (preset)	DC input Differential input 24 V DC 6.0 mA (TYP.) EIA Standard RS-422-A Differential line driver level AM26L31 (manufactured by Texas Instruments Incorporated) or equivalent
	Function start	24 V DC 4.1 mA (TYP.)
	Latch	Phase Z: 10 $\mu$ s Function start, latch: 100 $\mu$ s
External output	Input response time	
	Output format	L02SCPU, L02CPU, L06CPU, L26CPU, L26CPU-BT: Sink type L02SCPU-P, L02CPU-P, L06CPU-P, L26CPU-P, L26CPU-PBT: Source type
	Output voltage/current	Coincidence output No. 1 / PWM output Coincidence output No. 2 5...24 V DC/0.25 A*1 5...24 V DC/0.1 A
	Response time	OFF to ON ON to OFF $\leq 1 \mu$ s (Rated load, resistance load)
Coincidence output	Comparison range	-2147483648...2147483647
	Comparison result	Set value < Counted value Set value = Counted value Set value > Counted value
	Output points	2 points/channel
PWM output	Output frequency range	DC...200 kHz
	ON width	1 $\mu$ s
	Duty ratio	On width can be set in increments of 0.1 $\mu$ s.
Pulse width measurement	Output points	1 point/channel
	Measurement item	Pulse width (On width: $\geq 200 \mu$ s, Off width: $\geq 200 \mu$ s)
	Measurement resolution	5 $\mu$ s
	Measurement points	1 point/channel

\*1: For units where the first six digits of the serial number are "120722" or later. The specification for previous serial numbers is 5 to 24 V DC/0.1 A.

### ■ CPU data logging function specifications

Item		L02CPU L02CPU-P	L06CPU L06CPU-P	L26CPU L26CPU-P	L26CPU-BT L26CPU-PBT
Number of data logging settings		10			
Data logging buffer capacity		For each setting, any of 32 to 4832K bytes (in units of 1K byte) can be specified. The total value of settings No.1 to No.10 is up to 5120K bytes.			
Data storage location		Standard ROM (configuration files only), SD Memory Card			
Logging type		<ul style="list-style-type: none"> <li>Continuous logging</li> <li>Trigger logging</li> </ul>			
Data sampling	Sampling interval	<ul style="list-style-type: none"> <li>Each scanning cycle</li> <li>Time specification</li> <li>Condition specification (Device specification, Step No. specification)</li> </ul>			
	No. of data sampling points	Up to 1280 (128 points per setting)			
AND conjunction		In the Sampling interval setting, Device and Step No. under "Condition specification" can be specified in combination (AND conjunction).			
Data processing	Trigger logging	Trigger condition	<ul style="list-style-type: none"> <li>Condition specification (Device change specification, Step No. specification)</li> <li>When trigger instruction executed</li> <li>When data logging trigger activated</li> </ul>		
		AND conjunction	In the Trigger setting, Device data change and Step No. under "Condition specification" can be specified in combination (AND conjunction).		
	Trigger logging range	Data of the specified number of records are logged before and after a trigger.			
	Number of triggers	1			
Number of trigger logging records		Up to 1000000			
File output	File name	Up to 48 one-byte characters can be used for the following. • File number (serial number)*2 • Character string (name)*3 • Date and time*3			
	File format	CSV file			
	Data type	<ul style="list-style-type: none"> <li>Bit</li> <li>Double word (unsigned)</li> <li>FLOAT (double precision)</li> </ul>	<ul style="list-style-type: none"> <li>Word (unsigned)</li> <li>Double word (signed)</li> <li>Character string: 1...256 characters</li> </ul>	<ul style="list-style-type: none"> <li>Word (signed)</li> <li>FLOAT (single precision)</li> <li>Numeric string: 1...256 bytes</li> </ul>	
Data output format (CSV file)		<ul style="list-style-type: none"> <li>Decimal format</li> </ul>	<ul style="list-style-type: none"> <li>Hexadecimal format</li> </ul>	<ul style="list-style-type: none"> <li>Exponential format</li> </ul>	
Handling of output files	File switching	File switching timing	No. of records	File size	
		Number of saved files	1...65535		

\*2: Part of the saved file name, this number is automatically assigned.

\*3: Optional data to be appended to the saved file name.

### ■ CPU built-in Ethernet function specifications

Item		L02CPU L02CPU-P	L06CPU L06CPU-P	L26CPU L26CPU-P	L26CPU-BT L26CPU-PBT
Transmission specifications	Data transfer speed	100 or 10 Mbps			
	Communication mode	Full-duplex or half-duplex			
	Transmission method	Base band			
	Maximum distance between hub and node	100 m			
	Maximum number of nodes/connection	10BASE-T	Cascade connection: Up to four		
	100BASE-TX	Cascade connection: Up to two			
Number of connections	TCP/IP	Total of 16 for socket communications, MELSOFT connections, and MC protocol.*1			
	UDP/IP	One for FTP			
Connection cable*2	10BASE-T	Ethernet cable of category 3 or higher (STP/UTP cable)*3			
	100BASE-TX	Ethernet cable of category 5 or higher (STP cable)			

\*1: Only the QnA-compatible 3E frame may be used.

\*2: Standard (straight type) cable. Also, when the CPU is connected directly with a GOT(HMI), a cross cable (category 5e or less) may be used.

\*3: The use of STP (Shielded Twisted Pair) cables is recommended in noisy environments.

### ■ Communication performance comparison (Comparison of LCPU with built-in Ethernet port and Ethernet interface module)

Function/performance	LCPU with built-in Ethernet port	Ethernet interface module
Communication speed	100 Mbps	100 Mbps
MC protocol communication	●*4	●
Socket communication	●*5	(Fixed buffer communication)
Communications using a random access buffer	—	●
E-mail function	—	●
Communications using data link instructions	—	●
File transfer (FTP server) function	●*6	●
Web function	—	●
MELSOFT products and GOT(HMI) connection	●	●

\*4: QnA compatible 3E frame device memory access commands only. Refer to the relevant manual for details.

\*5: There are some differences regarding the fixed buffer communications function. Refer to the relevant manual for details.

\*6: The "quote cpuchg" command is not supported.

### ■ CPU built-in serial communication function specifications

Item	L02SCPU L02SCPU-P
Communication mode	Full duplex
Synchronization method	Asynchronous method
Transmission speed	9.6 kbps, 19.2 kbps, 38.4 kbps, 57.6 kbps, 115.2 kbps
Data format	<ul style="list-style-type: none"> <li>Start bits: 1</li> <li>Data bits: 8</li> <li>Parity bits: Odd number</li> <li>Stop bits: 1</li> </ul>
MC protocol format *7 (automatic judgment)	<ul style="list-style-type: none"> <li>Formats 4 (ASCII)</li> <li>Formats 5 (Binary)</li> </ul>
Frame *7	<ul style="list-style-type: none"> <li>QnA compatible 3C frame</li> <li>QnA compatible 4C frame</li> </ul>
Transmission control	DTR/DSR control
Transmission distance (Overall distance)	Maximum 15 m

\*7: Information relevant to the MC protocol format and frame are shown below.

Function		Formats 4	Formats 5
Communication with ASCII code	QnA compatible 3C frame	●	—
	QnA compatible 4C frame	●	—
Communication with binary code	QnA compatible 4C frame	●	●

### ■ How to read the product code

**L 26 □ CPU - P BT - SET**

①    ②    ③    ④    ⑤    ⑥

Number	Item	Code	Specification
①	Program memory capacity	02	20K steps
		06	60K steps
		26	260K steps
②	Communication interface	Blank	Built-in Ethernet model
		S	Built-in RS-232 model
③	Type of module	CPU	CPU module
④	Built-in I/O output format	Blank	Sink type
		P	Source type
⑤	Built-in CC-Link function	Blank	—
		BT	●
⑥	Product set	Blank	—
		SET	Set includes a power supply module (L61P) and display unit (L6DSPU)

## Branch/Extension Modules



### Branch and extension module specifications

Item	L6EXB [ Branch module ]	L6EXE [ Extension module ]
5 V DC internal current consumption	0.08 A	0.08 A
Weight	0.12 kg	0.13 kg

### Extension cable specifications

Item	LC06E	LC10E	LC30E
Cable length	0.6 m	1.0 m	3.0 m
Weight	0.19 kg	0.23 kg	0.45 kg

## Power Supply Modules

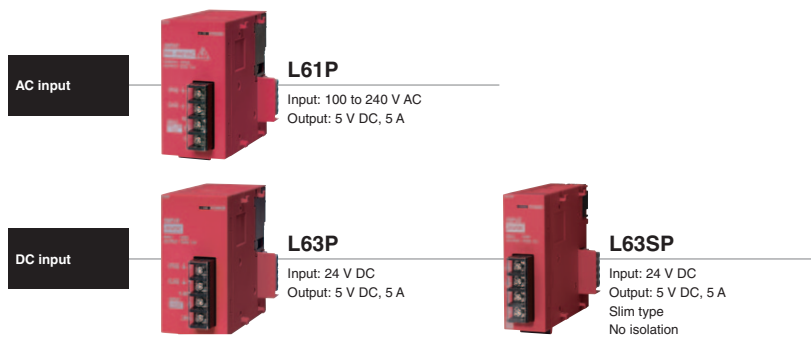

### Power supply module specifications

Item	L61P	L63P	L63SP
Input power supply	100...240 V AC (-15%...+10%)	24 V DC (-35%...+30%)	
Input frequency	50/60 Hz (-5%...+5%)	—	
Input voltage distortion	≤ 5%	—	
Maximum input apparent power	130 VA	—	
Maximum input power	—	45 W	
Inrush current	20 A, ≤ 8 ms	100 A, ≤ 1 ms (24 V DC input)	
Rated output current (5 V DC)	5 A		
Overcurrent protection (5 V DC)	≥ 5.5 A		
Overvoltage protection	5.5...6.5 V		
Efficiency	≥ 70%		
Allowable momentary power failure time	≤ 10 ms		≤ 10 ms (24 V DC input)
Withstand voltage	2300 V AC per minute (altitude 0...2000 m) Between the combined "line input/LG terminals" and the "FG terminal and output".	510 V AC per minute (altitude 0...2000 m) Between the combined "line input/LG terminals" and the "FG terminal and output".	—*1
Insulation resistance	10 MΩ or higher by 500 V DC insulation resistance tester • Between the combined "line input/LG terminals" and the "FG terminal and output". • The line input and LG terminals. • The FG terminal and output.		—*1
Weight	0.32 kg	0.29 kg	0.19 kg

\*1: There is no isolation between the primary side 24 V DC and secondary side 5 V DC.

## RS-232 Adapter

RS-232 adapter



### L6ADP-R2

Transmission speed: 115.2 kbps  
GOT(HMI) connection  
MELSOFT<sup>TM</sup> connection

Predefined protocol support function  
Serial communication function

**MODBUS®**

\*1: Please refer to each MELSOFT product manual for details on the supported software.

### ■ RS-232 adapter specifications

Item	Specification
Maximum data transmission speed	115.2 kbps
5 V DC internal current consumption	0.02 A
Weight	0.10 kg

## RS-422/485 Adapter

RS-422/485 adapter



### L6ADP-R4

Transmission speed: 115.2 kbps  
GOT(HMI) connection

Predefined protocol support function  
Serial Communication function

**MODBUS®**

### ■ RS-422/485 adapter specifications

Item	Specification
Maximum data transmission speed	115.2 kbps
5 V DC internal current consumption	0.15 A
Weight	0.12 kg

## END Cover with Error Terminal

END cover with error terminal



### L6EC-ET

Error output relay

### ■ END cover with error terminal specifications

Item	Specification		
ERR. terminal	Rated switching voltage, current	24 V DC 0.5 A	
	Minimum switching load	5 V DC, 1 mA	
	Response time	OFF to ON	≤ 10 ms
		ON to OFF	≤ 12 ms
	Life	Mechanical	≥ 20 million times
		Electrical	Rated switching voltage/current: 10 million times or more
Surge suppressor	—		
Fuse	—		
Applicable wire size	0.3...2.0 mm <sup>2</sup> (AWG22...14) (Twisted wire/Solid wire)		
External interface	Spring clamp terminal block		
5 V DC internal current consumption	0.06 A		
Weight	0.11 kg		

## Display Unit

Display unit







### L6DSPU

### ■ Display Unit specifications

Item	Specification
Number of displayed characters	16 one-byte characters × 4 lines
Displayed characters	<ul style="list-style-type: none"> <li>• Alphanumeric (two-byte/one-byte character)</li> <li>• Japanese character Katakana (two-byte/one-byte character)</li> <li>• Japanese character Hiragana (two-byte character)</li> <li>• Chinese character (two-byte character)</li> <li>• Symbol (two-byte/one-byte character)</li> </ul>
Language	Japanese/English
Backlight	Green (normal), red (error)
Weight	0.03 kg



## Input Modules

AC input		<b>LX10</b> Number of inputs: 16 points 100 to 120 V AC 18-point terminal block		<b>LX28</b> Number of inputs: 8 points 100 to 240 V AC 18-point terminal block
	DC input		<b>LX40C6</b> Number of inputs: 16 points 24 V DC 18-point terminal block	
		<b>LX42C4</b> Number of inputs: 64 points 24 V DC 40-pin connector x2		

## Output Modules

Contact output		<b>LY10R2</b> Number of outputs: 16 points 24 V DC/240 V AC Rated switching current: 2 A/point 18-point terminal block		<b>LY18R2A</b> <span style="color: red;">NEW</span> Number of outputs: 8 points (all points independent) 24 V DC/240 V AC Rated switching current: 2 A/point 18-point terminal block
	Triac output		<b>LY20S6</b> Number of outputs: 16 points 100 to 240 V AC Max. load current: 0.6 A/point 18-point terminal block	
Transistor output (Sink type)			<b>LY40NT5P</b> Number of outputs: 16 points 12 to 24 V DC Max. load current: 0.5 A/point Protection function 18-point terminal block	
		<b>LY42NT1P</b> Number of outputs: 64 points 12 to 24 V DC Max. load current: 0.1 A/point Protection function 40-pin connector x2		
Transistor output (Source type)		<b>LY40PT5P</b> Number of outputs: 16 points 12 to 24 V DC Max. load current: 0.5 A/point Protection function 18-point terminal block		<b>LY41PT1P</b> Number of outputs: 32 points 12 to 24 V DC Max. load current: 0.1 A/point Protection function 40-pin connector
		<b>LY42PT1P</b> Number of outputs: 64 points 12 to 24 V DC Max. load current: 0.1 A/point Protection function 40-pin connector x2		

## I/O Combined Modules

DC input / Transistor output (Sink type)		<b>LH42C4NT1P</b>	Input specifications Number of inputs: 32 points 24 V DC 40-pin connector	Output specifications Number of outputs: 32 points 12 to 24 V DC Max. load current: 0.1 A/point Protection function 40-pin connector
		DC input / Transistor output (Source type)		<b>LH42C4PT1P</b>

### Spring clamp terminal block (push-in type): L6TE-18S NEW

The screw terminal block of installed modules can be replaced with a push-in type spring clamp terminal block. This terminal block type helps to reduce the amount of wiring and maintenance time.

- Push-in type for reduced wiring  
Easier to wire just by inserting into the terminal block.

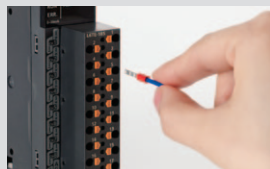

- Simple to confirm signal integrity  
Includes dedicated terminals for insertion of a test probe, for example.

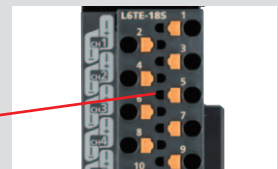

## Input module specifications

### AC input module

Item	LX10	LX28
Number of input points	16 points	8 points
Rated input voltage, frequency	100...120 V AC (+10%/-15%), 50/60Hz (±3 Hz)	100...240 V AC (+10%/-15%), 50/60 Hz(±3 Hz)
Input voltage distortion	≤ 5%	
Rated input current	8.2 mA (100 V AC, 60 Hz), 6.8 mA (100 V AC, 50 Hz)	16.4 mA (200 V AC, 60 Hz), 13.7 mA (200 V AC, 50 Hz), 8.2 mA (100 V AC, 60 Hz), 6.8 mA (100 V AC, 50 Hz)
Inrush current	Max. 200 mA ≤ 1 ms	Max. 950 mA ≤ 1 ms
ON voltage/ON current	≥ 80 V AC / ≥ 5 mA (50 Hz, 60 Hz)	
OFF voltage/OFF current	≤ 30 V AC / ≤ 1.7 mA (50 Hz, 60 Hz)	
Input resistance	12.2 kΩ (60 Hz), 14.6 kΩ (50 Hz)	
Response time	OFF to ON	≤ 15 ms (100 V AC 50 Hz, 60 Hz) ≤ 10 ms (200 V AC 50 Hz, 60 Hz)
	ON to OFF	≤ 20 ms (100 V AC 50 Hz, 60 Hz) ≤ 20 ms (100/200 V AC 50 Hz, 60 Hz)
Common terminal arrangement	16 points/common	8 points/common
Module size allocation	1	
Number of occupied I/O points	16 points (I/O assignment: input 16 points)	
External interface	18-point terminal block	
5 V DC internal current consumption	90 mA (TYP. all points ON)	80 mA (TYP. all points ON)
Weight	0.17 kg	0.15 kg

### DC input module

Item	LX40C6	LX41C4	LX42C4
Number of input points	16 points	32 points	64 points
Rated input voltage	24 V DC (ripple rate: ≤ 5%) (allowable voltage range: 20.4...28.8 V DC)		
Rated input current	6.0 mA TYP. (at 24 V DC)	4.0 mA TYP. (at 24 V DC)	
ON voltage/ON current	≥ 15 V DC / ≥ 4 mA	≥ 19 V DC / ≥ 3 mA	
OFF voltage/OFF current	≤ 8 V DC / ≤ 2 mA	≤ 9 V DC / ≤ 1.7 mA	
Input resistance	3.8 kΩ	5.7 kΩ	
Response time	OFF to ON	1 ms, 5 ms, 10 ms, 20 ms, 70 ms or less Initial setting is 10 ms.	
	ON to OFF		
Common terminal arrangement	16 points/common	32 points/common	
Module size allocation	1		
Number of occupied I/O points	16 points (I/O allocation: input 16 points)	32 points (I/O assignment: input 32 points)	64 points (I/O allocation: input 64 points)
External interface	18-point terminal block	40-pin connector	40-pin connector × 2
5 V DC internal current consumption	90 mA (TYP. all points ON)	100 mA (TYP. all points ON)	120 mA (TYP. all points ON)
Weight	0.15 kg	0.11 kg	0.12 kg

## Output module specifications

### Contact output module

Item	LY10R2	LY18R2A <small>NEW</small>	
Number of output points	16 points	8 points	
Rated switching voltage, current	24 V DC 2 A (resistive load)/point, 8 A/common 240 V AC 2 A (COSφ=1)/point, 8 A/common	24 V DC 2 A (resistive load)/point, 8 A/module 240 V AC 2 A (COSφ=1)/point, 8 A/module	
Minimum switching load	5 V DC 1 mA		
Maximum switching load	264 V AC 125 V DC		
Response time	OFF to ON	≤ 10 ms	
	ON to OFF	≤ 12 ms	
Life	Electrical	≥ 20 million times	
		Usage environment	Switching life
		Rated switching voltage/current, rated load	100 thousand times
		200 V AC 1.5 A, 240 V AC 1 A (COSφ = 0.7)	100 thousand times
		200 V AC 0.4 A, 240 V AC 0.3 A (COSφ = 0.7)	300 thousand times
		200 V AC 1 A, 240 V AC 0.5 A (COSφ = 0.35)	100 thousand times
		200 V AC 0.3 A, 240 V AC 0.15 A (COSφ = 0.35)	300 thousand times
24 V DC 1 A, 100 V DC 0.1 A (L/R = 7 ms)	100 thousand times		
24 V DC 0.3 A, 100 V DC 0.03 A (L/R = 7 ms)	300 thousand times		
Maximum switching frequency	3600 times/hour		
Surge suppressor	—		
Fuse	—	(a fuse is recommended to be installed for each external wiring point)	
Common terminal arrangement	16 points/common	No common (all points independent)	
Module size allocation	1		
Number of occupied I/O points	16 points (I/O assignment: 16 output points)		
External interface	18-point terminal block		
5 V DC internal current consumption	460 mA (TYP. all points ON)	260 mA(TYP.all points ON)	
Weight	0.21 kg	0.18 kg	

## Output module specifications

### Triac output

Item	LY20S6	LY28S1A <b>NEW</b>
Number of output points	16 points	8 points
Rated load voltage, frequency	100...240 V AC (+10%/-15%), 50/60 Hz(±3 Hz)	
Maximum load current	0.6 A/point, 4.8 A/common	1 A/point, 8 A/module
Load voltage distortion ratio	≤ 5%	
Maximum load voltage	264 V AC	
Minimum load voltage/current	24 V AC/100 mA, 100 V AC/25 mA, 240 V AC/25 mA	
Maximum inrush current	≤ 20 A/cycle	
Leakage current at OFF	≤ 3 mA (at 240 V, 60 Hz), ≤ 1.5 mA (at 120 V, 60 Hz)	
Maximum voltage drop at ON	≤ 1.5 V (at load current of 0.6 A)	
Response time	Total of 1 ms and 0.5 cycles or less	
	OFF to ON	Total of 1 ms and 0.5 cycles or less (rated load, resistive load)
	ON to OFF	
Surge suppressor	CR absorber	
Fuse	None (Attaching a fuse to each external wiring is recommended.)	
Common terminal arrangement	16 points/common	No common (all points independent)
Module size allocation	1	
Number of occupied I/O points	16 points (I/O assignment: output 16 points)	
External interface	18-point terminal block	
5 V DC internal current consumption	300 mA (TYP. all points ON)	200 mA (TYP. all points ON)
Weight	0.22 kg	0.19 kg

### Transistor output (Sink type)

Item	LY40NT5P	LY41NT1P	LY42NT1P	
Number of output points	16 points	32 points	64 points	
Rated load voltage	10.2...28.8 V DC			
Maximum load current	0.5 A/point, 5 A/common	0.1 A/point, 2 A/common		
Maximum inrush current	Current is limited by the overload protection function.			
Leakage current at OFF	≤ 0.1 mA			
Maximum voltage drop at ON	0.2 V DC(TYP.) 0.5 A, 0.3 V DC(MAX.) 0.5 A	0.1 V DC (TYP.) 0.1 A, 0.2 V DC (MAX.) 0.1 A		
Response time	≤ 0.5 ms			
	OFF to ON	≤ 1 ms (rated load, resistance load)		
	ON to OFF			
Surge suppressor	Zener diode			
Fuse	—			
External power supply	12/24 V DC (ripple rate: ≤ 5%) (allowable voltage range: 10.2...28.8 V DC)			
	Voltage			
	Current	9 mA (at 24 V DC)/common	13 mA (at 24 V DC)/common	9 mA (at 24 V DC)/common
Common terminal arrangement	16 points/common	32 points/common		
Module size allocation	1			
Number of occupied I/O points	16 points (I/O assignment: 16 output points)	32 points (I/O assignment: 32 output points)	64 points (I/O assignment: 64 output points)	
Protection function	Overload protection	Limited current when detecting overcurrent (overload protection): 1.5...3.5 A/point. Activated in increments of 1 point.		
	Overheat protection	Activated in increments of 1 point		
External interface	18-point terminal block	40-pin connector	40-pin connector x2	
5 V DC internal current consumption	100 mA (TYP. all points ON)	140 mA (TYP. all points ON)	190 mA (TYP. all points ON)	
Weight	0.15 kg	0.11 kg	0.12 kg	

### Transistor output (Source type)

Item	LY40PT5P	LY41PT1P	LY42PT1P	
Number of output points	16 points	32 points	64 points	
Rated load voltage	10.2...28.8 V DC			
Maximum load current	0.5 A/point, 5 A/common	0.1 A/point, 2 A/common		
Maximum inrush current	Current is limited by the overload protection function.			
Leakage current at OFF	≤ 0.1 mA			
Maximum voltage drop at ON	0.2 V DC(TYP.)0.5 A, 0.3 V DC(MAX.)0.5 A	0.1 V DC (TYP.) 0.1 A, 0.2 V DC (MAX.) 0.1 A		
Response time	≤ 0.5 ms			
	OFF to ON	≤ 1 ms (rated load, resistance load)		
	ON to OFF			
Surge suppressor	Zener diode			
Fuse	—			
External power supply	12/24 V DC (ripple rate: ≤ 5%) (allowable voltage range: 10.2...28.8 V DC)			
	Voltage			
	Current	17 mA (at 24 V DC)/common	20 mA (at 24 V DC)/common	
Common terminal arrangement	16 points/common	32 points/common		
Module size allocation	1			
Number of occupied I/O points	16 points (I/O assignment: 16 output points)	32 points (I/O assignment: 32 output points)	64 points (I/O assignment: 64 output points)	
Protection function	Overload protection	Overcurrent detection: ≥ 1.5 A/point. Activated in increments of 1 point.		
	Overheat protection	Activated in increments of 1 point.		
External interface	18-point terminal block	40-pin connector	40-pin connector x2	
5 V DC internal current consumption	100 mA (TYP. all points ON)	140 mA (TYP. all points ON)	190 mA (TYP. all points ON)	
Weight	0.15 kg	0.11 kg	0.12 kg	



## I/O combined module specifications DC input/transistor output combined module

Item	LH42C4NT1P	LH42C4PT1P
<b>Input specifications</b>		
Number of input points	32 points	
Rated input voltage	24 V DC (ripple rate: ≤ 5%) (allowable voltage range: 20.4...28.8 V DC)	
Rated input current	4.0 mA TYP. (at 24 V DC)	
Input ON voltage/ON current	≥ 19 V DC/≥ 3 mA	
Input OFF voltage/OFF current	≤ 9 V DC/≤ 1.7 mA	
Input resistance	5.7 kΩ	
Input response time	1 ms, 5 ms, 10 ms, 20 ms, 70 ms or less (Initial setting is 10 ms)	
Input common terminal arrangement	32 points/common	
<b>Output specifications</b>		
Output format	Transistor output combined module (Sink type)	Transistor output combined module (Source type)
Number of output points	32 points	
Rated load voltage	10.2...28.8 V DC	
Maximum load current	0.1 A/point, 2 A/common	
Maximum inrush current	Current is limited by the overload protection function.	
Leakage current at OFF	≤ 0.1 mA	
Maximum voltage drop at ON	0.1 V DC (TYP.) 0.1 A, 0.2 V DC (MAX.) 0.1 A	
Output response time	≤ 0.5 ms	
Surge suppressor	Zener diode	
Fuse	—	
Protection function	Overload protection	Limited current when detecting overcurrent (overload protection): 1...3 A/point, activated in increments of 1 point
	Overheat protection	Activated in increments of 1 point
Output common terminal arrangement	32 points/common	
<b>Common specifications</b>		
External power supply	Voltage	12/24 V DC (ripple rate: ≤ 5%) (allowable voltage range: 10.2...28.8 V DC)
	Current	9 mA (at 24 V DC)/common
Module size allocation	1	
Number of occupied I/O points	32 points (I/O assignment: input/output 32 points)	
External interface	40-pin connector x2	
5 V DC internal current consumption	160 mA (TYP. all points ON)	150 mA (TYP. all points ON)
Weight	0.12 kg	

### How to read the product code

• For input module or output module

• For I/O combined module

**L Y 4 0 NT 5 P**      **L H 4 2 C4 NT1 P**

① ② ③ ④ ⑤ ⑥      ① ② ③ ④ ⑤ ④ ⑤ ⑥

Number	Item	Code	Specification					
①	Module type	X	Input					
		Y	Output					
		H	I/O combined					
②	Voltage specification	Code	Input specifications		Output specifications			
			AC input	DC input	Contact output	Triac output	Transistor output	
		1	100...120 V AC	—	24 V DC/240 V AC	—	—	
		2	100...240 V AC	—	—	100...240 V AC	—	
4	—	24 V DC	—	—	12...24 V DC			
③	I/O points	Code	Specification					
			0	16 points				
			1	32 points				
			2	64 points				
8	8 points							
④	I/O type	Code	Specification					
			Blank	AC input				
			C	DC input (positive/negative shared common)				
			NT	Transistor output module (Sink type)				
			PT	Transistor output module (Source type)				
			R	Contact output				
S	Triac output							
⑤	Current specification	Code	Input specifications		Output specifications			
			AC input	DC input	Contact output	Triac output	Transistor output	
			1	—	—	—	1 A	0.1 A
			2	—	—	2 A	—	—
			4	—	4 mA	—	—	—
			5	—	—	—	—	0.5 A
6	—	6 mA	—	0.6 A	—			
⑥	Extra specifications	Code	Specification					
			P	Includes protection function				
A	Independent common							

## Multiple Input (Voltage/Current/Temperature) Module

Channel isolated multiple input



### L60MD4-G NEW

Number of inputs: 4 channels  
 Input voltage: -10 to 10 V DC  
 Input current: 0 to 20 mA DC  
 Input micro voltage: -100 to 100 mV  
 Input thermocouple: K, J, T, E, N, R, S, B, U, L, PL II, W5Re/W26Re  
 Input RTD: Pt1000, Pt100, JPt100, Pt50  
 Conversion speed: 50 ms/channel  
 Resolution  
 Voltage/Current/micro voltage: 1/20000  
 Thermocouple: B, R, S, N, PL II, W5Re/W26Re: 0.3°C,  
 K, E, J, T, U, L: 0.1°C  
 RTD: Pt100, JPt100: 0.03°C/0.1°C,  
 Pt1000, Pt50: 0.1°C

## Analog Input Modules

Analog Input



### L60AD4

Number of inputs: 4 channels  
 Input voltage: -10 to 10 V DC  
 Input current: 0 to 20 mA DC  
 Conversion speed: 20 µs/channel  
 Resolution: 1/20000



### L60ADVL8 NEW

Number of inputs: 8 channels  
 Input voltage: -10 to 10 V DC  
 Conversion speed: 1 ms/channel  
 Resolution: 1/16000



### L60ADIL8 NEW

Number of inputs: 8 channels  
 Input current: 0 to 20 mA DC  
 Conversion speed: 1 ms/channel  
 Resolution: 1/8000

Dual channel Isolation Analog Input



### L60AD4-2GH

Number of inputs: 4 channels  
 Input voltage: -10 to 10 V DC  
 Input current: 0 to 20 mA DC  
 Conversion speed: 40 µs/2 channels  
 Resolution: 1/32000

## Analog Output Module

Analog Output



### L60DA4

Number of outputs: 4 channels  
 Output voltage: -10 to 10 V DC  
 Output current: 0 to 20 mA DC  
 Conversion speed: 20 µs/channel  
 Resolution: 1/20000

## Analog I/O Module

Analog I/O



### L60AD2DA2

Analog input specifications  
 Number of inputs: 2 channels  
 Input voltage: -10 to 10 V DC  
 Input current: 0 to 20 mA DC  
 Conversion speed: 80 µs/channel  
 Resolution: 1/12000

Analog output specifications  
 Number of outputs: 2 channels  
 Output voltage: -10 to 10 V DC  
 Output current: 0 to 20 mA DC  
 Conversion speed: 80 µs/channel  
 Resolution: 1/12000

■ Multiple/analog input features

Function		Multiple input (voltage/ current/temperature) module	Analog input module				Analog I/O module
		L60MD4-G <b>NEW</b>	L60AD4	L60ADVL8 <b>NEW</b>	L60ADIL8 <b>NEW</b>	L60AD4-2GH	L60AD2DA2
Channel isolation		●	—	—	—	● <sup>*1</sup>	—
AD conversion method	Sampling processing	●	●	●	●	●	●
	Averaging processing	Time average	●	●	●	●	●
		Count average	●	●	●	●	●
		Moving average	●	●	●	●	●
Time lag filter function		—	—	—	—	●	—
Digital filtering function		—	—	—	—	●	—
Conversion speed switch function		—	●	—	—	—	—
Input range extended mode function		●	● <sup>*2</sup>	●	●	●	●
Maximum value/minimum value hold function		●	●	●	●	●	●
Disconnection detection function		●	—	—	—	—	—
Input signal error detection function		●	●	●	●	●	●
Input signal error detection extension function		—	● <sup>*2</sup>	●	●	—	—
Warning output function	Process alarm	●	●	●	●	●	—
	Rate alarm	●	—	—	—	●	—
Scaling function		●	●	●	●	●	●
Shift function		— <sup>*3</sup>	● <sup>*2</sup>	— <sup>*3</sup>	— <sup>*3</sup>	●	— <sup>*3</sup>
Digital clipping function		— <sup>*3</sup>	●	— <sup>*3</sup>	— <sup>*3</sup>	●	— <sup>*3</sup>
Difference conversion function		— <sup>*3</sup>	● <sup>*2</sup>	— <sup>*3</sup>	— <sup>*3</sup>	●	— <sup>*3</sup>
Logging function		— <sup>*4</sup>	● <sup>*2</sup>	— <sup>*4</sup>	— <sup>*4</sup>	●	●
Flow amount integration function		—	● <sup>*2</sup>	—	—	—	—
Trigger conversion function		—	—	—	—	●	—

\*1: Every two channels are isolated. (CH1 and CH2 are isolated from CH3 and CH4).

\*2: Supported by models whose first five serial number digits are "13041" or later.

\*3: Please use function blocks (FB) for the shift function, digital clipping function, and difference conversion function. The function blocks (FB) can be downloaded for free from the MELSOFT Library on the Mitsubishi Electric FA site.

\*4: For logging, please use the data logging function of the CPU module.

■ Analog output features

Function		Analog output module	Analog I/O module
		L60DA4	L60AD2DA2
Analog output HOLD/CLEAR function		●	●
Scaling function		●	●
Warning output function	Process alarm	●	●
	Wave output step action function	● <sup>*5</sup>	●

\*5: Supported by models whose first five serial number digits are "14041" or later.

**Easily and finely adjust the system startup time with the shift function**

**Shift function**

Using this function, the set shifting amount to conversion value can be added (shifted) to the digital output value. When the shifting amount to conversion value is changed, it is reflected to the scaling value (digital operation value) in real time. Therefore, fine adjustment can be easily performed when the system starts.

For L60AD4

■ Before adjustment	
Input voltage (V)	Digital output value
0	-10
5	19990

▼ Shifting amount to conversion value: +10

■ After adjustment	
Input voltage (V)	Scaling value (digital operation value)
0	0
5	20000

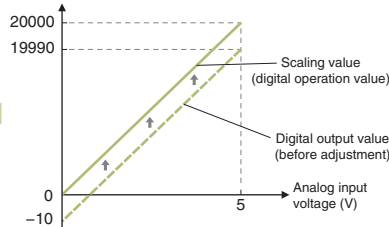
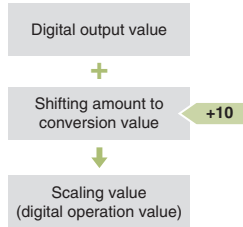

**Reduce the time taken for programming**

**Scaling function**

The scaling function converts values directly to easy-to-understand units without requiring any programming. Since a separate conversion program is not required, the number of overall programming steps can be reduced.

**Scaling settings example (L60AD4)**

Normally an analog input of 4 to 20 mA is converted to a digital value from 0 to 20000. Using the scaling feature, the same input can result in a digital value of ±20000.

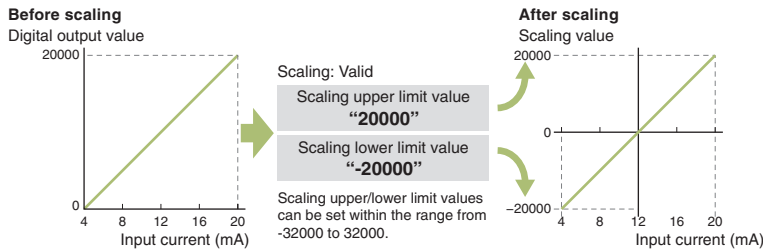

Input current (mA)	Digital output value	Scaling value
4	0	-20000
8	5000	-10000
12	10000	0
16	15000	10000
20	20000	20000

**Digital filtering function**

This function eliminates unnecessary frequency elements with simple parameter settings. Select from low pass filter, high pass filter or band pass filter.

Programming steps can be further reduced as extra ladder code is not required to achieve the filter processing. The filtered A/D conversion program is available at the same time as conversion completion, reducing the overall conversion to filter process time.

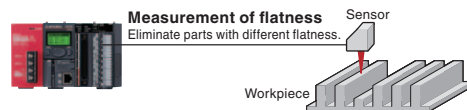
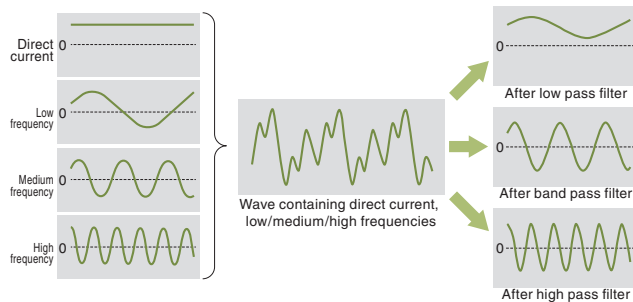

■ When low pass is processed with ladder  
When requiring a filter processing program, more than 300 lines are necessary.

Not required when using digital filter function

■ Total time when processing digital filter with ladder

Processing time is reduced by using the digital filter function

A/D conversion time | Program processing time (filter process)

**First-delay filter function**

The first-delay filter function constant outputs a digital value which filters out (smooths) the excessive noise.

## Log data for up to 10,000 points

### Logging function

Data is continuously collected at the set cycle and stored in the buffer memory.

Data stored in the buffer memory can be used for debugging, and to periodically confirm data variations.

Item	Description		
	L60AD4	L60AD4-2GH	L60AD2DA2
Collectable points	10000 points/channel		
Collectable data	Digital output value or scaling value (digital operation value)		
Logging cycle*1	80...32767 μs	40...32767 μs	80...32767 μs
	1...32767 ms	1...32767 ms	1...32767 ms
	1...3600 s	1...3600 s	1...3600 s
Conversion speed	80 μs, or 1 ms	40 μs/2 channels	80 μs
Level trigger condition	Above, Below, Pass Through		
Logging points after trigger	1...10000		

\*1: The actual logging cycle is "an integral multiple of the conversion cycle of each A/D conversion method".  
 Ex.) When using the sampling processing: Conversion cycle = conversion speed x number of channels in use.

The logging data can be analyzed with the GX LogViewer.

### When an error is detected in the digital value:

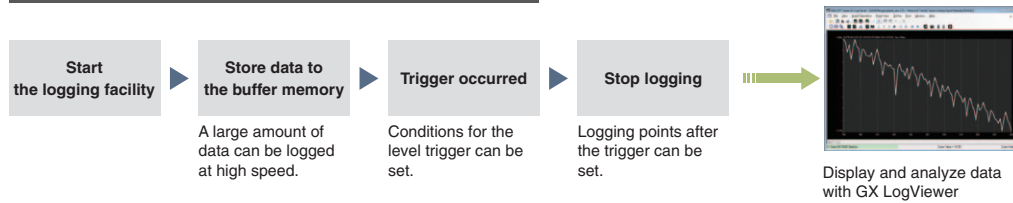

Logging data can be transferred to the CPU device memory while still logging.

Logging and data transmission can be executed simultaneously so the next logging session can be started right away.

### Logging for 10,000 points and greater

When logging of 1001 - 2000 points of data commences, the first 1000 points (1 - 1000) are stored into the CPU device memory. By storing every 1000 points of data in the CPU, overall logging of total data larger than 1000 points can be logged.

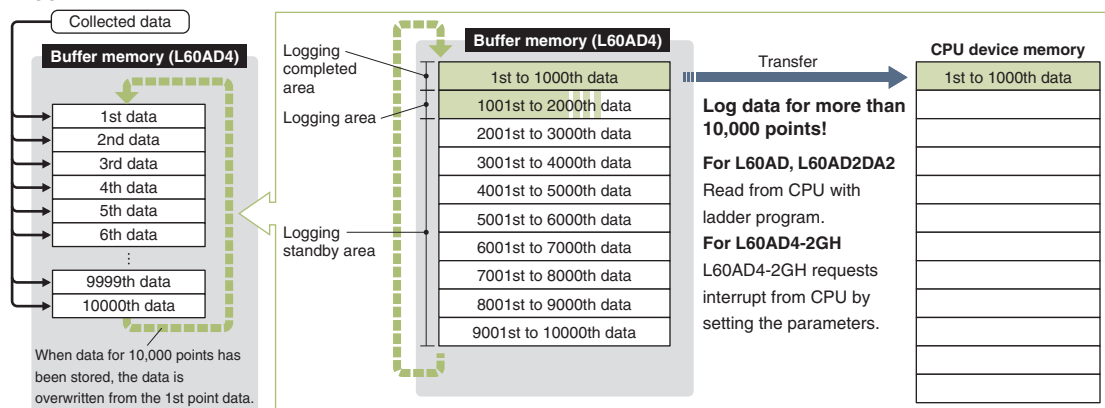

## Easily measure part thicknesses!

### Difference conversion function

When the difference conversion starts, the scaling value (digital operation value) at that time is determined as the difference conversion reference value. The value acquired by subtracting the difference conversion reference value from the scaling value (digital operation value) is stored as the scaling value (digital operation value) after difference conversion.

### For L60AD4

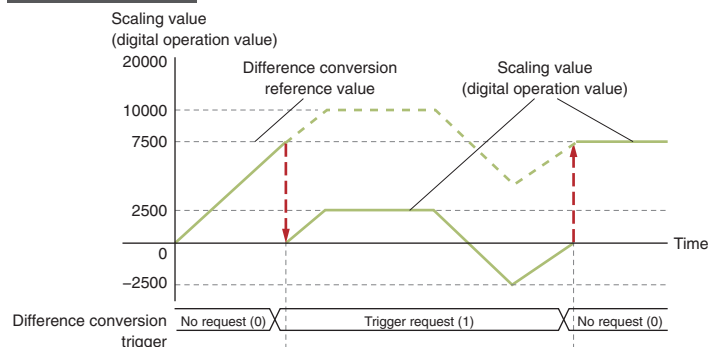

$$\text{Scaling value (digital operation value) after difference conversion} = \text{Scaling value (digital operation value)} - \text{Difference conversion reference value}$$

**Extend the detection method according to applications**

**Input signal error detection extension function**

Using this function, the detection method of the input signal error detection function can be extended. Use this function to detect an input signal error only at the lower or upper limit, or to execute the disconnection detection.

**Input range extension function**

The input range can be extended. By combining this function with the input signal error detection function, simple disconnection detection can be executed.

**Connected devices monitoring alarm**

**Warning output function**

■ **Process alarm**

Outputs an alarm when the digital output value enters a preset alarm range.

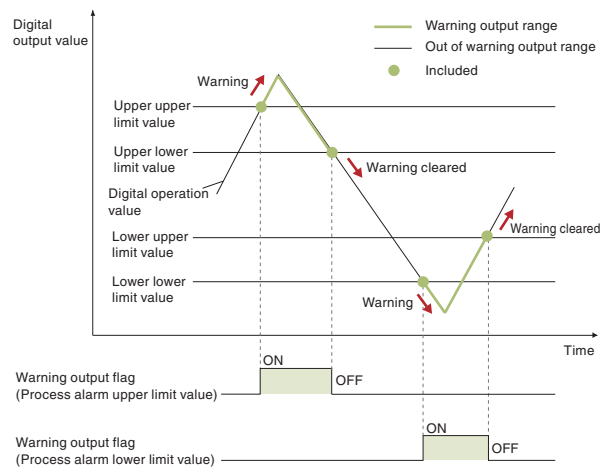

■ **Rate alarm**

An alarm is generated if the digital output value's variation rate is larger than the rate alarm upper limit value, or if it is smaller than the rate alarm lower limit value.

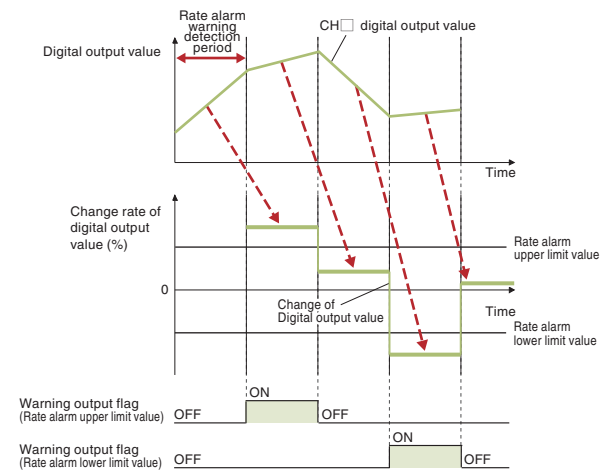

**Noise isolation for smoother system operation**

L60AD4-2GH

**Channel isolation**

Each channel is isolated preventing any noise interference between channels resulting in more stable measurements.

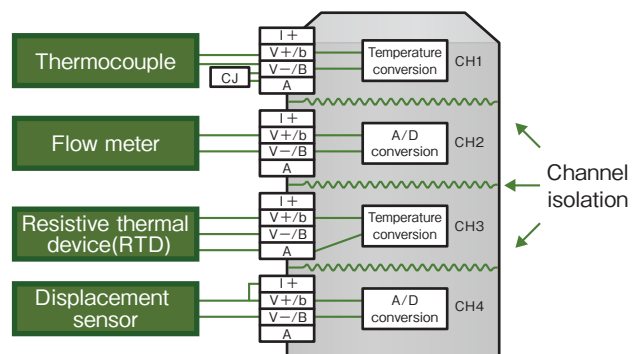

## A/D variable conversion timing

### Trigger conversion function

A/D conversion is processed at the rising edge of the trigger position timing.

This function enables easier use of the converter and enhances the overall program performance.

There are two types of trigger conversion request: “External trigger conversion request (external input terminal)” or “internal trigger conversion request (buffer memory)”.

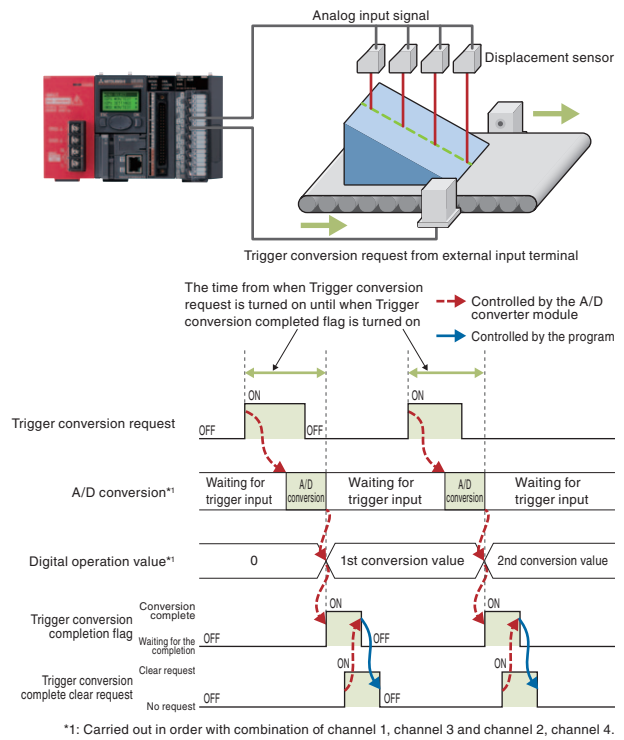

## Quickly calculate and record flow amount

### Flow amount integration function

This function performs the A/D conversion of analog input value (voltage or current) from a flow meter and others, and integrates the scaling value (digital operation value) by every integration cycle. In this function, integral processing is performed regarding the scaling value (digital operation value) as the instantaneous flow amount.

#### ■ Concept of integral processing

With this function, integral processing is performed using the following formula.

$$\text{Integrated flow amount} = \left( \text{Instantaneous flow amount} \times \frac{\Delta T}{T} \times \text{Unit scaling} \right) + \text{Previous amount}$$

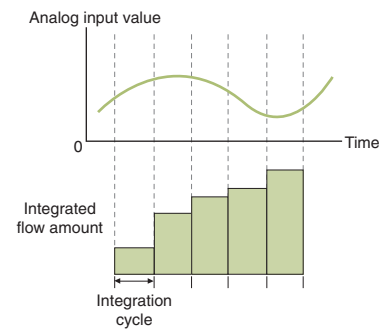

Item	Description												
Integrated flow amount	Result of integral processing												
Instantaneous flow amount	Instantaneous flow amount value output in analog from flow meter												
$\Delta T$	Integration cycle (ms)												
T	Conversion value to convert time unit of instantaneous flow amount to ms unit												
	<table border="1"> <thead> <tr> <th>Range of flow meter</th> <th>Setting value to specify flow amount time unit</th> <th>T (ms)</th> </tr> </thead> <tbody> <tr> <td>/s</td> <td>0</td> <td>1000</td> </tr> <tr> <td>/min</td> <td>1</td> <td>60000</td> </tr> <tr> <td>/h</td> <td>2</td> <td>3600000</td> </tr> </tbody> </table>	Range of flow meter	Setting value to specify flow amount time unit	T (ms)	/s	0	1000	/min	1	60000	/h	2	3600000
	Range of flow meter	Setting value to specify flow amount time unit	T (ms)										
	/s	0	1000										
/min	1	60000											
/h	2	3600000											
Unit scaling for integrated flow amount													
Unit scaling	This is used when the value of instantaneous flow amount $\times \Delta T/T$ is 0 to 1.												
	<table border="1"> <thead> <tr> <th>Setting value to specify unit scaling</th> <th>Unit scaling</th> </tr> </thead> <tbody> <tr> <td>0</td> <td>1</td> </tr> <tr> <td>1</td> <td>10</td> </tr> <tr> <td>2</td> <td>100</td> </tr> <tr> <td>3</td> <td>1000</td> </tr> <tr> <td>4</td> <td>10000</td> </tr> </tbody> </table>	Setting value to specify unit scaling	Unit scaling	0	1	1	10	2	100	3	1000	4	10000
	Setting value to specify unit scaling	Unit scaling											
	0	1											
	1	10											
2	100												
3	1000												
4	10000												
Previous amount	Stored integrated flow amount value before integral processing												

Realize fast and smooth continuous analog output

Wave output function

The industry's first\*1 waveform output function is included.

This function enables control wave data that is faster than the program control to be directly registered in the D/A converter module and output the data at a set conversion cycle.

Therefore, the analog output value is not affected by the scan time of the CPU module resulting in faster and smoother analog control.

\*1: Mitsubishi Electric survey dated April 2012.

Analog output from sequence program

Analog values are output at each scan time.

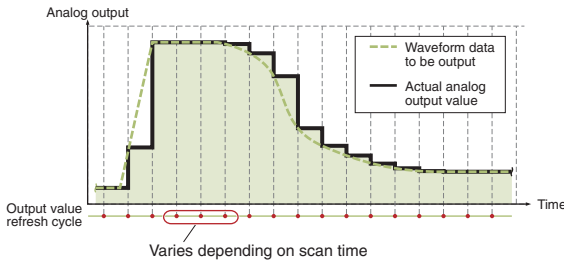

The actual waveform and the output waveform deviate.



Analog output with waveform output function

Analog values are output at set interval.

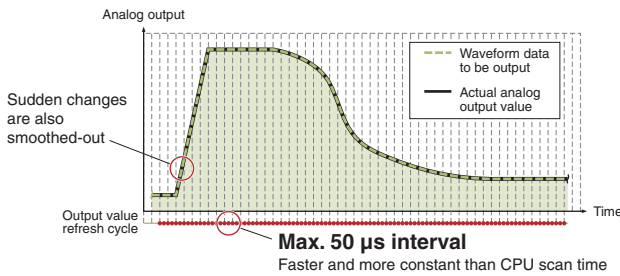

The output waveform is closer to the actual waveform (less deviation).

Register up to 50000 points of waveform output data

① Using GX Works2 to create the waveform output data to be analog output

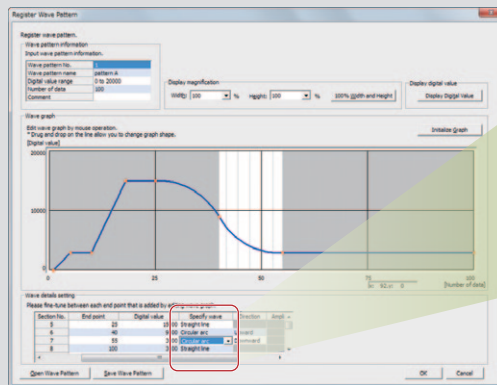

By registering the waveform patterns (multiple), they can be combined freely with the tool.

② Save waveform output data into CPU module's file resistor (or SD memory card)

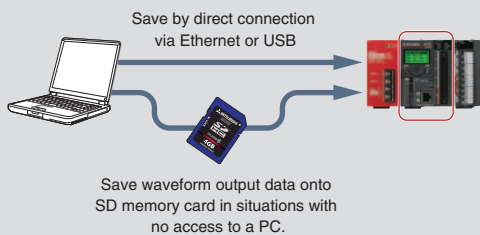

③ Execute the function block (FB)\*2 and register into analog output module

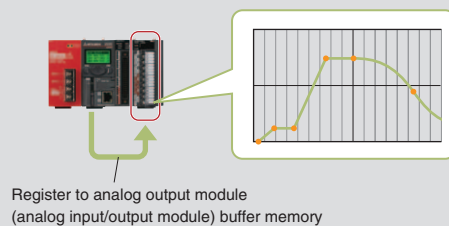

\*2: Contact your local Mitsubishi Electric sales office or representative.



## Easily adjust waveform output data

### Wave output step action function

The waveform output data can be changed even when the analog output module is in conversion. This provides a good way of adjusting the waveform output while in operation.

### Analog output a designated buffer memory's address value

If current address is "14990" (A) the output range is set to -10V to 10V range and receives "waveform output step execution request", the address 15000 (B) and address 14995 (C) data is executed.

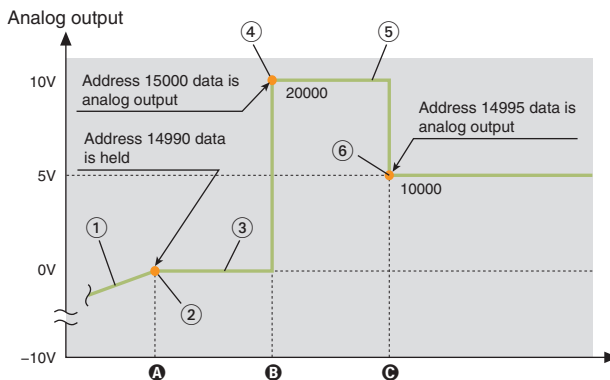
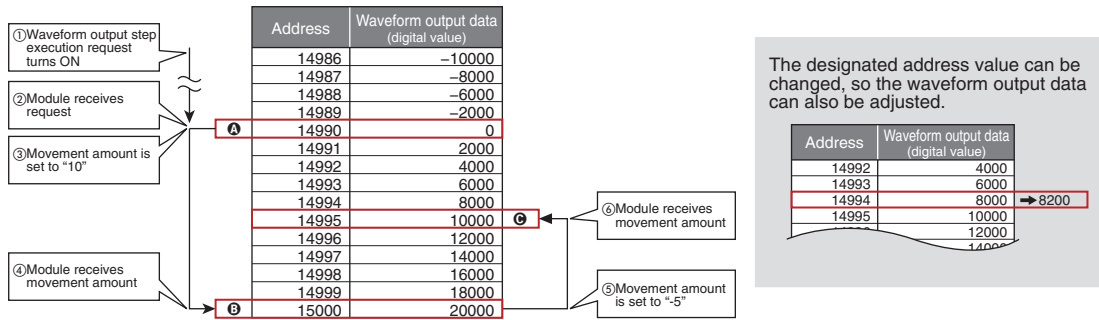

Address can be moved to data to be output and the output value can be output

## One module covering voltage, current, micro-voltage, thermocouples and RTD

For each channel, it is possible to select from voltage, current, micro-voltage, thermocouples or RTD. As a result, dedicated modules required for each type of sensor can now be integrated into a single module.

**Example** System with up to four channels (including analog and temperature input channels)

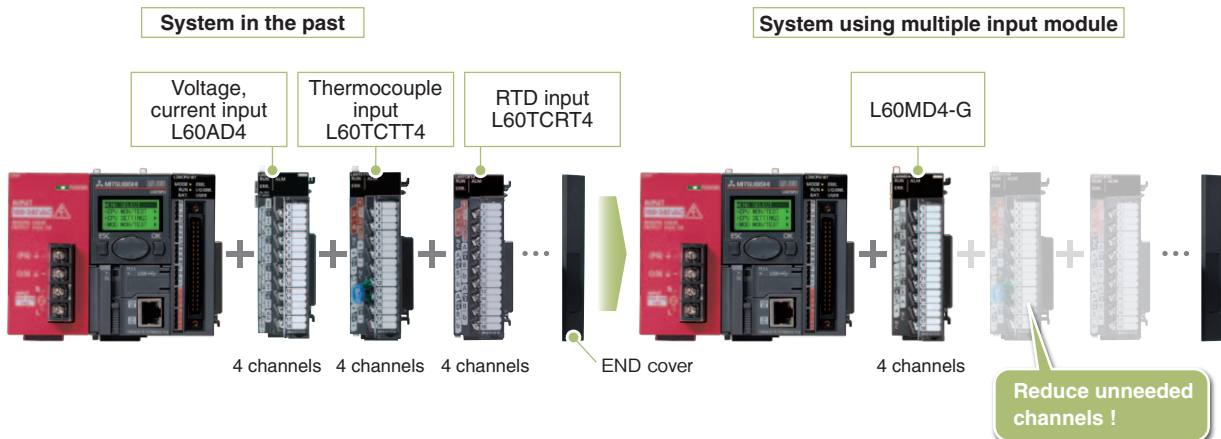

The multiple input module also supports the Pt50 and JPt100 sensors, which are compatible with the former JIS standards. Modules can be replaced without altering the already existing sensor equipment.

Thermocouple	K, J, T, E, N, R, S, B, U, L, PL II, W5Re/W26Re
Resistive thermal device	Pt1000, Pt100, JPt100, Pt50

## Multiple input (voltage/current/temperature) module specifications

Item		L60MD4-G <b>NEW</b>																																										
Number of analog input channels		4 channels																																										
Analog input	Voltage	-10...10 V DC (Input resistance value 1 MΩ)																																										
	Current	0...20 mA DC (Input resistance value 250 Ω)																																										
	micro voltage	-100...100 mV DC																																										
	Thermocouple	Available type	K, J, T, E, N, R, S, B, U, L, PL II, W5Re/W26Re																																									
		Cold junction compensation resistor	Use the included cold junction compensation resistor (CJ)																																									
Resistive thermal device	Available type	Pt1000, Pt100, JPt100, Pt50																																										
	Measurement method	3-wire system																																										
Digital output	Voltage, Current, micro voltage	-20480...20479																																										
	Resistive thermal device Pt100 (-20...120°C), JPt100 (-20...120°C)	-2000...20000: Value rounded off to two decimal places × 100 times																																										
	Thermocouple, Resistive thermal device (other than the above)	-4000...32000: Value rounded off to one decimal place × 10 times																																										
	When using the scaling function	-32768...32767																																										
I/O characteristics, resolution	<table border="1"> <thead> <tr> <th></th> <th>Analog input range</th> <th>Digital output value</th> <th>Resolution</th> </tr> </thead> <tbody> <tr> <td rowspan="5">Voltage</td> <td>0...10 V</td> <td>0...20000</td> <td>500 μV</td> </tr> <tr> <td>0...5 V</td> <td>0...20000</td> <td>250 μV</td> </tr> <tr> <td>1...5 V</td> <td>0...20000</td> <td>200 μV</td> </tr> <tr> <td>-10...10 V</td> <td>-20000...20000</td> <td>500 μV</td> </tr> <tr> <td>1...5 V (Extended mode)</td> <td>-5000...22500</td> <td>200 μV</td> </tr> <tr> <td rowspan="3">Current</td> <td>0...20 mA</td> <td rowspan="2">0...20000</td> <td>1000 nA</td> </tr> <tr> <td>4...20 mA</td> <td>800 nA</td> </tr> <tr> <td>4...20 mA (Extended mode)</td> <td>-5000...22500</td> <td>800 nA</td> </tr> <tr> <td>micro voltage</td> <td>-100...100 mV</td> <td>-20000...20000</td> <td>5 μV</td> </tr> <tr> <td>Thermocouple</td> <td colspan="3">B, R, S, N, PL II, W5Re/W26Re: 0.3°C K, E, J, T, U, L: 0.1°C</td> </tr> <tr> <td>Resistive thermal device (RTD)</td> <td colspan="3">Pt100 (-20...120°C), JPt100 (-20...120°C): 0.03°C Pt100 (-200...850°C), JPt100 (-200...600°C), Pt1000, Pt50: 0.1°C</td> </tr> </tbody> </table>				Analog input range	Digital output value	Resolution	Voltage	0...10 V	0...20000	500 μV	0...5 V	0...20000	250 μV	1...5 V	0...20000	200 μV	-10...10 V	-20000...20000	500 μV	1...5 V (Extended mode)	-5000...22500	200 μV	Current	0...20 mA	0...20000	1000 nA	4...20 mA	800 nA	4...20 mA (Extended mode)	-5000...22500	800 nA	micro voltage	-100...100 mV	-20000...20000	5 μV	Thermocouple	B, R, S, N, PL II, W5Re/W26Re: 0.3°C K, E, J, T, U, L: 0.1°C			Resistive thermal device (RTD)	Pt100 (-20...120°C), JPt100 (-20...120°C): 0.03°C Pt100 (-200...850°C), JPt100 (-200...600°C), Pt1000, Pt50: 0.1°C		
		Analog input range	Digital output value	Resolution																																								
	Voltage	0...10 V	0...20000	500 μV																																								
		0...5 V	0...20000	250 μV																																								
		1...5 V	0...20000	200 μV																																								
		-10...10 V	-20000...20000	500 μV																																								
		1...5 V (Extended mode)	-5000...22500	200 μV																																								
	Current	0...20 mA	0...20000	1000 nA																																								
		4...20 mA		800 nA																																								
		4...20 mA (Extended mode)	-5000...22500	800 nA																																								
micro voltage	-100...100 mV	-20000...20000	5 μV																																									
Thermocouple	B, R, S, N, PL II, W5Re/W26Re: 0.3°C K, E, J, T, U, L: 0.1°C																																											
Resistive thermal device (RTD)	Pt100 (-20...120°C), JPt100 (-20...120°C): 0.03°C Pt100 (-200...850°C), JPt100 (-200...600°C), Pt1000, Pt50: 0.1°C																																											
Accuracy <sup>1,2</sup>	Voltage/Current/ micro voltage	Ambient temperature 25 ± 5°C	Maximum value of the measurement range (± 0.3%)																																									
		Ambient temperature 0...55°C	Maximum value of the measurement range (± 0.9%)																																									
	Thermocouple	Ambient temperature 25 ± 5°C	Full scale (± 0.15%)																																									
		Ambient temperature 0...55°C	Full scale (± 0.3%) <sup>3</sup>																																									
	Cold junction compensation resistor <sup>4</sup>	Temperature measured value: -100°C or higher	≤ ± 1.0°C																																									
		Temperature measured value: -150°C...-100°C	≤ ± 2.0°C																																									
Temperature measured value: -200°C...-150°C		≤ ± 3.0°C																																										
Resistive thermal device	(Accuracy) <sup>5</sup> = (Conversion accuracy) + (Temperature characteristics) × (Operating ambient temperature change) + (Allowable difference of resistance temperature detector used)																																											
Conversion speed	50 ms/ch																																											
Output current for temperature detection	Pt100, JPt100, Pt50: 1 mA, Pt1000: 0.2 mA																																											
Absolute maximum input	Voltage: ±15 V, Current: 30 mA <sup>6</sup>																																											
Isolation method	Between I/O terminals and programmable controller power supply: photocoupler isolation Between input channels: transformer isolation																																											
Number of occupied I/O points	16 points (I/O assignment: 16 points for intelligent)																																											
External interface	18-point terminal block																																											
5 V DC internal current consumption	0.49 A																																											
Weight	0.19 kg																																											

\*1: Except when influenced by noise.

\*2: To acquire sufficient accuracy, a warm-up (conduction) for 15 minutes is required.

\*3: The accuracy for when the measured temperature of the type W5Re/W26Re thermocouple is 2000°C or higher is ±0.5%.

\*4: The following table shows the accuracy of the cold junction compensation for when the type "T" thermocouple or type "U" thermocouple is used.

Measured temperature	T Thermocouple	U Thermocouple
0°C or higher	± 1.0°C	
-100°C...0°C	± 2.0°C	
-150°C...-100°C	± 3.0°C	
-200°C...-150°C	± 5.0°C	± 4.0°C

\*5: The following table shows RTD types and values for each item.

RTD type	Celsius			Fahrenheit		
	Measured temperature range	Conversion accuracy (operating ambient temperature: 25±5°C)	Temperature characteristics (for a change of 1°C in the operating ambient temperature)	Measured temperature range	Conversion accuracy (operating ambient temperature: 25±5°C)	Temperature characteristics (for a change of 1°C in the operating ambient temperature)
Pt100	-20...-120°C	1°C	0.1°C	0...200°F	1°F	0.1°F
	-200...850°C	2°C	0.2°C	-300...1500°F	3°F	0.3°F
JPt100	-20...-120°C	1°C	0.1°C	0...200°F	1°F	0.1°F
	-200...600°C	2°C	0.2°C	-300...1100°F	3°F	0.3°F
Pt1000	-200...850°C	2°C	0.2°C	-300...1500°F	3°F	0.3°F
Pt50	-200...650°C	2°C	0.2°C	-300...1200°F	3°F	0.2°F

• Allowable difference of Pt100 (JIS C 1604-1997, IEC 751 1983)

Class	Allowable difference
A	± (0.15 + 0.002 Itl)°C
B	± (0.3 + 0.005 Itl)°C

• Allowable difference of Pt100, allowable difference of Pt50 (JIS C 1604-1981)

Class	Allowable difference
0.15	± (0.15 + 0.0015 Itl)°C
0.2	± (0.15 + 0.002 Itl)°C
0.5	± (0.3 + 0.005 Itl)°C

The allowable difference of Pt1000 is not provided in the JIS standard, and therefore is not described here. Please contact your Mitsubishi Electric or local sales representative for further details.

\*6: A momentary current value which does not cause damage to internal resistors of the module, although the maximum continuous input current is 24 mA.

■ Analog input module specifications

L60AD4

Item		L60AD4																																		
Number of analog input channels		4 channels																																		
Analog input	Voltage	-10...10 V DC (Input resistance value 1 MΩ)																																		
	Current	0...20 mA DC (Input resistance value 250 Ω)																																		
Digital output		-20480...20479																																		
	When using the scaling function	-32768...32767																																		
I/O characteristics, resolution	<table border="1"> <thead> <tr> <th>Analog input range</th> <th>Digital output value</th> <th>Resolution</th> </tr> </thead> <tbody> <tr> <td rowspan="5">Voltage</td> <td>0...10 V</td> <td rowspan="3">0...20000</td> <td>500 μV</td> </tr> <tr> <td>0...5 V</td> <td>250 μV</td> </tr> <tr> <td>1...5 V</td> <td>200 μV</td> </tr> <tr> <td>-10...10 V</td> <td>-20000...20000</td> <td>500 μV</td> </tr> <tr> <td>1...5 V (Extended mode)</td> <td>-5000...22500</td> <td>200 μV</td> </tr> <tr> <td></td> <td>Users range setting</td> <td>-20000...20000</td> <td>307 μV<sup>*1</sup></td> </tr> <tr> <td rowspan="5">Current</td> <td>0...20 mA</td> <td rowspan="2">0...20000</td> <td>1000 nA</td> </tr> <tr> <td>4...20 mA</td> <td>800 nA</td> </tr> <tr> <td>4...20 mA (Extended mode)</td> <td>-5000...22500</td> <td>800 nA</td> </tr> <tr> <td></td> <td>Users range setting</td> <td>-20000...20000</td> <td>1230 nA<sup>*1</sup></td> </tr> </tbody> </table>		Analog input range	Digital output value	Resolution	Voltage	0...10 V	0...20000	500 μV	0...5 V	250 μV	1...5 V	200 μV	-10...10 V	-20000...20000	500 μV	1...5 V (Extended mode)	-5000...22500	200 μV		Users range setting	-20000...20000	307 μV <sup>*1</sup>	Current	0...20 mA	0...20000	1000 nA	4...20 mA	800 nA	4...20 mA (Extended mode)	-5000...22500	800 nA		Users range setting	-20000...20000	1230 nA <sup>*1</sup>
	Analog input range	Digital output value	Resolution																																	
	Voltage	0...10 V	0...20000	500 μV																																
		0...5 V		250 μV																																
		1...5 V		200 μV																																
		-10...10 V	-20000...20000	500 μV																																
		1...5 V (Extended mode)	-5000...22500	200 μV																																
		Users range setting	-20000...20000	307 μV <sup>*1</sup>																																
	Current	0...20 mA	0...20000	1000 nA																																
		4...20 mA		800 nA																																
4...20 mA (Extended mode)		-5000...22500	800 nA																																	
		Users range setting	-20000...20000	1230 nA <sup>*1</sup>																																
Accuracy <sup>*2</sup>		Ambient temperature 25 ± 5°C	≤ ± 0.1% (± 20 digit)																																	
	Ambient temperature 0...55°C	≤ ± 0.2% (± 40 digit)																																		
Conversion speed <sup>*3,4,5</sup>		High speed: 20 μs/channel Medium speed: 80 μs/channel Low speed: 1 ms/channel																																		
Absolute maximum input		Voltage: ± 15 V, Current: 30 mA <sup>*6</sup>																																		
Isolation method		Between I/O terminals and programmable controller power supply: photocoupler isolation Between input channels: no isolation																																		
Maximum number of modules specification		Counts as 1 module																																		
Number of occupied I/O points		16 points (I/O assignment: 16 points for intelligent)																																		
External interface		18-point terminal block																																		
5 V DC internal current consumption		0.52 A																																		
Weight		0.19 kg																																		

L60ADVL8

Item		L60ADVL8 <b>NEW</b>																					
Number of analog input channels		8 channels																					
Analog input	Voltage	-10...10 V DC (Input resistance value 1 MΩ)																					
	Current	0...20 mA DC (Input resistance value 250 Ω)																					
Digital output		-16384...16383																					
	When using the scaling function	-32768...32767																					
I/O characteristics, resolution	<table border="1"> <thead> <tr> <th>Analog input range</th> <th>Digital output value</th> <th>Resolution</th> </tr> </thead> <tbody> <tr> <td rowspan="7">Voltage</td> <td>0...10 V</td> <td rowspan="3">0...16000</td> <td>625 μV</td> </tr> <tr> <td>0...5 V</td> <td>625 μV</td> </tr> <tr> <td>1...5 V</td> <td>500 μV</td> </tr> <tr> <td>-10...10 V</td> <td>-16000...16000</td> <td>625 μV</td> </tr> <tr> <td>1...5 V (Extended mode)</td> <td>-2000...9000</td> <td>500 μV</td> </tr> <tr> <td></td> <td>Users range setting</td> <td>-8000...8000</td> <td>414 μV<sup>*1</sup></td> </tr> </tbody> </table>		Analog input range	Digital output value	Resolution	Voltage	0...10 V	0...16000	625 μV	0...5 V	625 μV	1...5 V	500 μV	-10...10 V	-16000...16000	625 μV	1...5 V (Extended mode)	-2000...9000	500 μV		Users range setting	-8000...8000	414 μV <sup>*1</sup>
	Analog input range	Digital output value	Resolution																				
	Voltage	0...10 V	0...16000	625 μV																			
		0...5 V		625 μV																			
		1...5 V		500 μV																			
		-10...10 V	-16000...16000	625 μV																			
		1...5 V (Extended mode)	-2000...9000	500 μV																			
		Users range setting	-8000...8000	414 μV <sup>*1</sup>																			
Accuracy <sup>*2</sup>		Ambient temperature 25 ± 5°C	≤ ± 0.2%																				
	Ambient temperature 0...55°C	≤ ± 1%																					
Conversion speed <sup>*3,4,5</sup>		1 ms/ch																					
Absolute maximum input		Voltage ± 15 V																					
Isolation method		Between I/O terminals and programmable controller power supply: photocoupler isolation Between input channels: no isolation																					
Maximum number of modules specification		1																					
Number of occupied I/O points		16 points (I/O assignment: 16 points for intelligent)																					
External interface		18-point terminal block																					
5 V DC internal current consumption		0.20 A																					
Weight		0.19 kg																					

L60ADIL8

Item		L60ADIL8 <b>NEW</b>																
Number of analog input channels		8 channels																
Analog input	Current	0...20 mA DC (Input resistance value 250 Ω)																
	Digital output	-8192...8192																
	When using the scaling function	-32768...32767																
I/O characteristics, resolution	<table border="1"> <thead> <tr> <th>Analog input range</th> <th>Digital output value</th> <th>Resolution</th> </tr> </thead> <tbody> <tr> <td rowspan="5">Current</td> <td>0...20 mA</td> <td rowspan="2">0...8000</td> <td>2500 nA</td> </tr> <tr> <td>4...20 mA</td> <td>2000 nA</td> </tr> <tr> <td>4...20 mA (Extended mode)</td> <td>-2000...9000</td> <td>2000 nA</td> </tr> <tr> <td></td> <td>Users range setting</td> <td>-8000...8000</td> <td>1660 nA<sup>*1</sup></td> </tr> </tbody> </table>		Analog input range	Digital output value	Resolution	Current	0...20 mA	0...8000	2500 nA	4...20 mA	2000 nA	4...20 mA (Extended mode)	-2000...9000	2000 nA		Users range setting	-8000...8000	1660 nA <sup>*1</sup>
	Analog input range	Digital output value	Resolution															
	Current	0...20 mA	0...8000	2500 nA														
		4...20 mA		2000 nA														
		4...20 mA (Extended mode)	-2000...9000	2000 nA														
		Users range setting	-8000...8000	1660 nA <sup>*1</sup>														
Accuracy <sup>*2</sup>		Ambient temperature 25 ± 5°C	≤ ± 0.2%															
	Ambient temperature 0...55°C	≤ ± 1%																
Conversion speed <sup>*3,4,5</sup>		1 ms/ch																
Absolute maximum input		Current 30 mA <sup>*6</sup>																
Isolation method		Between I/O terminals and programmable controller power supply: photocoupler isolation Between input channels: no isolation																
Maximum number of modules specification		1																
Number of occupied I/O points		16 points (I/O assignment: 16 points for intelligent)																
External interface		18-point terminal block																
5 V DC internal current consumption		0.21 A																
Weight		0.19 kg																

\*1: Maximum resolution in the user range setting.

\*2: Accuracy for the maximum value of the digital output value. Except when influenced by noise.

\*3: The default value is 80 μs/channel.

\*4: The logging function can be used only in the middle speed (80 μs/channel) or low speed (1 ms/channel).

\*5: The flow amount integration function can be used only in the low speed (1 ms/channel).

\*6: A momentary current value which does not cause damage to internal resistors of the module, although the maximum continuous input current is 24 mA.

## Dual channel isolation analog input module specifications

Item		L60AD4-2GH																																		
Number of analog input channels		4 channels																																		
Analog input	Voltage	-10...10 V DC (Input resistance value 1 MΩ)																																		
	Current	0...20 mA DC (Input resistance value 250 Ω)																																		
Digital output		-32000...32000																																		
	When using the scaling function	-32768...32767																																		
I/O characteristics, resolution	<table border="1"> <thead> <tr> <th></th> <th>Analog input range</th> <th>Digital output value</th> <th>Resolution</th> </tr> </thead> <tbody> <tr> <td rowspan="5">Voltage</td> <td>0...10 V</td> <td rowspan="3">0...32000</td> <td>312.5 μV</td> </tr> <tr> <td>0...5 V</td> <td>156 μV</td> </tr> <tr> <td>1...5 V</td> <td>125 μV</td> </tr> <tr> <td>-10...10 V</td> <td>-32000...32000</td> <td>312.5 μV</td> </tr> <tr> <td>1...5 V (Extended mode)</td> <td>-8000...32000</td> <td>125 μV</td> </tr> <tr> <td>Users range setting (Bipolar: voltage)</td> <td>-32000...32000</td> <td>200 μV*1</td> </tr> <tr> <td rowspan="5">Current</td> <td>0...20 mA</td> <td rowspan="2">0...32000</td> <td>625 nA</td> </tr> <tr> <td>4...20 mA</td> <td>500 nA</td> </tr> <tr> <td>4...20 mA (Extended mode)</td> <td>-8000...32000</td> <td>500 nA</td> </tr> <tr> <td>Users range setting (Unipolar: Current)</td> <td>0...32000</td> <td>400 nA*1</td> </tr> </tbody> </table>				Analog input range	Digital output value	Resolution	Voltage	0...10 V	0...32000	312.5 μV	0...5 V	156 μV	1...5 V	125 μV	-10...10 V	-32000...32000	312.5 μV	1...5 V (Extended mode)	-8000...32000	125 μV	Users range setting (Bipolar: voltage)	-32000...32000	200 μV*1	Current	0...20 mA	0...32000	625 nA	4...20 mA	500 nA	4...20 mA (Extended mode)	-8000...32000	500 nA	Users range setting (Unipolar: Current)	0...32000	400 nA*1
		Analog input range	Digital output value	Resolution																																
	Voltage	0...10 V	0...32000	312.5 μV																																
		0...5 V		156 μV																																
		1...5 V		125 μV																																
		-10...10 V	-32000...32000	312.5 μV																																
		1...5 V (Extended mode)	-8000...32000	125 μV																																
	Users range setting (Bipolar: voltage)	-32000...32000	200 μV*1																																	
	Current	0...20 mA	0...32000	625 nA																																
		4...20 mA		500 nA																																
4...20 mA (Extended mode)		-8000...32000	500 nA																																	
Users range setting (Unipolar: Current)		0...32000	400 nA*1																																	
Accuracy*2		Reference accuracy*3	≤ ± 0.05% (± 16 digit)																																	
	Temperature coefficient*4	≤ ± 40.1 ppm/°C																																		
Conversion speed		40 μs/2 channel																																		
Absolute maximum input		Voltage: ± 15 V, Current: 30 mA*5																																		
Isolation method		Between I/O terminals and programmable controller power supply: photocoupler isolation Between analog input channels: dual channel transformer isolation																																		
Maximum number of modules specification		Counts as 1 module																																		
Number of occupied I/O points		16 points (I/O assignment: 16 points for intelligent)																																		
External interface		18-point terminal block																																		
5 V DC internal current consumption		0.76 A																																		
Weight		0.20 kg																																		
External trigger input	Input points		1 point																																	
	Rated input voltage		24 V DC (+ 20%/-15%, ripple ratio: ≤ 5%)																																	
	Rated input current		6.0 mA TYP. (at 24 V DC)																																	
	ON voltage/ON current		≥ 13 V, ≥ 3 mA																																	
	OFF voltage/OFF current		≤ 8 V, ≤ 1.6 mA																																	
	Input resistance		3.9 kΩ																																	
	Response time	OFF to ON	40 μs																																	
	ON to OFF	40 μs																																		

\*1: Maximum resolution in the user range setting.

\*2: Accuracy for the maximum value of the digital output value. Except when influenced by noise.

\*3: Accuracy under the ambient temperature when the offset/gain setting is performed.

\*4: Accuracy when the temperature changes 1°C.

Example: Accuracy when the temperature changes from 25°C to 30°C

$$0.05\% + 0.00401\%/^{\circ}\text{C} (\text{temperature coefficient}) \times 5^{\circ}\text{C} (\text{temperature change}) = 0.070\%$$

\*5: A momentary input current value which does not cause damage to internal resistors of the module. The maximum input current value for constant application is 24 mA.

## Analog output module specifications

Item		L60DA4																									
Number of analog output channels		4 channels																									
Digital input		-20480...20479																									
	When using the scaling function	-32768...32767																									
Analog output	Voltage	-10...10 V DC (External load resistance value 1 kΩ...1 MΩ)																									
	Current	0...20 mA DC (External load resistance value 0 Ω...600 Ω)																									
I/O characteristics, resolution	<table border="1"> <thead> <tr> <th></th> <th>Analog output range</th> <th>Digital value</th> <th>Resolution</th> </tr> </thead> <tbody> <tr> <td rowspan="4">Voltage</td> <td>0...5 V</td> <td rowspan="2">0...20000</td> <td>250 μV</td> </tr> <tr> <td>1...5 V</td> <td>200 μV</td> </tr> <tr> <td>-10...10 V</td> <td rowspan="2">-20000...20000</td> <td>500 μV</td> </tr> <tr> <td>Users range setting</td> <td>333 μV*6</td> </tr> <tr> <td rowspan="3">Current</td> <td>0...20 mA</td> <td rowspan="2">0...20000</td> <td>1000 nA</td> </tr> <tr> <td>4...20 mA</td> <td>800 nA</td> </tr> <tr> <td>Users range setting</td> <td>-20000...20000</td> <td>700 nA*6</td> </tr> </tbody> </table>				Analog output range	Digital value	Resolution	Voltage	0...5 V	0...20000	250 μV	1...5 V	200 μV	-10...10 V	-20000...20000	500 μV	Users range setting	333 μV*6	Current	0...20 mA	0...20000	1000 nA	4...20 mA	800 nA	Users range setting	-20000...20000	700 nA*6
		Analog output range	Digital value	Resolution																							
	Voltage	0...5 V	0...20000	250 μV																							
		1...5 V		200 μV																							
		-10...10 V	-20000...20000	500 μV																							
		Users range setting		333 μV*6																							
	Current	0...20 mA	0...20000	1000 nA																							
4...20 mA		800 nA																									
Users range setting		-20000...20000	700 nA*6																								
Accuracy*7	Ambient temperature 25 ± 5°C	≤ ± 0.1%																									
	Ambient temperature 0...55°C	≤ ± 0.3%																									
Conversion speed	Normal output mode	20 μs/channel																									
	Wave output mode	50 μs/channel 80 μs/channel																									
Output short protection		Protected																									
Isolation method		Between I/O terminals and programmable controller power supply: photocoupler isolation Between output channels: no isolation Between external power supply and analog output: transformer isolation																									
Maximum number of modules specification		Counts as 1 module																									
Number of occupied I/O points		16 points (I/O assignment: 16 points for intelligent)																									
External interface		18-point terminal block																									
External power supply		24 V DC (+ 20%/-15%)																									
		Ripple, spike 500 mV <sub>r,p</sub> or lower																									
		Inrush current: 4.3 A, 1000 μs or shorter Current consumption: 0.18 A																									
5 V DC internal current consumption		0.16 A																									
Weight		0.20 kg																									

\*6: Maximum resolution in the user range setting.

\*7: Accuracy for the maximum value of analog output value. Except when influenced by noise. Warm up (power on) the module for 30 minutes to satisfy the accuracy shown in the table.

■ Analog input/output module specifications

Item		L60AD2DA2				
■ A/D conversion part						
Number of analog input channels		2 channels				
Analog input	Voltage	-10...10 V DC (Input resistance value 1 MΩ)				
	Current	0...20 mA DC (Input resistance value 250 Ω)				
Digital output		-16384...16383				
	When using the scaling function	-32768...32767				
I/O characteristics, resolution	Voltage	Analog input range		Digital output value	Resolution	
		0...10 V	0...16000		625 μV	
		0...5 V	0...12000		416 μV	
		1...5 V			333 μV	
		-10...10 V	-16000...16000		625 μV	
		1...5 V (Extended mode)	-3000...13500		333 μV	
	Users range setting		-12000...12000		321 μV*1	
	Current	0...20 mA	0...12000		1666 nA	
		4...20 mA			1333 nA	
		4...20 mA (Extended mode)	-3000...13500		1333 nA	
		Users range setting		-12000...12000		1287 nA*1
		Analog input range		Ambient temperature		
		25 ± 5°C		0...55°C		
Accuracy*2	Voltage	0...10 V	≤ ± 0.2%		≤ ± 0.3%	
		-10...10 V				
		0...5 V				
	Current	1...5 V (Extended mode)	≤ ± 0.2%		≤ ± 0.3%	
		0...20 mA				
		4...20 mA (Extended mode)				
Conversion speed		80 μs/channel				
Absolute maximum input		Voltage: ± 15 V, Current: 30 mA*3				
■ D/A conversion part						
Number of analog output channels		2 channels				
Digital input		-16384...16383				
	When using the scaling function	-32768...32767				
Analog output	Voltage	-10...10 V DC (External load resistance value 1k to 1M Ω)				
	Current	0...20 mA DC (External load resistance value 0 to 600 Ω)				
I/O characteristics, resolution	Voltage	Analog output range		Digital value	Resolution	
		0...5 V	0...12000		416 μV	
		1...5 V			333 μV	
		-10...10 V	-16000...16000		625 μV	
		Users range setting		-12000...12000		319 μV*1
		Current	0...20 mA	0...12000		1666 nA
	4...20 mA				1333 nA	
	Users range setting		-12000...12000		696 nA*1	
	Analog output range		Ambient temperature			
			25 ± 5°C		0...55°C	
	Accuracy*2		Voltage	0...5 V	≤ ± 0.2%	
		1...5 V				
-10...10 V		≤ ± 0.2%		≤ ± 0.4%		
Current		0...20 mA	≤ ± 0.2%		≤ ± 0.4%	
		4...20 mA				
Conversion speed	Normal output mode	80 μs/channel				
	Wave output mode					
Output short protection		Protected				
■ Common part						
Isolation method		Between I/O terminals and programmable controller power supply: photocoupler isolation Between output channels: no isolation Between external power supply and analog output: transformer isolation				
Maximum number of modules specification		Counts as 1 module				
Number of occupied I/O points		16 points (I/O assignment: 16 points for intelligent)				
External interface		18-point terminal block 24 V DC (+ 20%/−15%) Ripple, spike 500 mV <sub>P-P</sub> or lower Inrush current: 3.5 A, 1000 μs or shorter Current consumption: 0.12 A				
External power supply						
5 V DC internal current consumption		0.17 A				
Weight		0.22 kg				

\*1: Maximum resolution in the user range setting.

\*2: Accuracy for the maximum value of the digital/analog output value. Except when influenced by noise.

\*3: A momentary current value which does not cause damage to internal resistors of the module, although the maximum continuous input current 24 mA.

Temperature Control Modules

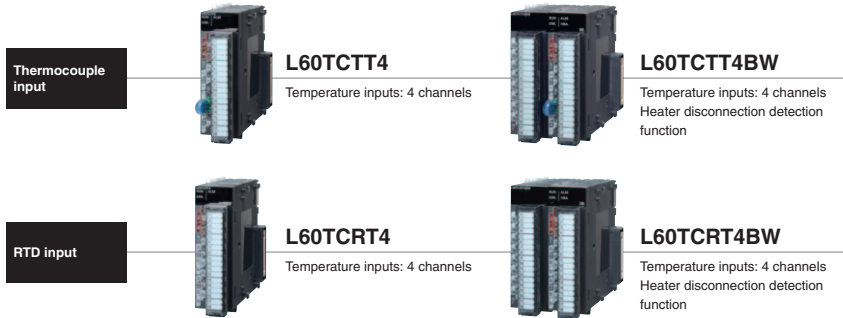

Function	L60TCTT4	L60TCTT4BW	L60TCRT4	L60TCRT4BW
	Thermocouple input		RTD input	
Standard control	●	●	●	●
Heating-cooling control	●	●	●	●
Self-tuning function	●	●	●	●
Peak current suppression function	●	●	●	●
Simultaneous temperature rise function	●	●	●	●
Selectable sampling cycle	●	●	●	●
Temperature input mode	●	●	●	●
Temperature control mode	●	●	●	●
Heater disconnection detection function	—	●	—	●

Highly stable temperature control

Standard control/heating and cooling control

Prevent overheating and overcooling in devices that require a high level of temperature stability, such as in an extrusion molding machine.

The following control methods can be selected according to the target device.

- Standard control (heating or cooling)
- Heating/cooling control (heating and cooling)
- Mix control (combination of standard control and heating-cooling control)

■ **Example: Standard control (heating only)**  
 The temperature of the object is controlled by adjusting the heater output based on the PID calculations resulting from the temperature sensor input.

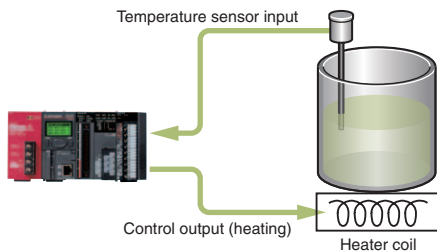

■ **Example: Heating-cooling control (heating and cooling elements controlled simultaneously)**  
 Heating is performed when the control object's temperature is lower than the target temperature, and cooling is performed when it is hotter or the humidity needs to be reduced.

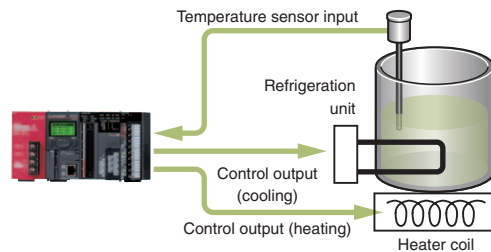

## Reduce running costs by taking advantage of the energy-saving effect

### Peak current control function

The peak current control function reduces the peak current by automatically changing the upper-output limit value for each channel, while dividing the transistor output timing\*1. The energy conserved by reducing the peak current, such as a reduction in system power capacity and reduction in contracted power, can help to reduce running costs.

\*1: The timing can be split between two to four outputs.

The maximum power supply capacity requirement is lowered.  
We can save money on our electricity contract!

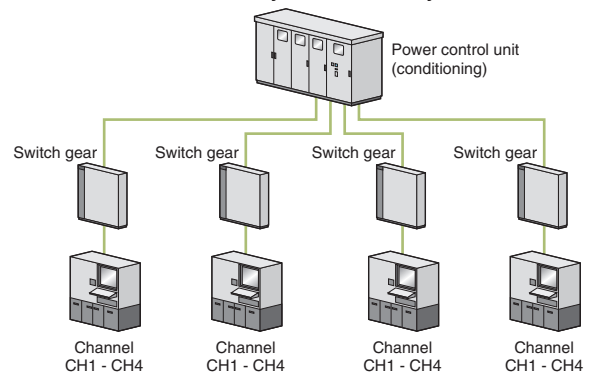

When two or more loads are being controlled, the peak current can be minimized by spreading the total load out over time.

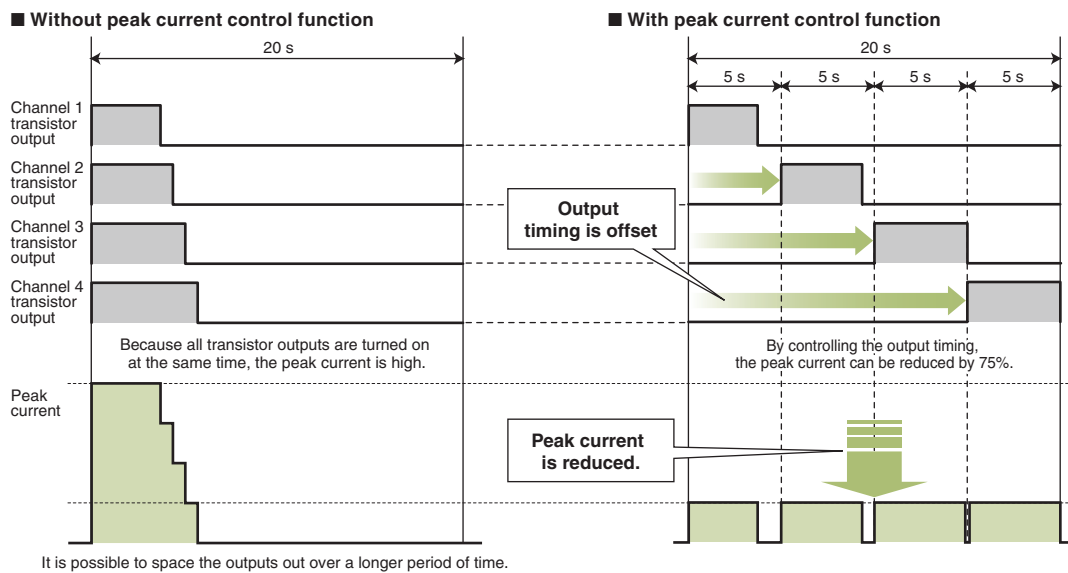

**Ensures uniform temperature control**

**Simultaneous temperature rise function**

Ensures uniform temperature control by synchronizing the temperature arrival times from multiple loops. Perform a uniform temperature rise using two or more control loops without going over temperature or resulting in unexpected thermal expansion.

A "no idling" format increases energy efficiency and reduces running costs.

■ **Example: Temperature control of injection molding machine**

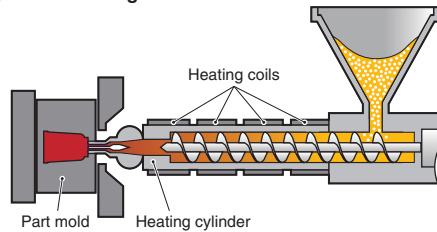

■ **Example: Wafer heating process for semiconductor manufacturing**

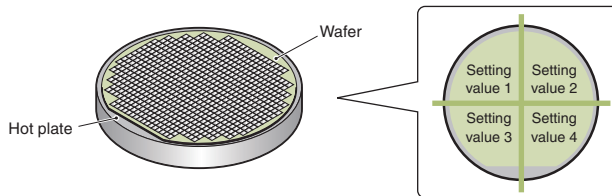

The running costs is reduced!

■ **Without the simultaneous temperature rise function**

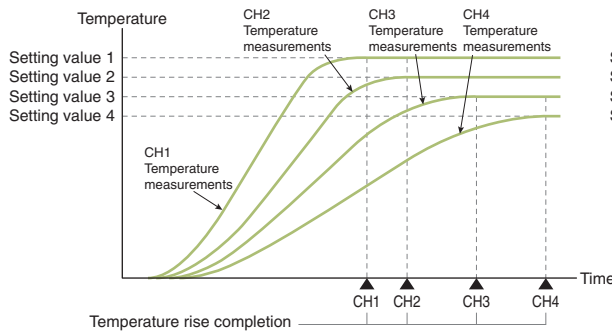

■ **With the simultaneous temperature rise function**

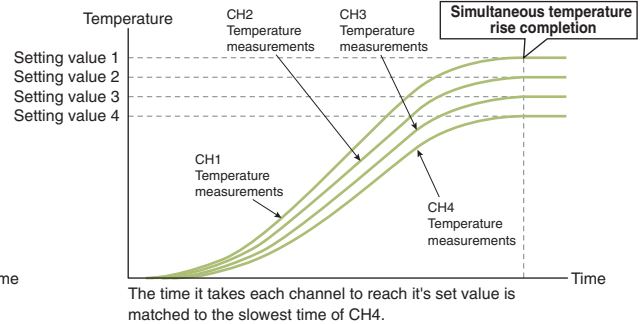

Using this function, it is possible to coordinate the control of two or more loops to reach their target values (SV) at the same time. Control the simultaneous rise in temperature of separate loops by setting a channel group (Max. 2 groups). This is an effective way to control applications where differing target temperature arrival times can result in undesirable temperature differentials.

**Support a range of system requirements**

**Sampling cycle change function**

Choose a sampling cycle of 250 ms/4 channels or 500 ms/4 channels.

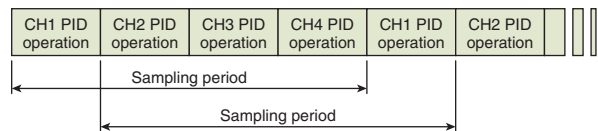

Sampling period: The time it takes to execute a PID operation for all channels (CHn) before beginning the PID operation of the present channel (CHn) again is called a sampling period.

**Temperature input mode**

This function allows the temperature control module to be used as a standard temperature input module.

Using the switch setting, it is possible to easily change the input mode.

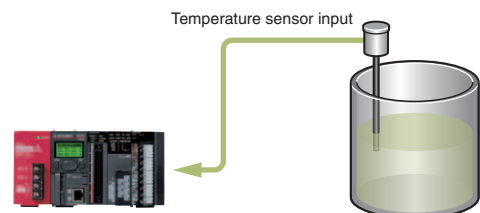



## Specifications

Item		L60TCTT4	L60TCTT4BW	L60TCRT4	L60TCRT4BW
Control output		Transistor output			
Number of temperature input channels		4 channels			
Applicable temperature sensors		Thermocouple		Resistive thermal device	
Accuracy*1	Indication accuracy	Ambient temperature: 25 ± 5°C		Full scale × (± 0.3%)	
		Ambient temperature: 0...55°C		Full scale × (± 0.7%)	
	Cold junction temperature compensation accuracy: (ambient temperature: 0...55°C)	Temperature process value (PV): -100°C or more		≤ ± 1.0°C	
		Temperature process value (PV): -150...-100°C		≤ ± 2.0°C	
		Temperature process value (PV): -200...-150°C		≤ ± 3.0°C	
Sampling cycle		250 ms/4 channels 500 ms/4 channels			
Control output cycle		0.5...100.0 s			
Input impedance		1 MΩ			
Input filter		0...100 s (0: Input filter OFF)			
Sensor correction value setting		-50.00...50.00%			
Operation at sensor input disconnection		Upscale processing			
Temperature control method		PID ON/OFF pulse or two-position control			
PID constants range	PID constants setting		Can be set by auto tuning.		
	Proportional band (P)		0.0...1000.0% (0: Two-position control)		
	Integral time (I)		0...3600 s (set 0 for P control and PD control.)		
	Derivative time (D)		0...3600 s (set 0 for P control and PI control.)		
Set value (SV) setting range		Within the temperature range set in the thermocouple/platinum resistance thermometer to be used			
Dead band setting range		0.1...10.0%			
Transistor output	Output signal		ON/OFF pulse		
	Rated load voltage		10...30 V DC		
	Max. load current		0.1 A/point, 0.4 A/common		
	Max. inrush current		0.4 A 10 ms		
	Leakage current at OFF		≤ 0.1 mA		
	Max. voltage drop at ON		1.0 V DC (TYP) at 0.1 A 2.5 V DC (MAX) at 0.1 A		
Response time		OFF→ON: ≤ 2 ms, ON→OFF: ≤ 2 ms			
Number of accesses to non-volatile memory		Max. 10 <sup>12</sup> times			
Isolation method		Between input terminal and programmable controller power supply: Transformer isolation Between input channels: Transformer isolation			
Heater disconnection detection specifications	Current sensor	—		—	
		• CTL-12-S36-10 (0.0...100.0 A)*2 • CTL-12-S56-10 (0.0...100.0 A)*2 • CTL-6-P-H (0.00...20.00 A)*2		• CTL-12-S36-10 (0.0...100.0 A)*2 • CTL-12-S56-10 (0.0...100.0 A)*2 • CTL-6-P-H (0.00...20.00 A)*2	
	Input accuracy	Full scale × (± 1.0%)		Full scale × (± 1.0%)	
Number of alert delay		3...255		3...255	
Maximum number of modules specification		Counts as 1 module	Counts as 2 modules	Counts as 1 module	Counts as 2 modules
Number of occupied I/O points		16 points (I/O assignment: Intelligent 16 points)			
External interface		18-point terminal block	18-point terminal block × 2	18-point terminal block	18-point terminal block × 2
5 V DC internal current consumption		0.30 A	0.33 A	0.31 A	0.35 A
Weight		0.18 kg	0.33 kg	0.18 kg	0.33 kg

\*1: Calculate the accuracy in the following method (only when it is not affected by noise).

Accuracy (°C) = full scale × indication accuracy + cold junction temperature compensation accuracy

Ex.) Accuracy at the input range of 38 (-200.0 to 400.0°C), the operating ambient temperature of 35°C, and the temperature process value (PV) of 300°C

(Full scale) × (indication accuracy) + cold junction temperature compensation accuracy

= (400.0°C - (-200.0°C)) × (±0.007) + (±1.0°C)

= ± 5.2°C

\*2: U.R.D.Co., LTD. For more information, visit <http://www.u-rd.com>

## Control mode

Control mode	Contents	Number of controllable loops
Standard control	Performs the standard control of four channels.	Standard control 4 loops
Heating-cooling control (normal mode)	Performs the heating-cooling control. CH3 and CH4 cannot be used.	Heating-cooling control 2 loops
Heating-cooling control (expanded mode)	Performs the heating-cooling control. The number of loops is expanded using an output module and others in the system.	Heating-cooling control 4 loops
Mix control (normal mode)	Performs the standard control and the heating-cooling control. CH2 cannot be used.	Standard control 2 loops Heating-cooling control 1 loop
Mix control (expanded mode)	Performs the standard control and the heating-cooling control. The number of loops is expanded using an output module and others in the system.	Standard control 2 loops Heating-cooling control 2 loops

Control for each channel is as follows.

Channel	Standard control	Heating-cooling control		Mix control	
		Normal mode	Expanded mode	Normal mode	Expanded mode
CH1	Standard control	Heating-cooling control	Heating-cooling control	Heating-cooling control	Heating-cooling control
CH2	Standard control	Heating-cooling control	Heating-cooling control	—*3	Heating-cooling control*4
CH3	Standard control	—*3	Heating-cooling control*4	Standard control	Standard control
CH4	Standard control	—*3	Heating-cooling control*4	Standard control	Standard control

\*3: Only temperature measurement using a temperature input terminal can be performed.

\*4: Heating-cooling control is performed using an output module in the system.

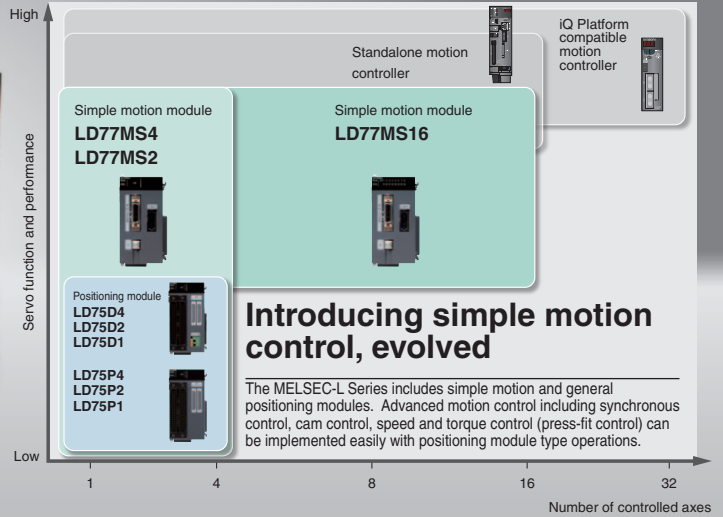

## Simple Motion Modules

SSCNET III/H-compatible



### LD77MS2

Number of control axes: 2 axes  
Communication cycle: 150 Mbps  
Positioning data: 600 data/axis  
Max. connection distance: 100 m



### LD77MS4

Number of control axes: 4 axes  
Communication cycle: 150 Mbps  
Positioning data: 600 data/axis  
Max. connection distance: 100 m



### LD77MS16

Number of control axes: 16 axes  
Communication cycle: 150 Mbps  
Positioning data: 600 data/axis  
Max. connection distance: 100 m



\*SSCNET (Servo System Controller NETWORK)

Function	LD77MS2	LD77MS4	LD77MS16
Positioning control function	●	●	●
Speed/torque control function	●	●	●
Linear interpolation	2 axes	2/3/4 axes	2/3/4 axes
Circular interpolation	2 axes	2 axes	2 axes
Synchronous control function	External encoder	●	●
	Cam	●	●
	Phase compensation	●	●
Manual pulse generator operation function	●	●	●
OPR control function	●	●	●

## Positioning Modules

Open collector output



### LD75P1

Number of control axes: 1 axis  
Max. output pulses: 200K pulses/s  
Positioning data: 600 data/axis  
Max. connection distance: 2 m



### LD75P2

Number of control axes: 2 axes  
Max. output pulses: 200K pulses/s  
Positioning data: 600 data/axis  
Max. connection distance: 2 m



### LD75P4

Number of control axes: 4 axes  
Max. output pulses: 200K pulses/s  
Positioning data: 600 data/axis  
Max. connection distance: 2 m

Differential output



### LD75D1

Number of control axes: 1 axis  
Max. output pulses: 4M pulse/s  
Positioning data: 600 data/axis  
Max. connection distance: 10 m



### LD75D2

Number of control axes: 2 axes  
Max. output pulses: 4M pulse/s  
Positioning data: 600 data/axis  
Max. connection distance: 10 m



### LD75D4

Number of control axes: 4 axes  
Max. output pulses: 4M pulse/s  
Positioning data: 600 data/axis  
Max. connection distance: 10 m

Function	LD75P1	LD75P2	LD75P4	LD75D1	LD75D2	LD75D4
	Open collector output			Differential output		
Positioning control function	●	●	●	●	●	●
Speed control function	●	●	●	●	●	●
Linear interpolation	—	2 axes	2/3/4 axes	—	2 axes	2/3/4 axes
Circular interpolation	—	2 axes	2 axes	—	2 axes	2 axes
OPR control function	●	●	●	●	●	●

## Countless applications are possible

LD77MS□

A variety of control types including positioning control, speed control, torque control, cam control and synchronous control can be implemented easily with simple parameter settings and a sequence program.

### Positioning control

- Support for a multitude of applications thanks to a wide variety of control formats including linear interpolation control (up to 4 axes), 2-axis circular interpolation control, fixed feed control and continuous orbit control.
- Use a sequence program to set the positioning address, speed, etc. for easy automatic operation.
- Quickly implement powerful auxiliary functions such as step operation, target position change, M codes, and the skip function.

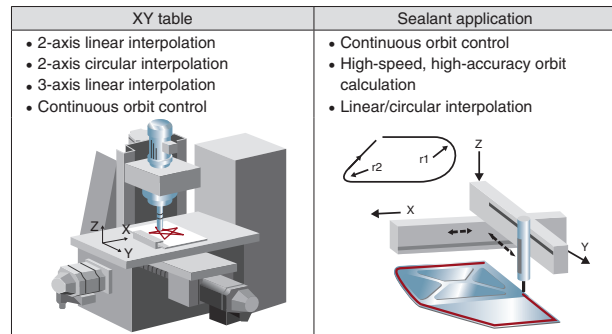

### Speed control and torque control

- Tension control applications such as winding and rewinding are supported.
- Switch from positioning control, to speed and torque control, and back to positioning control. Because the present location is tracked even in speed and torque control mode, it is possible to maintain the current absolute position when returning to positioning control.

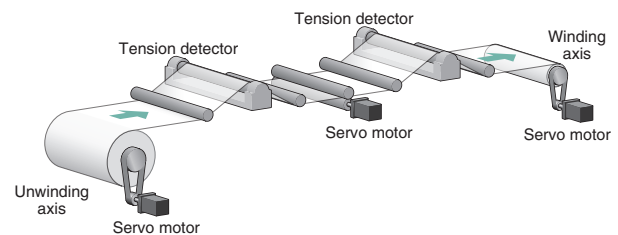

### Synchronous control and cam control

- Cam control may be used alone or combined with synchronous control.

#### Example application for cam control:

To create a movement path around a workpiece using positioning control, axis 2 waits for axis 1 to complete the move from P1 to P2 before it begins moving from P2 to P3. By using cam control, axis 2 does not need to wait for axis 1 to complete its movement and the in position time can be shortened.

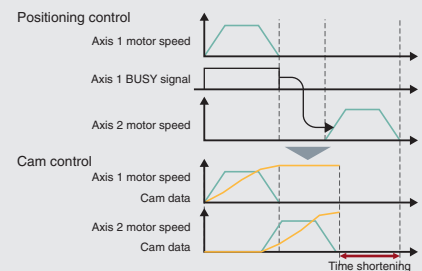
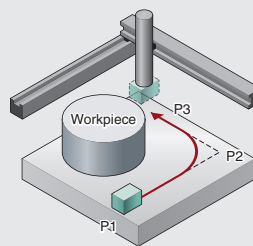

## Many functions in a compact design

LD77MS□

### Use a synchronous encoder with synchronous control

- Input pulses from a synchronous encoder can be used to perform synchronous control and cam control.
- The incremental synchronous encoder can be used by using the LD77MS built-in interface. An option unit is not required.
- To further improve the synchronization accuracy, the phase compensation function, designed to compensate for synchronous encoder delays, can be used.

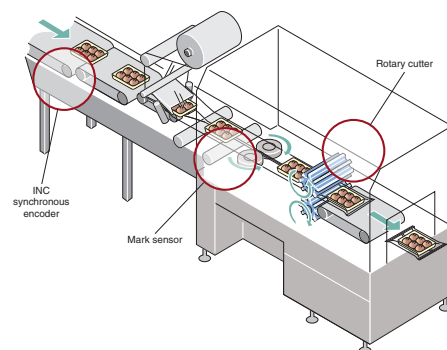

### Standard mark detection function

- The built-in mark detection signal interface allows these units to be used in packaging systems for example, without additional option modules.

### Automatic cam data generation for rotary cutter

- Complicated cam data for rotary cutters can be automatically generated just by specifying a few parameters like the sheet length and synchronization width.

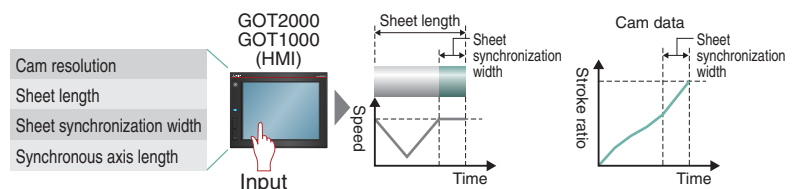

Perfect synchronous control is easy to achieve

LD77MS

Replace mechanical gears, shafts, speed change gears, cams, etc. and generate synchronous control operations using software.

- Complicated programs are unnecessary for synchronous control because it can be implemented easily using parameter settings.
- Start and stop synchronous control for each axis. Use the synchronous control axis and positioning control axis together.
- Convey the travel value of main shaft to the output axis via the clutch.

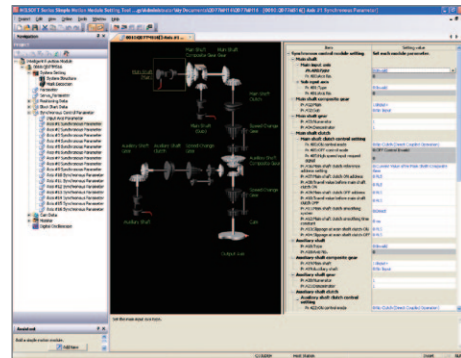

Synchronous Control Parameter Settings

Cam control made simple

LD77MS

Create cam data patterns easily.

- Create cam profiles unrestricted by existing concepts of electronic cam control.
- Change the acceleration, speed, stroke, and jerk while simultaneously seeing how it effects the profile.
- Easily check created cam data by viewing them as thumbnails.
- Import and export cam data in CSV format.

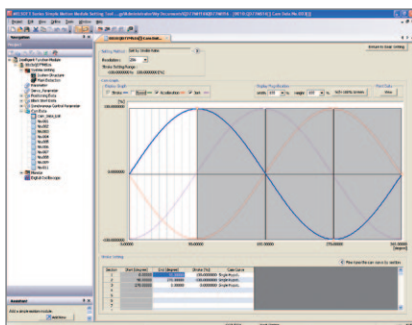

Cam Data

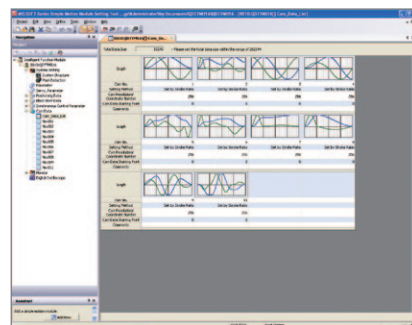

Cam Data List

Simplified debugging and commissioning

LD77MS

Digital oscilloscope function

- Collection of data from the simple motion module is synchronized with the operation cycle and waveform displays to facilitate an efficient start up.
- The assistant function explains each step.
- Use the purpose-based probe setting to easily set frequently-viewed data.
- Sample 16CH word and 16CH bit data and display 8CH words and 8CH bits in real time.

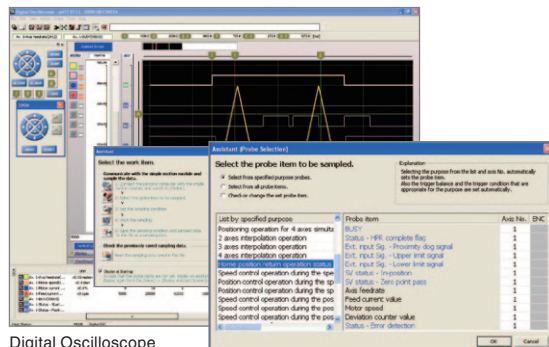

Digital Oscilloscope

Monitor and test functions

- Complete the system installation and perform operational checks easily using powerful monitor and test functions.
- Select items to be displayed on the monitor using a wealth of information monitoring options.
- The test function can be used to check basic operations without a sequence program.

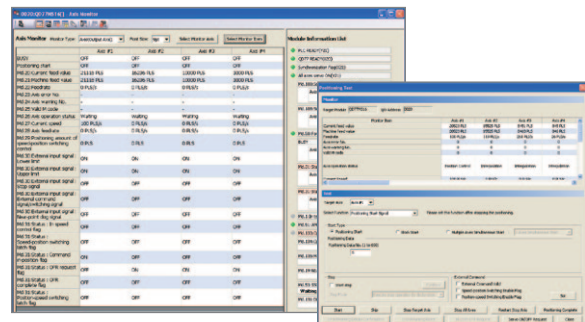

Axis Monitor

Positioning Test

## Specifications

Item		LD77MS2*1	LD77MS4	LD77MS16
Number of control axes		2 axes	4 axes	16 axes
Operation cycle		0.88 ms		0.88 ms/1.77 ms*2
Interpolation function		Linear interpolation (2 axes), Circular interpolation (2 axes)	2-axis/3-axis/4-axis linear interpolation, Circular interpolation (2 axes)	
Control system		PTP (Point To Point) control, path control (both linear and arc can be set), speed control, torque control, speed-position switching control, position-speed switching control		
Acceleration/deceleration process		Trapezoidal acceleration/deceleration, S-curve acceleration/deceleration		
Compensation function		Backlash compensation, Electronic gear, Near pass function		
Synchronous control		External encoder, Cam, Phase Compensation, Cam generated automatically		
Control unit		mm, inch, degree, pulse		
Positioning data		600 data (positioning data No. 1...600) / axis (Can be set with GX Works2 or programmable controller program.)		
Backup		Parameters, positioning data, and block start data can be saved on flash ROM (battery-less backup)		
OPR control	Machine OPR control	Near-point dog method, Count method 1), Count method 2), Data set method, scale origin signal detection method		
	Fast OPR control	●		
	Sub functions	OPR retry, OP shift		
Position control	Position control	Linear control	1-axis linear control, 2-axis linear interpolation control, 3-axis linear interpolation control, 4-axis linear interpolation control*3 (Composite speed, Reference axis speed)	
		Fixed-feed control	1-axis fixed-feed control, 2-axis fixed-feed control, 3-axis fixed-feed control, 4-axis fixed-feed control	
		2-axis circular interpolation control	Sub point designation, center point designation	
	Speed control	1-axis speed control, 2-axis speed control, 3-axis speed control, 4-axis speed control		
	Speed-position switching control	INC mode, ABS mode		
	Position-speed switching control	INC mode		
	Other control	Current value changing	Changing to a new current value using the positioning data, Changing to a new current value using the start No.	
NOP instruction		●		
JUMP instruction		Unconditional JUMP, Conditional JUMP		
LOOP, LEND		●		
High-level positioning control		Block start, Condition start, Wait start, Simultaneous start, Repeated start		
Manual control	JOG operation	●		
	Inching operation	●		
	Manual pulse generator operation	Possible to connect 1 module (Incremental) Unit magnification (1...10000 times)		
Expansion control	Speed-torque control	Speed control without positioning loops, Torque control without positioning loops		
Absolute position system		Connect a battery to the servo amplifier to ensure compatibility		
Synchronous encoder interface		Up to 4 channels (Total of the internal interface, interface via servo amplifier, and interface via the PLC CPU)		
Functions that limit control	Internal interface	1 channel (Incremental)		
	Speed limit function	Speed limit value, JOG speed limit value		
	Torque limit function	Torque limit value_same setting, torque limit value_individual setting		
	Forced stop function	Valid/invalid setting		
	Software stroke limit function	Movable range check with current feed value, movable range check with machine feed value		
Functions that change control details	Hardware stroke limit function	●		
	Speed change function	●		
	Override function	●		
	Acceleration/deceleration time change function	●		
	Torque change function	●		
Other functions	Target position change function	Target position address and target position speed are changeable		
	M code output function	●		
	Step function	Deceleration unit step, Data No. unit step		
	Skip function	Via sequence CPU, Via external command signal		
Teaching function	Teaching function	●		
	Mark detection function	Mark detection mode (Continuous Detection mode, Specified Number of Detections mode, Ring Buffer mode)		
Mark detection function	Mark detection signal	4 points		16
	Mark detection setting	4	4 points/axis	16
Optional data monitor function		●		
Master-slave operation function		●		
Amplifier-less operation function		●		
Digital oscilloscope function		Bit data: 8 channels, Word data: 4 channels		Bit data: 16 channels, Word data: 16 channels*4
Starting time*5	1-axis linear control		0.88 ms	
	1-axis speed control			
	2-axis linear interpolation control (Composite speed)			
	2-axis linear control (Reference axis speed)			
	2-axis circular interpolation control			
	2-axis speed control			
	3-axis linear interpolation control (Composite speed)			
	3-axis linear interpolation control (Reference axis speed)			
	3-axis speed control			
	4-axis linear interpolation control			
4-axis speed control				
Maximum distance between stations [m (ft.)]		100 m		
Maximum number of modules specification		Counts as 2 modules		
Number of occupied I/O points		32 points (I/O assignment: Intelligent 32 points)		
Servo amplifier connection system		SSCNET III/H-compatible (1 system)		
5 V DC internal current consumption		0.55 A	0.7 A	
Weight		0.22 kg		

\*1: The maximum number of control axes for LD77MS2 is two axes. Use LD77MS4 or LD77MS16 to control three or more axes.

\*2: Default value is 1.77 ms. If necessary, check the operation time and change to 0.88 ms.

\*3: 4-axis linear interpolation control is enabled only at the reference axis speed.

\*4: 8CH word data and 8CH bit data can be displayed in real time.

\*5: The starting time varies with conditions. For details, refer to the manual.

## Specifications

Item		LD75P1/LD75D1 <sup>1</sup>	LD75P2/LD75D2 <sup>1</sup>	LD75P4/LD75D4 <sup>1</sup>		
Number of control axes		1 axis	2 axes	4 axes		
Interpolation function		—	2-axis linear interpolation 2-axis circular interpolation	2-axis/3-axis/4-axis linear interpolation, 2-axis circular interpolation		
Control system		PTP (Point To Point) control, path control (both linear and arc can be set), speed control, speed-position switching control, position-speed switching control				
Control unit		mm, inch, degree, pulse				
Positioning data		600 data (positioning data No.1...600) /axis (Can be set with peripheral device or sequence program.)				
Backup		Parameters, positioning data, and block start data can be saved on flash ROM (battery-less backup)				
Positioning control	Positioning control system	PTP*2 control	Increment system, absolute system			
		Speed-position switching control	Increment system, absolute system*3			
		Position-speed switching control	Increment system			
		Path control	Increment system, absolute system			
	Positioning control range	In absolute system		-214748364.8...214748364.7 (μm) -21474.83648...21474.83647 (inch) 0...359.99999 (degree) -2147483648...2147483647 (pulse)		
			In increment system		-214748364.8...214748364.7 (μm) -21474.83648...21474.83647 (inch) -21474.83648...21474.83647 (degree) -2147483648...2147483647 (pulse)	
				In speed-position switching control (INC mode)/ position-speed switching control		0...214748364.7 (μm) 0...21474.83647 (inch) 0...21474.83647 (degree) 0...2147483647 (pulse)
		In speed-position switching control (ABS mode)*3		0...359.99999 (degree)		
			Speed command		0.01...2000000.00 (mm/min) 0.001...2000000.000 (inch/min) 0.001...2000000.000 (degree/min) 1...4000000 (pulse/s)	
		Acceleration/deceleration system selection		Trapezoidal acceleration/deceleration, S-curve acceleration/deceleration		
	Acceleration/deceleration time		1...8388608 ms			
	Sudden stop deceleration time		Four patterns can be set for each of acceleration time and deceleration time 1...8388608 ms			
	OPR method		6 types			
Starting time*4			1-axis linear control	1.5 ms		
			1-axis speed control	1.5 ms		
			2-axis linear interpolation control (Composite speed)	1.5 ms		
			2-axis linear control (Reference axis speed)	1.5 ms		
			2-axis circular interpolation control	2.0 ms		
			2-axis speed control	1.5 ms		
			3-axis linear interpolation control (Composite speed)	1.7 ms		
			3-axis linear interpolation control (Reference axis speed)	1.7 ms		
			3-axis speed control	1.7 ms		
			4-axis linear interpolation control	1.8 ms		
		4-axis speed control	1.8 ms			
Maximum output pulse	LD75P□	200 kpulse/s				
	LD75D□	4 Mpulse/s				
Maximum connection distance between drive units	LD75P□	2 m				
	LD75D□	10 m				
Maximum number of modules specification		Counts as 2 modules				
Number of occupied I/O points		32 points (I/O assignment: Intelligent 32 points)				
External interface		40-pin connector		40-pin connector x2		
5 V DC internal current consumption	LD75P□	0.44 A	0.48 A	0.55 A		
	LD75D□	0.51 A	0.62 A	0.76 A		
Weight		0.18 kg				

\*1: LD75P□ refers to the open collector output type, and LD75D□ refers to the differential driver output type.

\*2: The abbreviation for Point To Point, referring to position control.

\*3: In speed-position switching control (ABS mode), "degree" is the only control unit available.

\*4: Starting times may vary depending on conditions. For details, refer to the manual.

## High-Speed Counter Modules

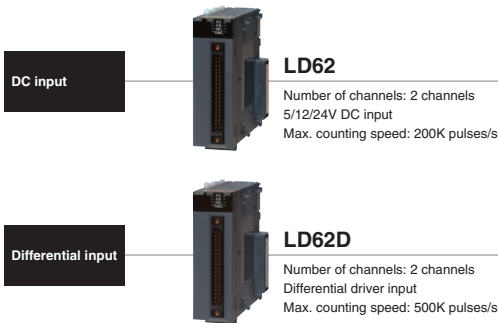

Function	LD62	LD62D
	DC input	Differential input
Linear counter function	●	●
Ring counter function	●	●
Coincidence output function	●	●
Preset function	●	●
Disable count function	●	●
Latch counter function	●	●
Sampling counter function	●	●
Periodic pulse counter function	●	●

### Specifications

Item		LD62 [DC input]	LD62D [Differential input]	
Number of channels		2 channels		
Counting speed switch setting		10K pulses/s, 100K pulses/s, 200K pulses/s	10K pulses/s, 100K pulses/s, 200K pulses/s, 500K pulses/s	
Count input signal	Phase	1-phase input (multiple of 1/2), CW/CCW, 2-phase input (multiple of 1/2/4)		
	Signal level (A, B)	5/12/24 V DC 2...5 mA	EIA Standard RS-422-A differential type line driver level (Equivalent with AM26LS31 (manufactured by Texas Instruments Japan Limited))	
Counter	Maximum counting speed*1	200K pulses/s	500K pulses/s	
	Counting range	-2147483648...2147483647		
	Type	UP/DOWN preset counter and ring counter functions		
	Minimum count pulse width (Duty ratio 50%)	10K pulses/s	50 μs	10K pulses/s
		100K pulses/s	5 μs	100K pulses/s
200K pulses/s		2.5 μs	200K pulses/s	
Minimum phase differential for 2-phase input	10K pulses/s	25 μs	10K pulses/s	
	100K pulses/s	2.5 μs	100K pulses/s	
	200K pulses/s	1.25 μs	200K pulses/s	
Coincidence output	Comparison range	Binary with 32-bit code (-2147483648...2147483647)		
	Comparison result	Set value < Count value Set value = Count value Set value > Count value		
External input	Preset	5/12/24 V DC 2...5 mA		
	Function start	5/12/24 V DC 2...5 mA (Differential type line drivers conforming to EIA standard RS-422-A are also applicable.)		
External output	Minimum input response time	OFF to ON	Function start: 0.5 ms	
	Output voltage/current	ON to OFF	Function start: 1 ms	
External output	Coincidence output	2 points/channel		
	Output response time	OFF to ON	12...24 V DC 0.5 A	
External output	Output response time	ON to OFF	≤ 0.1 ms (rated load, resistive load)	
	Maximum number of modules specification	Counts as 1 module		
Number of occupied I/O points		16 points (I/O assignment: Intelligent 16 points)		
External interface		40-pin connector		
5 V DC internal current consumption		0.31 A	0.36 A	
Weight		0.13 kg		

\*1: The counting speed is affected by the rising/falling pulse speed. For details, refer to the corresponding manual.

## Seamless integration of multiple networks

The MELSEC L Series is part of a family of products all interconnected across various levels of automation. Based on the seamless message protocol (SLMP<sup>®1</sup>), data flows transparently between the sensor level and the management level across multiple industry-standard automation networks. CC-Link IE, Asia's No. 1 industrial network, realizes fast gigabit data transmission speeds, further optimizing the manufacturing cycle. In addition, the SSCNET 3/H high-speed motion control network further enhance the factory-wide connectivity solution.

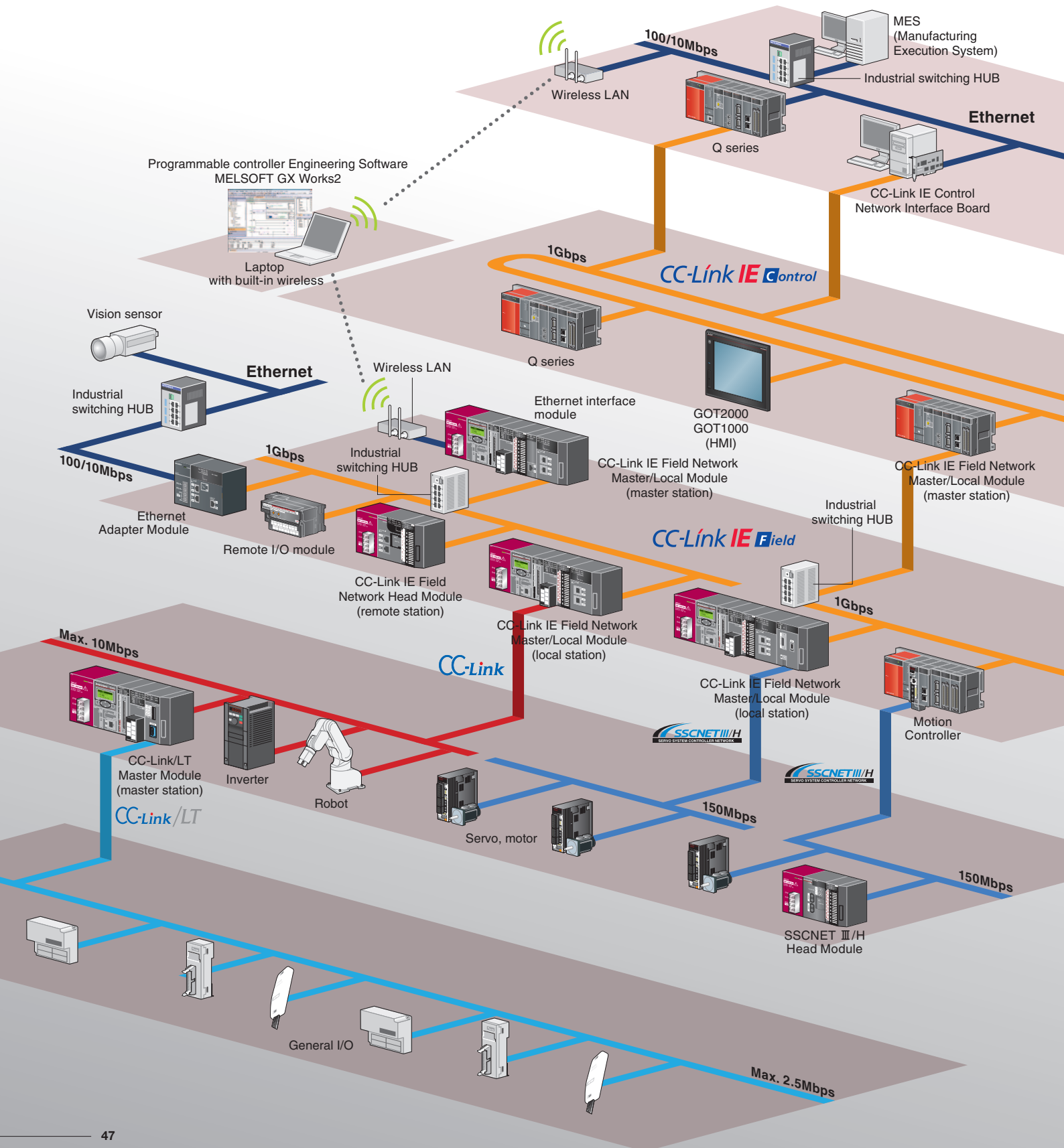



## Seamless communication

Seamless data communication through Ethernet, CC-Link IE Control, CC-Link IE Field, and CC-Link networks allow easy access to information, no matter where it resides on the network. Through this technology, it is possible to “drill down” from the Enterprise or IT layer through multiple networks accessing programming controllers using GX Works2 programming or other related software.

In addition, many devices supporting SLMP\*1 such as vision sensors and RFID controllers may be connected to the CC-Link IE Field Network.

\*1: SLMP (SeamLess Message Protocol) is a protocol advocated by the CC-Link Partner Association.

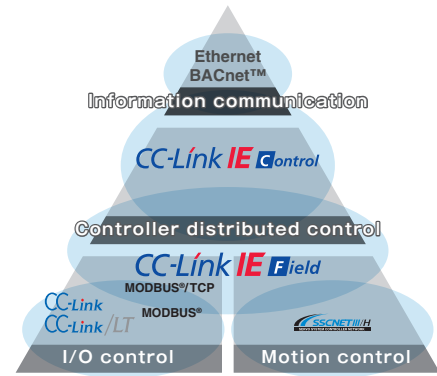

### CC-Link IE Control

CC-Link IE Control is a high-reliability distributed control network designed to handle very large data communications (128K word) over a high-speed (1 Gbps) dual-loop optical cable topology.  
 \*: L Series does not support the CC-Link IE Control Network.

### CC-Link IE Field

CC-Link IE Field is a versatile gigabit Ethernet-based network integrating controller, I/O control, safety control, and motion control in a flexible wiring topology supporting star, ring, and line configurations.  
 \*: Compatible modules: LJ71GF11-T2, LJ72GF15-T2

### CC-Link

CC-Link is a high-speed and high-reliable deterministic I/O control network which realizes reduced wiring whilst offering multi-vendor compatible products. This open field network is a global standard originating from Japan and Asia.  
 \*: Compatible modules: L26CPU-BT, L26CPU-PBT, LJ61BT11

### SSCNET III/H

SSCNET III/H is a dedicated high-speed, high-performance, and highly reliable servo system control network that offers flexible long distance wiring capabilities based on optical fiber cable topology.  
 \*: Compatible modules: LD77MS2, LD77MS4, LD77MS16, LJ72MS15

### CC-Link/LT

CC-Link/LT is a wire-saving sensor level network which is designed for use in panels between simple discrete devices. Its wiring system is based on reducing incorrect wiring and is based on CC-Link realizing high-speed and robust noise resistance features.  
 \*: Compatible module: LJ61CL12

### MODBUS®

L-Series is now supporting the MODBUS® protocol network, realizing easy communication, with various MODBUS® slave devices compatible with Ethernet MODBUS®/TCP or RS-232/422/485 serial communication.  
 \*: Module supporting MODBUS®/TCP: L02CPU(-P), L06CPU(-P), L26CPU(-P), L26CPU(-P)BT, LJ71E71-100 (master only)  
 \*: Modules supporting MODBUS®: L6ADP(-R2/R4), LJ71C24(-R2) (master only)

### BACnet™

This network supports the communication protocol standard BACnet™ client function. This network is mainly used to monitor and control air-conditioning, lighting and fire detection, etc. in building automation system applications.  
 \*: Compatible modules: L02CPU(-P), L06CPU(-P), L26CPU(-P), L26CPU(-P)BT, LJ71E71-100 (client only)

Network	Application	Enterprise level network		Device level network			Sensor level network
		Information communication	Controller distributed control	I/O control	Safety control	Motion control	Control
Ethernet		●					
CC-Link IE Control			●				
CC-Link IE Field			●	●	●	●	
CC-Link				●			
CC-Link/LT							●
SSCNET III/H						●	
BACnet™		●					
MODBUS®/TCP			●				
MODBUS®				●			

L Series Features

CPU

I/O

Analog/  
Temperature  
Control

Simple Motion/  
Positioning

High-Speed  
Counter

Network

Digital Link  
Sensor

Software

Related Products

## CC-Link IE Field Network Master/Local Module



### Easy to configure settings

Network parameters are configured using the engineering tool, GX Works2. Only the master station needs to be configured, thereby greatly simplifying the network setup. Updating the system configuration is a breeze.

Master station settings are all that is required!

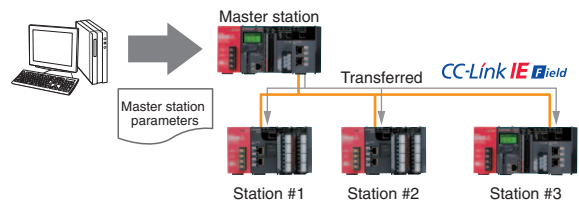

### Flexible network topology

Various network topologies are supported including star, line, star and line combination, and ring. When hubs\*1 are used, new equipment can be added and machine layouts can be changed easily.

\*1: Hubs cannot be used in a ring configuration.

#### Examples of network topologies

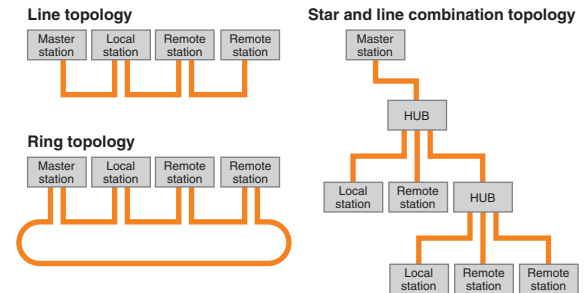

#### Specifications

Item		LJ71GF11-T2	
Transmission speed		1 Gbps	
Maximum overall cable distance (Maximum transmission distance)	Line topology	12000 m (when cables are connected to 1 master station and 120 slave stations)	
	Star topology	Depends on the system configuration	
	Ring topology	12100 m (when cables are connected to 1 master station and 120 slave stations)	
Maximum number of connected stations	Master station	1 station (Up to 120 slave stations can be connected to the master station)	
	Local station	120 stations	
Maximum link points per station	Remote register (RWw)	8192 points, 16 KB	
	Remote register (RWr)	8192 points, 16 KB	
	Remote input (RX)	16384 points, 2 KB	
	Remote output (RY)	16384 points, 2 KB	
Maximum link points per station	Master station	Remote register (RWw)	8192 points, 16 KB
		Remote register (RWr)	8192 points, 16 KB
		Remote input (RX)	16384 points, 2 KB
		Remote output (RY)	16384 points, 2 KB
	Local station	Remote register (RWw)	8192 points, 16 KB (also including the send range of own station)
		Remote register (RWr)	8192 points, 16 KB
		Remote input (RX)	16384 points, 2 KB
		Remote output (RY)	16384 points, 2 KB (also including the send range of own station)
Network topology		Line topology, star topology (Coexistence of line topology and star topology is possible.), and ring topology	
Communication method		Token passing method	
Communication port		CC-Link IE Field Network port x 2	
RAS function		Automatic return, Slave station disconnection, Loopback function	
Connection cable*2		Ethernet cable of category 5e or higher (Double shielded cable) which satisfies 1000BASE-T standard	
Maximum number of modules specification		Counts as 2 modules	
Number of occupied I/O points		32 points (I/O assignment: Intelligent 32 points)	
5 V DC internal current consumption		0.89 A	
Weight		0.27 kg	

\*2: Standard (straight type) cable

## CC-Link IE Field Network Head Module

CC-Link IE Field



**LJ72GF15-T2**

CC-Link IE Field Intelligent device station

Communication speed: 1 Gbps

Remote I/O: 2048 points

Remote register: 1024 words

RAS function

\*: END cover is included.

CC-Link IE Field

## CC-Link IE Field Network remote I/O station

L Series I/O and intelligent function modules can be connected to the remote I/O head module without a dedicated CPU. There are many benefits to using intelligent device stations including reduced CPU and wiring costs, great flexibility in selecting I/O and intelligent function modules, and compact unit size.

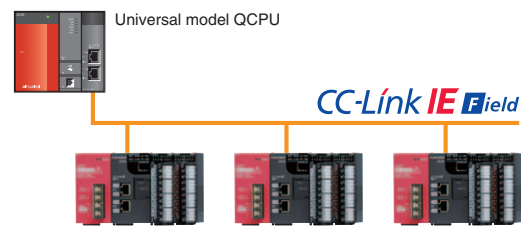

Modules compatible with the CC-Link IE Field Network head module

Item	
I/O module	Input, output, I/O combined
Analog module	Analog input, analog output, analog input/output
Temperature control module	
Simple motion module	
Positioning module	
High-speed counter module	
Network module	CC-Link, CC-Link/LT, serial communication
AnyWireASLINK master module	

## RAS (Reliability, Availability, Serviceability) functions

One feature of RAS is to store all remote station error histories in the master station's latched memory. This preserves the error information in one place in the event of power loss and allows for easy troubleshooting. Other RAS features include network event logging, unit error logging, and testing and monitoring capabilities.

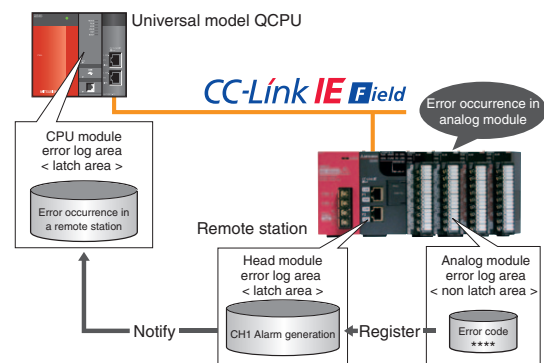

## Specifications

Item	LJ72GF15-T2	
Transmission speed	1 Gbps	
Maximum overall cable distance (Maximum transmission distance)	Line network topology	12000 m (with 1 master and 120 slaves connected)
	Star network topology	Depends on the system configuration
	Ring network topology	12100 m (with 1 master and 120 slaves connected)
Transmission path	Line, star, line and star mixed, or ring topology	
Communication method	Deterministic (token passing)	
Maximum number of modules specification*1	10	
Communication port	CC-Link IE Field Network port x 2	
RAS function	Network event logging, unit error logging, testing, monitoring, and error history preservation function	
Connection cable*2	Ethernet cable of category 5e or higher (Double shielded cable) which satisfies 1000 BASE-T standard	
5 V DC internal current consumption	1.00 A	
Weight	0.23 kg	

\*1: The total number of modules that can be mounted to a CC-Link IE Field Network head module. (END cover and power supply module are not included.)

\*2: Standard (straight type) cable.

L Series Features

CPU

I/O

Analog/  
Temperature  
Control

Simple Motion/  
Positioning

High-Speed  
Counter

Network

Digital Link  
Sensor

Software

Related Products

## CC-Link Master/Local Module



### Connect with a huge selection of device types using CC-Link

With such a large selection of CC-Link open network compatible devices, constructing a control system is easy.

Even applications requiring vast amounts of data transmissions can be satisfied because CC-Link Ver.2.0 is supported.

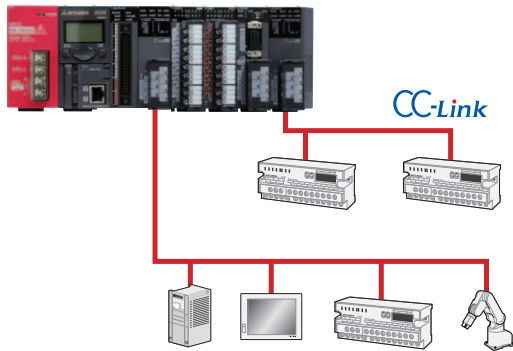

### Local stations do not require transmission speed settings

#### Transmission speed auto-tracking function

When used as a local station, no transmission speed setting is required; the setting is made through automatic detection of the master station setting. The current transmission speed is indicated by an LED on the front surface of the module.

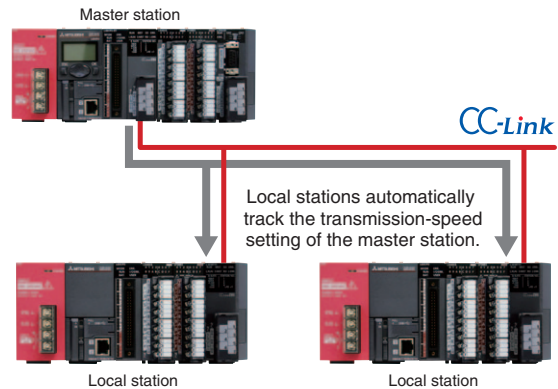

### Specifications

Item	LJ61BT11	
Transmission speed	156 kbps/625 kbps/2.5 Mbps/5 Mbps/10 Mbps	
Maximum overall cable distance (Maximum transmission distance)	1200 m (without repeater, varies according to the transmission speed)	
Maximum number of connected stations (master station)	64	
Number of occupied stations (local station)	1...4 stations (The number of stations can be switched using the GX Works2 parameter setting)	
Maximum number of link points per system*2	Remote I/O (RX, RY)	2048 points
	Remote register (RWw)	256 points (master station → remote device station/local station/intelligent device station/standby master station)
	Remote register (RWr)	256 points (remote device station/local station/intelligent device station/standby master station → master station)
Number of link points per station*2	Remote I/O (RX, RY)	32 points (local station is 30 points)
	Remote register (RWw)	4 points (master station → remote device station/local station/intelligent device station/standby master station)
	Remote register (RWr)	4 points (remote device station/local station/intelligent device station/standby master station → master station)
Communication method	Broadcast polling method	
Synchronous method	Frame synchronization method	
Encoding method	NRZI method	
Transmission path	Bus (RS-485)	
Transmission format	Conforms to HDLC	
Error control system	CRC (X <sup>16</sup> +X <sup>12</sup> +X <sup>6</sup> +1)	
RAS function	Automatic return function	
	Slave station cut-off function	
	Error detection via link special relay/register	
Connection cable	CC-Link dedicated cables compatible with Ver. 1.10	
Maximum number of modules specification	Counts as 1 module	
Number of occupied I/O points	32 points (I/O assignment: Intelligent 32 points)	
5 V DC internal current consumption	0.46 A	
Weight	0.15 kg	

\*2: Indicates the number of link points for Remote net Ver.1 mode.

## CC-Link/LT Master Module



**LJ61CL12**  
 CC-Link/LT master station  
 Max. communication speed: 2.5 Mbps  
 Remote I/O: 1024 points\*1  
 \*1: When in 16-point mode



### High speed equipment response

CC-Link/LT has an excellent response time. With 64 stations and a transmission speed of 2.5 Mbps, the maximum link scan time is just 1.2 ms. According to the transmission distance required, it is possible to select speeds of 2.5 Mbps, 625 kbps, or 156 kbps.

■ CC-Link/LT link scan time (using a transmission speed of 2.5 Mbps)

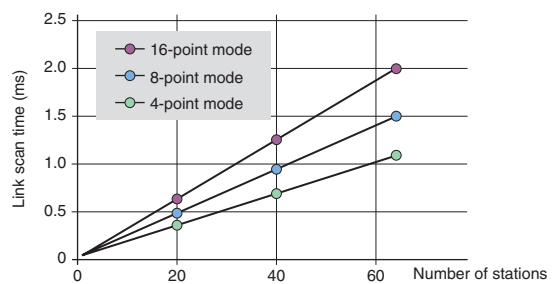

### Simple networking that 'just works'

There are no confusing parameters settings to make, and with remote I/O, only the master station needs to set the transmission speed.

#### ■ Specifications

Item		LJ61CL12			
Point mode		4-point mode	8-point mode	16-point mode	
Control specifications	Maximum link points (the same I/O address used)	256 points (512 points)	512 points (1024 points)	1024 points (2048 points)	
	Link points per station (the same I/O address used)	4 points (8 points)	8 points (16 points)	16 points (32 points)	
	Link scan time	32 stations connected	Points	128 points	256 points
			2.5 Mbps	0.7 ms	0.8 ms
			625 kbps	2.2 ms	2.7 ms
		64 stations connected	156 kbps	8.0 ms	10.0 ms
			Points	256 points	512 points
			2.5 Mbps	1.2 ms	1.5 ms
	625 kbps	4.3 ms	5.4 ms		
	156 kbps	15.6 ms	20.0 ms	27.8 ms	
Communication specifications	Transmission speed	2.5 Mbps/625 kbps/156 kbps			
	Communication method	BITR method (Broadcast polling + Interval Timed Response)			
	Network topology	T-branch type			
	Error control system	CRC			
	Number of connectable modules	64			
	Remote station number	1...64			
	Installation position of master station	End of a trunk line			
	RAS function	Network diagnostics, internal loopback diagnostics, slave station cutoff function, automatic return function			
Connection cable*2	Dedicated flat cable (0.75 mm <sup>2</sup> × 4)*3, VCTF cable*4, flexible cable*3				
Maximum number of modules specification	Counts as 1 module				
Number of occupied I/O points*5	16, 32, 48, 64, 128, 256, 512, or 1024 points (I/O assignment: Intelli.)				
5 V DC internal current consumption	0.16 A				
24 V DC power supply*6	Voltage	20.4...28.8 V DC			
	Current consumption	0.03 A			
	Current on startup	0.07 A			
Weight	0.12 kg				

\*2: When the cables other than dedicated flat cables, VCTF cables, and flexible cables are used, performance of CCLink/LT is not guaranteed.  
 \*3: Use the dedicated flat cables and flexible cables accredited by CC-Link Partner Association. CC-Link Partner Association website: <http://www.cc-link.org>  
 \*4: Refer to the manual for details regarding VCTF cable specifications.  
 \*5: Set the number of occupied I/O points using the operation setting switch. Refer to the manual for details.  
 \*6: 24 V DC power supply is supplied through the dedicated power supply or power supply adapter.

L Series Features  
 CPU  
 I/O  
 Analog/ Temperature/ Control  
 Simple Motion/ Positioning  
 High-Speed Counter  
 Network  
 Digital Link Sensor  
 Software  
 Related Products

## SSCNET III/H Head Module



### SSCNET III/H remote station

The SSCNET III/H head module is used to connect the MELSEC-L Series I/O and intelligent function modules to the SSCNET III/H network.

Functioning as the motion controller's remote station, flexible system configuration can be achieved while realizing reduced system wiring and a smaller footprint.

In addition, modules installed on the SSCNET III/H head module can be used as a motion controller input/output using cyclic transmission.

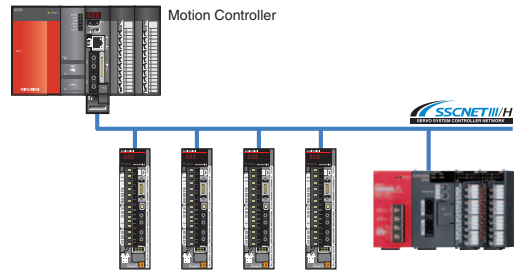

■ SSCNET III/H Head Module compatible modules

Product	
I/O module	Input, Output, I/O Combined
Analog module	Analog input, analog output, analog I/O combined
High-speed counter modules	

■ Compatible motion controller

Category	Model
Motion CPU	Q172DSCPU
	Q173DSCPU
Standalone motion controller	Q170MSCPU

■ Specifications

Item	LJ72MS15	
Maximum link points per network	RWr, RX	256 bytes
	RWw, RY	256 bytes
Maximum link points per station	RWr, RX	64 bytes
	RWw, RY	64 bytes
Communication speed	150 Mbps	
Maximum connectable stations per network*1	Communication cycle: 888 μs	4
	Communication cycle: 444 μs	2
	Communication cycle: 222 μs	1
Maximum station-to-station distance	POF type: 20 m, H-PCF type: 50 m	
Connection method	Daisy chain connection (Regenerative relay system with a servo amplifier)	
Synchronous method	Synchronization of the control cycle and communication cycle that synchronize with the data transmission of the motion controller	
Communication cycle	222 μs/444 μs/888 μs	
Maximum number of modules specification*2	10	
Communication port	SSCNET III/H port x2	
Connection cable	SSCNET III cable (optical fiber cable)	
5 V DC internal current consumption	0.55 A	
Weight	0.20 kg	

\*1: This number includes only head modules. Servo amplifiers are not included.

\*2: Total number of occupied modules that can be mounted on SSCNET III/H head module. (Does not include the END cover or power supply module.)

## Ethernet Interface Module



**LJ71E71-100**  
 Communication speed: 100 Mbps/10 Mbps  
 MELSOFT connection  
 SLMP communication (MC protocol)  
 Predefined protocol support function  
 E-mail function  
 Web function

**BACnet™**  
**MODBUS®/TCP**

## Modify/collect CPU data from other devices

### SLMP (MC protocol) communication\*1

SLMP (Seamless Message Protocol) realizes seamless communication across devices on Ethernet that support the SLMP protocol.

\*1: This function can be used with modules with first five serial number digits are "15042" or later.

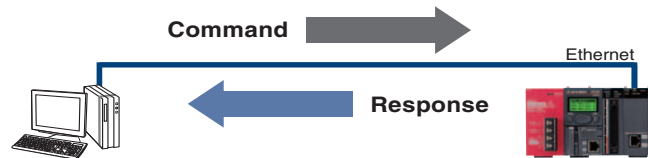

### MELSOFT connection

The MELSOFT connection feature realizes the connection to various MELSOFT products including the GX Works2 programming tool. In addition, by using together with the MX Component communication support tool (optional product), custom communications programs can be created, without having to consider any dedicated protocol (send/receive procedure).

## Easily connect to BACnet™ and MODBUS®/TCP

### Predefined Protocol support function

Use the GX Works2 Predefined Protocol support function to easily set the required protocol for communicating with other devices.

- ▶ Selecting from the communication protocol library  
Easily communicate with target devices by selecting a prepared protocol. The communication protocol library supports the SLMP, MODBUS®/TCP and BACnet™ client functions.
- ▶ Randomly preparing and editing a protocol

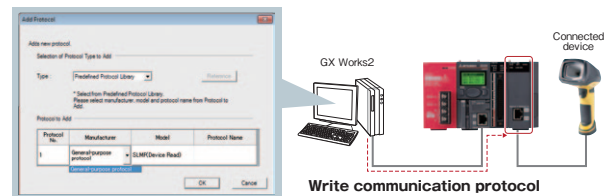

By creating a random protocol with the predefined protocol support function, data can be exchanged with a protocol that matches the target device.

## Specifications

Item		LJ71E71-100	
Standard		100 BASE-TX	10 BASE-T
Transmission specifications	Data transmission speed	100 Mbps	10 Mbps
	Interface	RJ45 (AUTO MDI/MDI-X)	
	Communication mode	Full duplex/Half duplex	Half duplex
	Transmission method	Base band	
	Maximum segment length	100 m (length between a hub and node)*2	
Sending/receiving data storage memory	Maximum number of cascade connections	Cascade connection (maximum of 2 levels)*3	Cascade connection (maximum of 4 levels)*3
	Number of simultaneous open connections	16 connections (Connections usable on a program)	
	Fixed buffer	1K word × 16	
Attachment	Random access buffer	6K words × 1	
	E-mail	6K words × 1	
		Main text	960 words × 1
Maximum number of modules specification	Counts as 1 module		
Number of occupied I/O points	32 points (I/O assignment: Intelligent 32 points)		
5 V DC internal current consumption	0.60 A		
Weight	0.18 kg		

\*2: For the maximum segment length (a length between hubs), consult with the manufacturer of the switching hub used.

\*3: This applies when a repeater hub is used. For the number of levels that can be constructed when a switching hub is used, consult with the manufacturer of the switching hub used.

## Serial Communication Modules

RS-232,  
RS-422/485



### LJ71C24

Max. communication speed: 230.4 kbps<sup>\*1</sup>  
MC protocol communications  
Predefined protocol support function  
<sup>\*1</sup>: Available for only channel 1

MODBUS®

RS-232



### LJ71C24-R2

Max. communication speed: 230.4 kbps<sup>\*1</sup>  
MC protocol communications  
Predefined protocol support function  
<sup>\*1</sup>: Available for only channel 1

MODBUS®

### Quick connection using predefined protocols

The predefined protocol enables easy setup of protocols to communicate with external devices using GX Works2. Connections are quickly setup by selecting the target device from the communications protocol library.

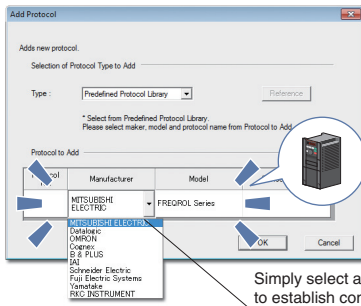

### Easy to create/edit of predefined protocols

Easily create or edit predefined protocols from within the communications library. Even if the target device protocol is not listed, it can be added easily to the existing library.

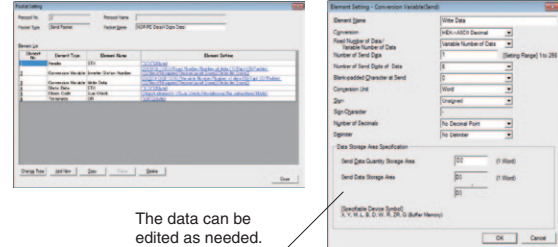

The data can be edited as needed.

### Specifications

Item		LJ71C24	LJ71C24-R2																		
Interface	CH 1	RS-232 compliant (D-Sub 9P female)	RS-232 compliant (D-Sub 9P female)																		
	CH 2	RS-422/485 compliant (2-piece terminal block)	RS-232 compliant (D-Sub 9P female)																		
Communication system	Line	Full-duplex/half-duplex communications																			
	MC protocol	Half-duplex communications																			
	Predefined protocol	Full-duplex/half-duplex communications																			
	Nonprocedural protocol	Full-duplex/half-duplex communications																			
Synchronization method		Asynchronous method																			
Transmission speed		50 bps/300 bps/600 bps/1200 bps/2400 bps/4800 bps/9600 bps/14.4 kbps/ 19.2 kbps/28.8 kbps/38.4 kbps/57.6 kbps/115.2 kbps/230.4 kbps Transmission speed 230.4 kbps is only available for channel 1. Total transmission speed of two interfaces is available up to 230.4 kbps. Total transmission speed of two interfaces is available up to 115.2 kbps when the communication data monitoring function is used.																			
Data format	Start bits	1																			
	Data bits	7 or 8																			
	Parity bits	1 (vertical parity) or none																			
	Stop bits	1 or 2																			
Error detection	Parity check	All protocols and when ODD/EVEN is selected by parameter.																			
	Sum check code	MC protocol/bidirectional protocol selected by parameter. For the predefined protocol, whether or not a sum check code is needed depends on the selected protocol. Nonprocedural protocol selected by user frame.																			
Transmission control	<table border="1"> <thead> <tr> <th></th> <th>RS-232</th> <th>RS-422/485</th> </tr> </thead> <tbody> <tr> <td>DTR/DSR (ER/DR) control</td> <td>Enabled</td> <td>Disabled</td> </tr> <tr> <td>RS/CS control</td> <td>Enabled</td> <td>Disabled</td> </tr> <tr> <td>CD signal control</td> <td>Enabled</td> <td>Disabled</td> </tr> <tr> <td>DC1/DC3 (Xon/Xoff) control</td> <td>Enabled</td> <td>Enabled</td> </tr> <tr> <td>DC2/DC4 control</td> <td>Enabled</td> <td>Enabled</td> </tr> </tbody> </table>				RS-232	RS-422/485	DTR/DSR (ER/DR) control	Enabled	Disabled	RS/CS control	Enabled	Disabled	CD signal control	Enabled	Disabled	DC1/DC3 (Xon/Xoff) control	Enabled	Enabled	DC2/DC4 control	Enabled	Enabled
		RS-232	RS-422/485																		
	DTR/DSR (ER/DR) control	Enabled	Disabled																		
	RS/CS control	Enabled	Disabled																		
	CD signal control	Enabled	Disabled																		
DC1/DC3 (Xon/Xoff) control	Enabled	Enabled																			
DC2/DC4 control	Enabled	Enabled																			
• DTR/DSR signal control and DC code control are selected by the user.																					
Maximum number of modules specification	Counts as 1 module																				
Number of occupied I/O points	32 points (I/O assignment: Intelligent 32 points)																				
5 V DC internal current consumption	0.39 A	0.26 A																			
Weight	0.17 kg	0.14 kg																			



## AnyWireASLINK Master Module

AnyWireASLINK



**LJ51AW12AL DB**

AnyWireASLINK master station  
 Transmission distance: Max. 200 m  
 Data I/O: Max. 512 points\*1  
 Number of connected stations: Max. 128 modules  
 \*1: 256 input points/256 output points

**AnyWireASLINK**

### Linking the sensor I/O with the programmable controller

The AnyWireASLINK master module links the sensor inputs and outputs to the programmable controller.

The module enables flexible layout of miniature sensors with 512 I/O points.

The sensor power can be supplied to the AnyWireASLINK transmission line (2-wire) for communication, allowing sensors to be added easily.

With the MELSEC-Q/L/F Series, faulty sensors can be detected and the slave module settings can be managed at once by GX Works2 engineering environment, further reducing the engineering time.

#### Basic configuration

Either the 2-wire type or 4-wire slave device can be selected according to the load current for AnyWireASLINK. In addition to the 2-wire type, a 4-wire type can also be used by supplying the local power.

#### 2-wire type

If the load current is low, 2-wire type (non-insulated) slave devices can be used without an external power supply.

#### 4-wire type

The 4-wire type (insulated) slave devices require an external 24 V DC power supply to satisfy large load current applications, for example.

#### Configuration with 2-wire type (with no local power feed)

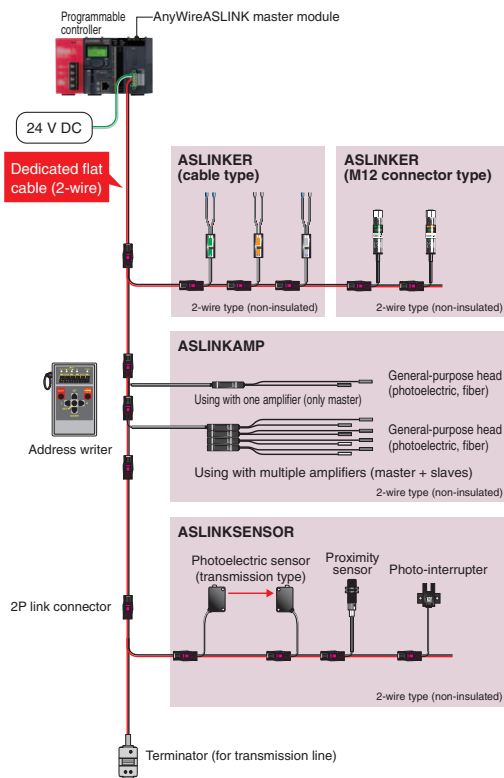

#### Configuration with 2-wire/4-wire type (with local power feed)

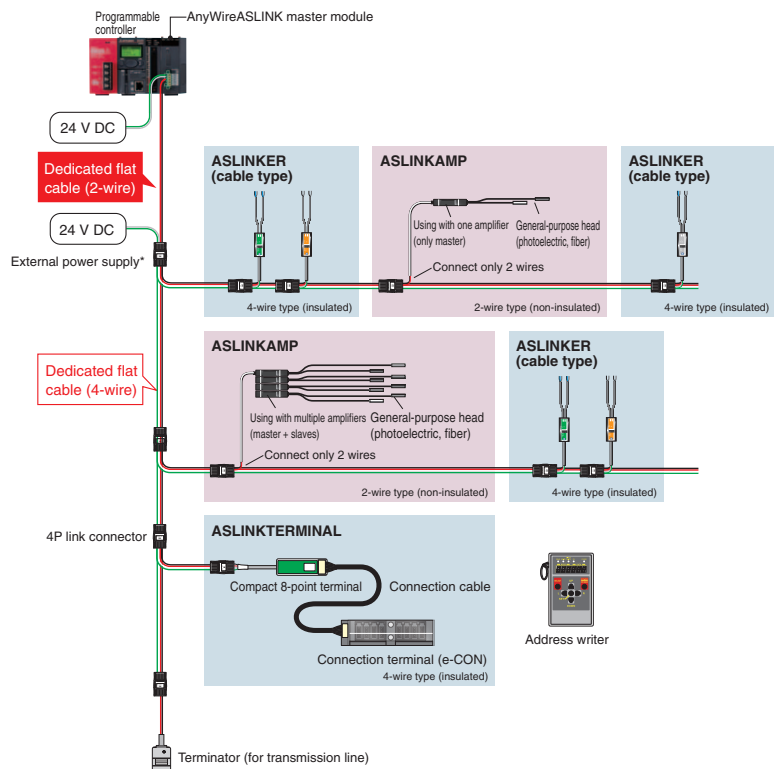

\* External power for 4-wire type wiring.

### Preventing intermittent operation stops

AnyWireASLINK can be used to monitor and save the sensor information within the programmable controller. Parameter settings of the AnyWireASLINK can also be changed via the programmable controller. Perform “Preventive maintenance” with this function to prevent intermittent stops before they happen.

#### Prevent intermittent stops with preventive maintenance!

- Start maintenance early by checking the incoming light amount.
- Change the ON/OFF sensitivity to keep operating up to the maintenance period.

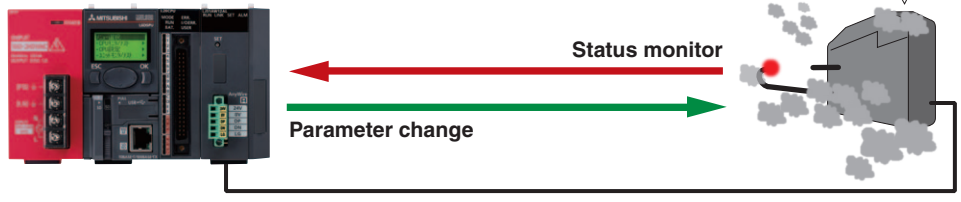
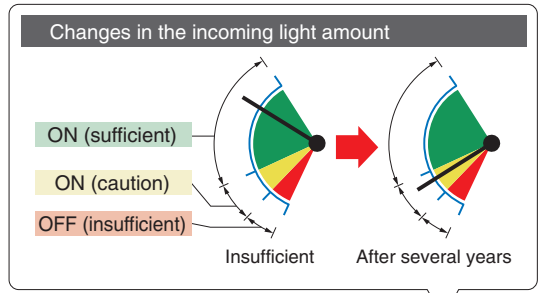

### Reducing the setup time, and providing the traceability

AnyWireASLINK enables the set value to be registered at once to multiple sensors via a GOT (HMI) or personal computer. Also, the initial set values can be re-confirmed easily without having to read each sensor individually.

- Register set values to multiple sensors, and automatically read the initial set values.

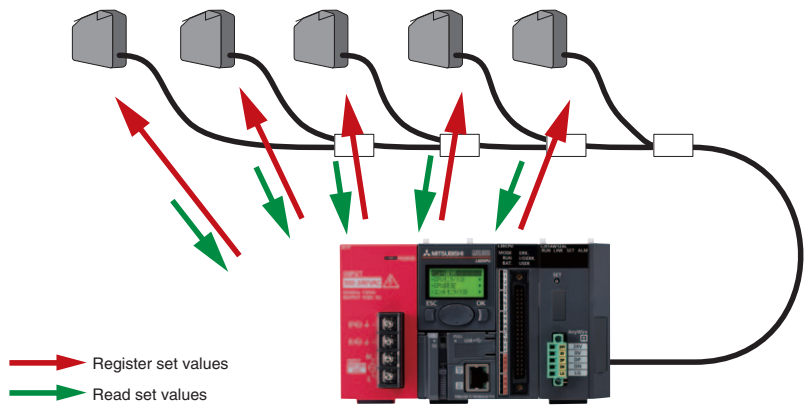

## Specifications

Item	LJ51AW12AL DB
Transmission clock	27.0 kHz
Maximum transmission distance (overall length)	200 m <sup>*1</sup>
Transmission method	DC power superimposed total frame cyclic method
Connection style	Bus type (multi-drop method, T-branch method, tree branch method)
Transmission protocol	Dedicated protocol (AnyWireASLINK)
Error control	Checksum, double verification method
Number of connected I/O points	Max. 512 points (256 input points/256 output points)
Number of connected modules	Max. 128 modules (varies according to each slave module's current consumption)
RAS function	Transmission cable break position detection function, transmission cable short-circuit detection function, transmission power drop detection function
Transmission cable (DP, DN)	<ul style="list-style-type: none"> <li>UL compatible universal 2-wire cable (VCTF, VCT 1.25 mm<sup>2</sup>, 0.75 mm<sup>2</sup>, rated temperature 70°C or more)</li> <li>UL compatible universal cable (1.25 mm<sup>2</sup>, 0.75 mm<sup>2</sup>, rated temperature 70°C or more)</li> <li>Dedicated flat cable (1.25 mm<sup>2</sup>, 0.75 mm<sup>2</sup>, rated temperature 90°C)</li> </ul>
Power cable (24 V, 0 V)	<ul style="list-style-type: none"> <li>UL compatible universal 2-wire cable (VCTF, VCT 0.75 mm<sup>2</sup>...2.0 mm<sup>2</sup>, rated temperature 70°C or more)</li> <li>UL compatible universal cable (0.75 mm<sup>2</sup>...2.0 mm<sup>2</sup>, rated temperature 70°C or more)</li> <li>Dedicated flat cable (1.25 mm<sup>2</sup>, 0.75 mm<sup>2</sup>, rated temperature 90°C)</li> </ul>
Transmission cable supply current <sup>*2</sup>	Using 1.25 mm <sup>2</sup> cable: Max. 2 A Using 0.75 mm <sup>2</sup> cable: Max. 1 A
Maximum number of modules specification	Counts as 1 module
Number of occupied I/O points	32 points (I/O assignment: 32 intelligent points)
External power supply	Voltage: 21.6...27.6 V DC (24 V DC -10...+15%), ripple voltage 0.5 Vp-p or less Recommended voltage: 26.4 V DC (24 V DC +10%) Module current consumption: 0.1 A Transmission cable current supply: Max. 2 A <sup>*1</sup>
5 V DC internal current consumption	Max. 0.2 A
Weight	0.2 kg

\*1: With the slave module having an integrated transmission cable (DP, DN) and module, the length of the transmission cable (DP, DN) is included in the overall length.

\*2: Refer to the manual for the relation of the overall length, transmission cable (DP, DN) wire diameter and transmission cable current supply. In some slave modules with cables, the wire diameter of the transmission cable (DP, DN) integrated with the module may be 0.75 mm<sup>2</sup> or less.

Increase productivity and lower the total cost of ownership

# GX Works2

GX Works2 focuses on driving down total cost by including features that speed up commissioning, reduce downtime, improve programming productivity, and provide strong security.

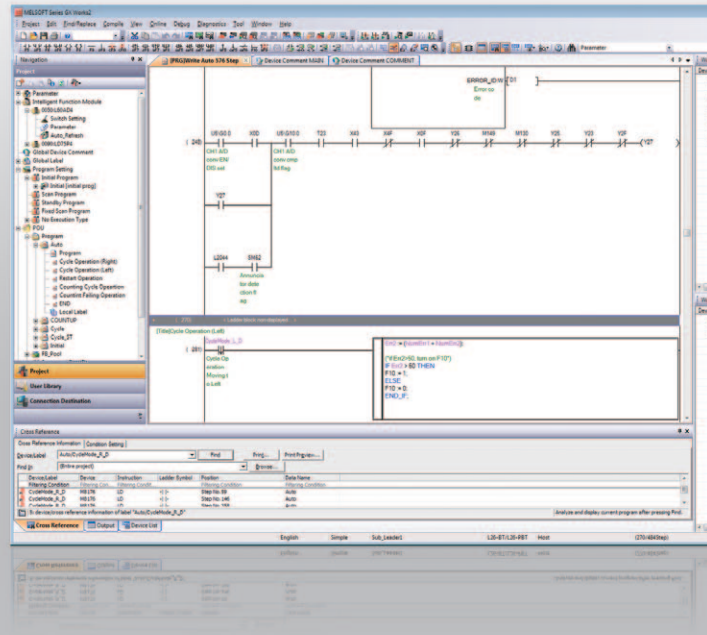

## User interface that is "easy to use" by design

The programming tool GX Works2 has been developed from the ground up to be intuitive for all users and allow anyone to begin programming easily. The user interface and other functions provide a comfortable programming environment that enables improvements in design efficiency.

Fully integrated intelligent function module management tools.

Use tabs to easily switch between programs, parameters, and other screens.

Improve readability by hiding ladder rungs not relevant to the current operation.

Use "Watch windows" to conveniently monitor pertinent values.

Project tree gives compressive look at flow of information in program and structure.

Program titles help to identify the content of each program.

Cross reference devices and labels with ease.

Use the Inline-ST\*1 feature to quickly write complex expressions in ladder programs.

Device/Label	Device	Instruction	Ladder Symbol	Position	Data Name
Filtering Condition	M8176	LD		Step No. 39	Auto
CycleMode_R_D	M8176	LD		Step No. 39	Auto
CycleMode_R_D	M8176	LD		Step No. 39	Auto
CycleMode_R_D	M8176	LD		Step No. 39	Auto

\*1: In-line ST can be only be created in projects that use labels.

## Easily create circuits with few key inputs

The program can be easily modified using the keyboard shortcut [ Alt ] + [ ← ] / [ → ] or [ Alt ] + [ ↑ ] / [ ↓ ] keys.

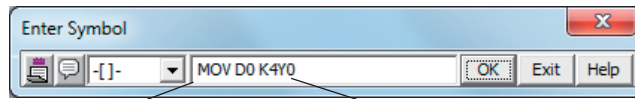

■ Editing the circuit  
[Alt]+[→] ... MOV→D0→K4Y0  
[Alt]+[←] ... K4Y0→D0→MOV



■ Changing the device No.  
[Alt]+[↑] ... K4Y0→K4Y1→K4Y2  
[Alt]+[↓] ... K4Y2→K4Y1→K4Y0

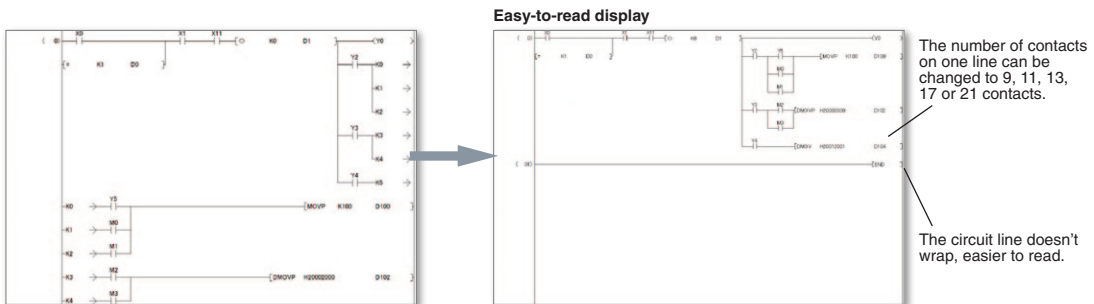

Click the Undo button.

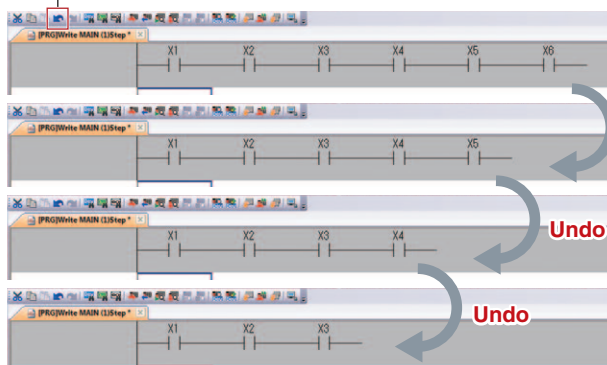

**Undo**  
Use Undo ([Ctrl] + [z]) to go back to up to 30 previous input steps.

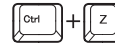

The device number is automatically incremented when repeatedly pasting a cut/copied ladder rung.

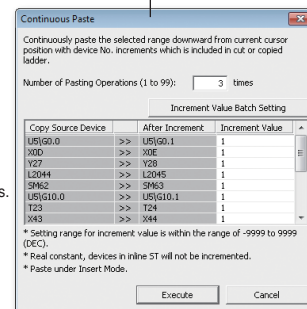

## Efficiently edit lines with keyboard

Ladder rungs can be easily modified just by using the various keyboard shortcut keys, eliminating the need to switch to editing mode.

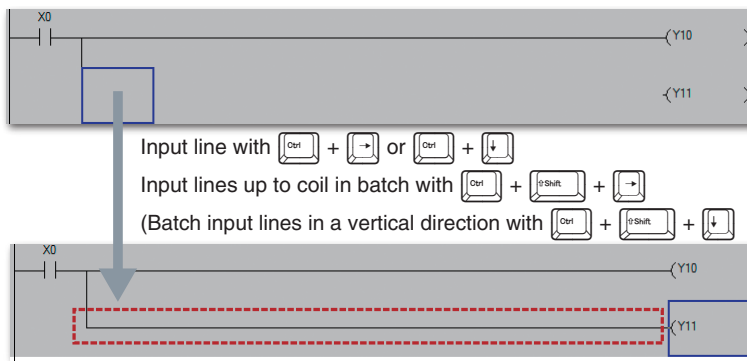

### Use function blocks for common operations

Function blocks allow selections of commonly used code to be easily reused and shared among projects. Shared or created function blocks can be added to a program using simple drag and drop operation. Using function blocks effectively results in faster development times with fewer programming mistakes.

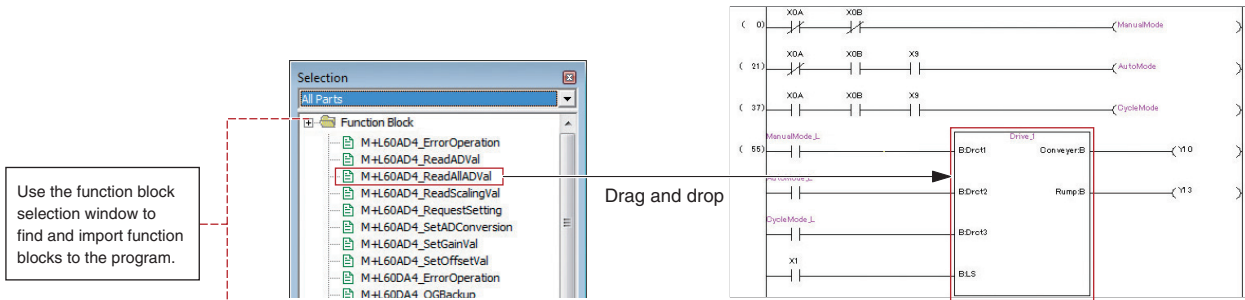

### Use sample comments to eliminate the need to input comments

Sample comments are provided for the CPU's special relays/registers and the intelligent function module's buffer memory/XY signals. These can be copied into the project's comments thus greatly reducing the time required for entering device comments.

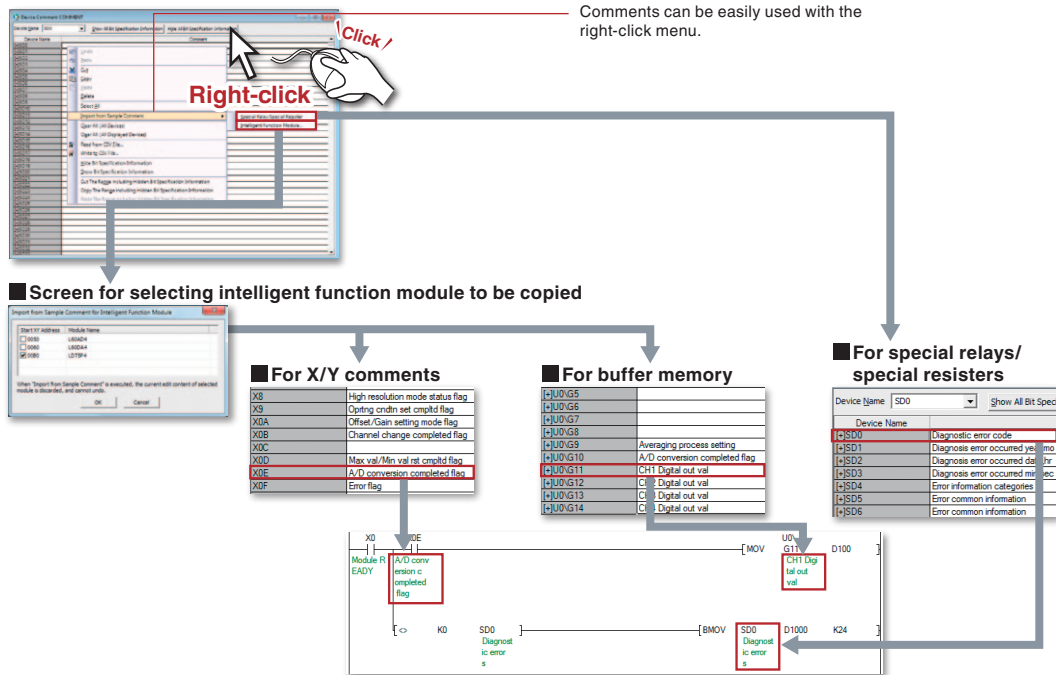

### Quickly identify similar devices

Word device comments can be registered per bit with the contents displayed directly on the ladder rung.

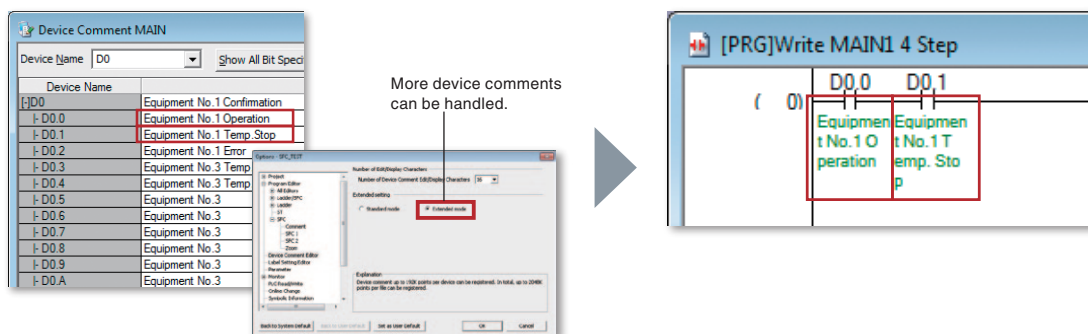

## Cross referencing interlinked with circuit displays

Relevant devices and labels can be searched within the contents of the program by using the cross reference tool. The results are immediately displayed in the cross reference dialog box conveniently besides the actual program view screen. It is then very easy to check where the relevant device is actually used within the program, just by double clicking on the target device.

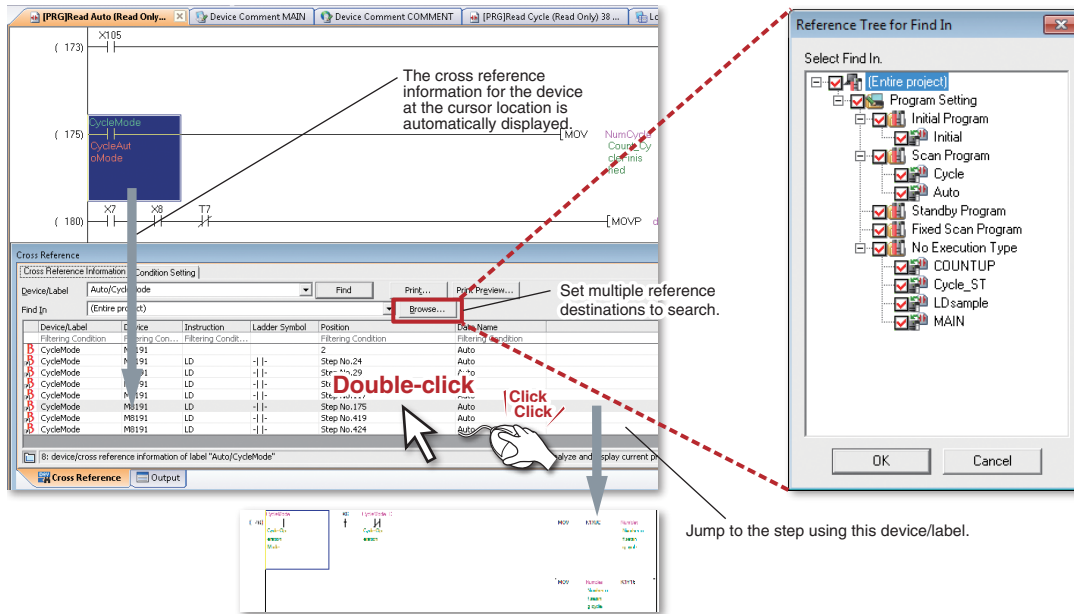

## Offline debug without physical hardware

**GX Simulator Function**

The simulation function is now integrated. The program can be executed in a step-by-step method, finding program errors more easily.

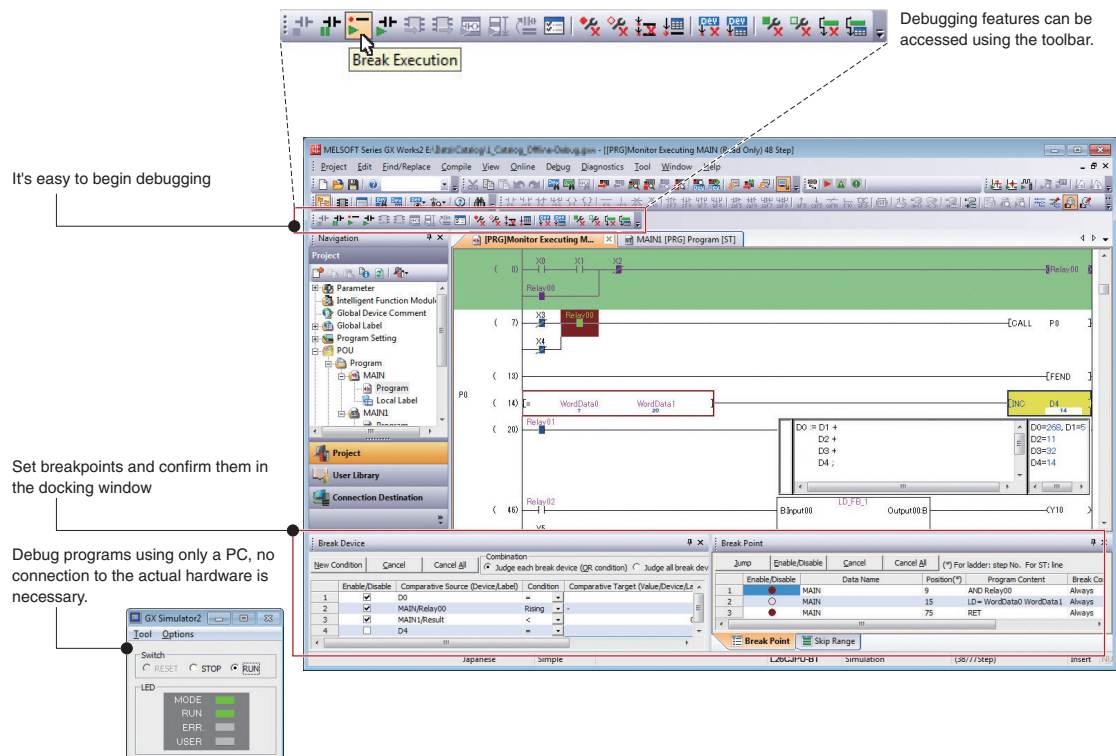

L Series Features  
CPU  
I/O  
Analog/Temperature Control  
Simple Motion/Positioning  
High-Speed Counter  
Network  
Digital Link Sensor  
Software  
Related Products

## Integrating the intelligent function module setting tool (GX Configurator)

The intelligent function module's setting functions have been unified with GX Works2. Manage the intelligent function module's setting with a GX Works2 project.

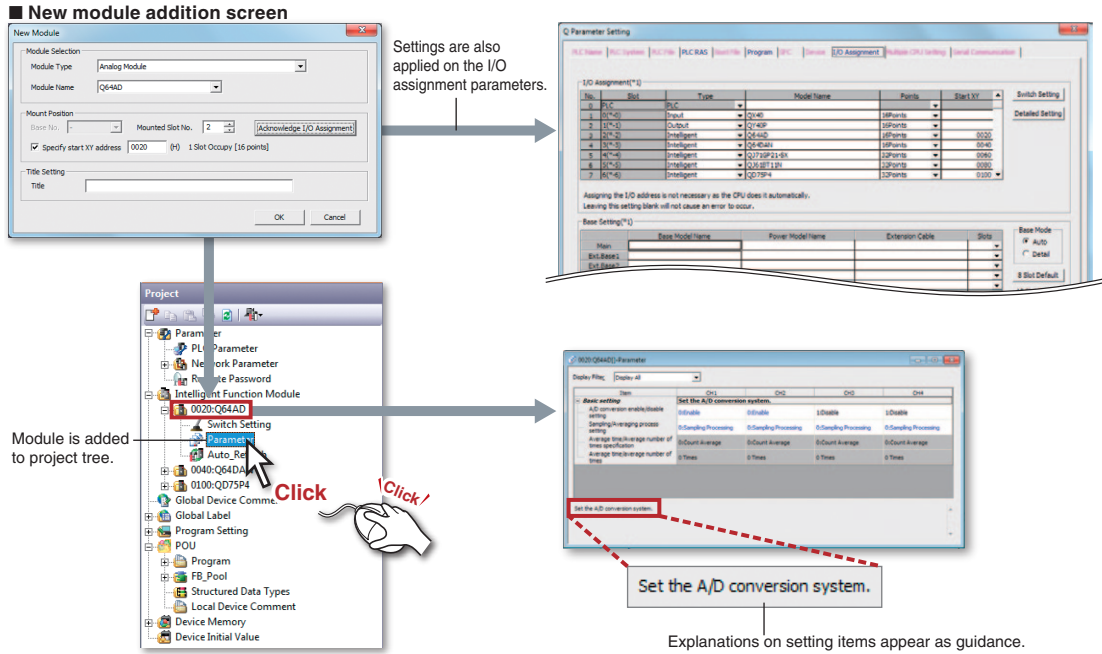

## Advanced PLC diagnostics

The diagnostics screen provides a wealth of information about the currently connected controller. The main screen allows the operational status of the entire programmable controller to be seen at a glance, allowing the immediate identification of problems. Additional detailed information is available to help with routine maintenance and problem resolution.

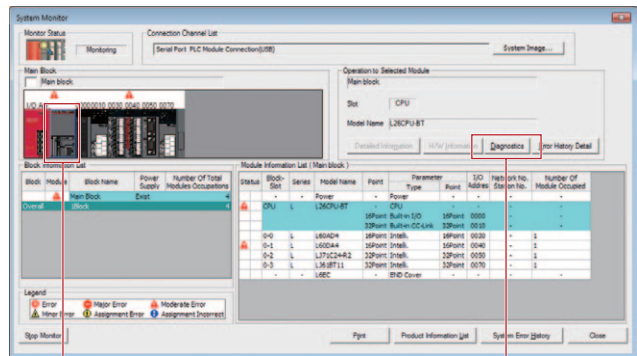

Jump to the module information screen | Jump to the PLC diagnostics screen

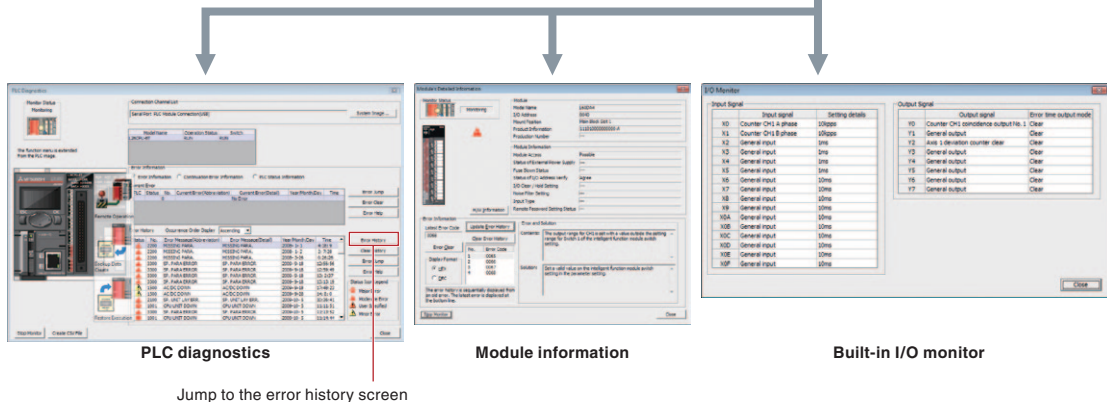



## Time-stamped error history list

Simplify troubleshooting with a combined, time-stamped, error history list for the CPU and all expansion modules. The details section provides explanations of error codes and suggested solutions.

No.	Error Code	Date and Time	Model Name	Start I/O
00060	5782	2009/10/08 18:14:17	LJ51ST11	0110
00059	7D13	2009/10/08 17:53:06	LJ71C24-R2	00F0
00058	7D16	2009/10/08 17:52:32	LJ71C24-R2	00F0
00057	05DC	2009/10/08 16:14:09	L26CPU-BT	----
00056	7D12	2009/10/08 16:00:53	LJ71C24-R2	00F0
00055	7D16	2009/10/08 15:50:24	LJ71C24-R2	00F0
00054	7D16	2009/10/08 14:43:27	LJ71C24-R2	00F0
00053	7D16	2009/10/08 14:35:03	LJ71C24-R2	00F0
00052	7D12	2009/10/08 14:35:02	LJ71C24-R2	00F0
00051	7D12	2009/10/08 14:35:53	LJ71C24-R2	00F0
00050	7FF2	2009/10/08 14:35:02	LJ71C24-R2	00F0
00049	1005	2009/10/08 14:03:44	L26CPU-BT	----
00048	7F42	2009/10/08 13:37:00	LJ71C24-R2	00F0
00047	0C21	2009/10/08 13:13:56	L26CPU-BT	----
00046	0834	2009/10/08 13:12:40	L26CPU-BT	----
00045	05DC	2009/10/08 13:11:51	L26CPU-BT	----
00044	7F42	2009/10/08 12:04:52	LJ71C24-R2	00F0
00043	0840	2009/10/08 11:43:17	L26CPU-BT	----
00042	0840	2009/10/08 11:43:17	L26CPU-BT	----

**Explanation**  
Station number specification error. The transmission destination and source stations were the same when other station connection was specified.

**Solution**  
Check the transmission destination station number, or change to host connection.

Quickly identify the error, its cause, and solution without the need to reference a manual.

## Set parameters and monitor the sensor

Parameter settings and monitoring can be performed on the third-party partner products, which support the iQ Sensor Solution (iQSS). Sensor connection and current values can be checked visually, allowing the user to act faster in case of a trouble.

**Right click**

Parameters can be set.

Statuses can be monitored.

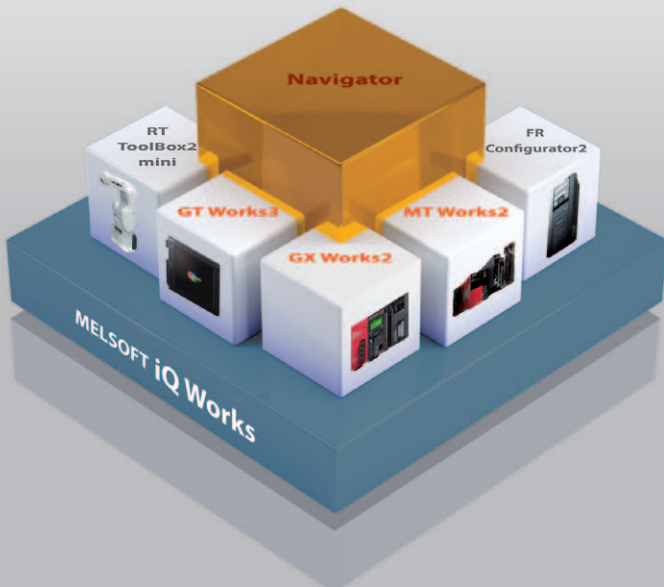

## MELSOFT iQ Works

MELSOFT iQ Works is an integrated software suite consisting of GX Works3, MT Works2, GT Works3, RT ToolBox2 mini and FR Configurator2, which are programming software for each respective product.

### Graphic-based project management

The entire control system is represented using the "Network Configuration" and "Module Configuration" windows.

System components are easily added using a drag & drop interface and the validity of the system can be confirmed using the check function to ensure parameters are configured correctly, the power supply is sufficient, etc.

Different project types can be grouped together (for example by factory, line, and cell) for central management.

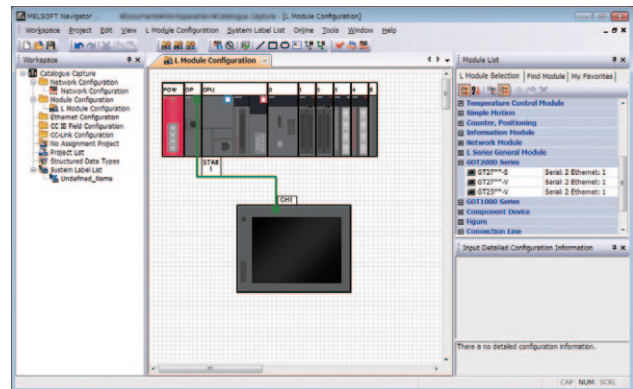

### Read project data for multiple devices in a batch

Multiple projects can be read as a block just by having one connection to the programmable controller. If there are multiple devices such as other CPU or GOT(HMI) on the same network as the target master programmable controller, it is possible to upload all projects to each target device without having to individually connect to each device.

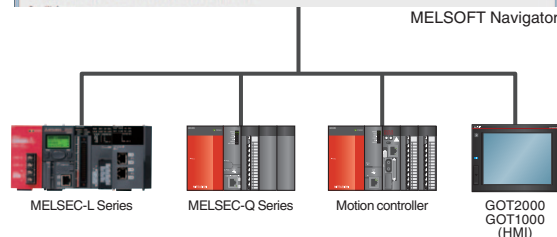
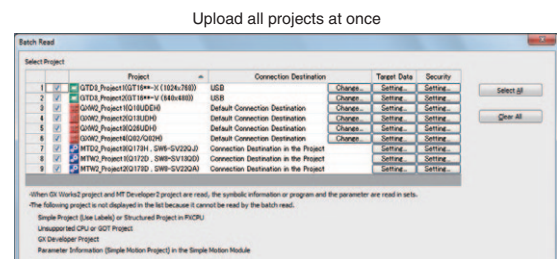

## Automatically startup the relevant maintenance software with a single click

Just click on the corresponding project in the system configuration diagram or workspace tree to automatically startup the software relevant for that device. Maintenance can be efficiently performed without having to know and startup each relevant software manually.

Click on corresponding project in workspace tree

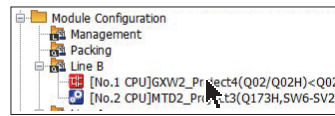

Click on corresponding device in system configuration diagram



Software for corresponding device automatically startup

GX Works2

MT Works2

GT Works3

RT ToolBox2

## Setup CC-Link slave stations

There's no need to prepare a dedicated tool to check or change the parameter settings for the CC-Link slave station on-site.

The latest version of iQ Works includes CC-Link slave station setting utility. Therefore, it is possible to directly confirm the inverter parameters or change the settings for changing the speed directly from the CC-Link configuration window, for example.

In addition, error information can also be read easily.



Right-click the slave station illustration and select the "slave station parameter process"

Directly open slave station's setting screen from CC-Link configuration window.

Slave station's parameter setting window opens

Set slave station parameters with GX Works2 and Navigator.

Get error information!

## Prepare a device from the system configuration diagram with no manual inputs

A list of modules used can be exported as a CSV file from the system configuration diagram.

This is particularly useful when utilizing data for creating a bill of materials (BOM) in Excel®, etc.

Export CSV file from list of modules

Create device list with Excel®

Print list of devices

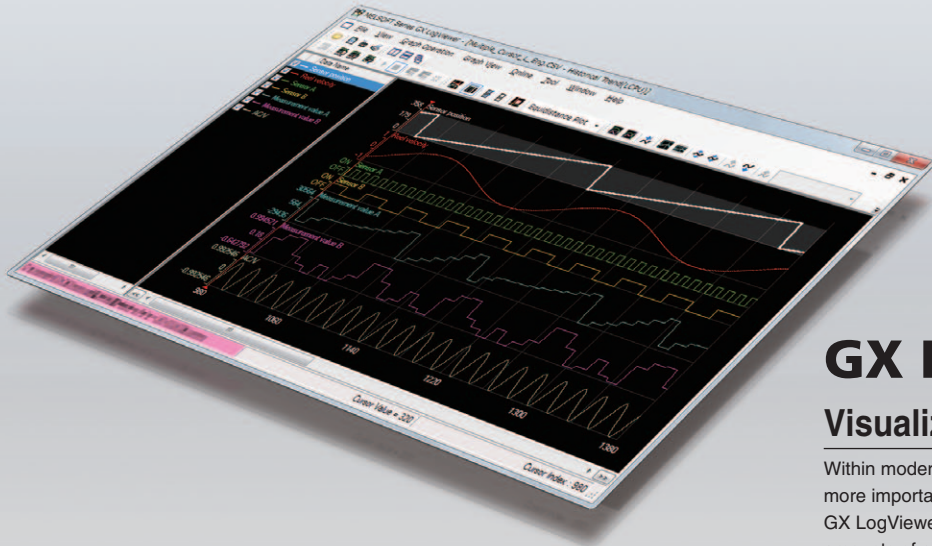

## GX LogViewer

### Visualizing the production process

Within modern manufacturing needs, data collection has become more important for fully optimizing the production process. GX LogViewer is a software tool that realizes visualization of large amounts of production data in a simple to use format. Utilizing this functionality to identify root error causes and improving the production rate.

### Easily display and analyze large amounts of collected logging data

This tool is used when large amounts of data need to be visualized and collected from the MELSEC-Q Series or MELSEC-L Series.

The connection settings and checking of log files are the same as GX Works2 enabling individual connections to each module.

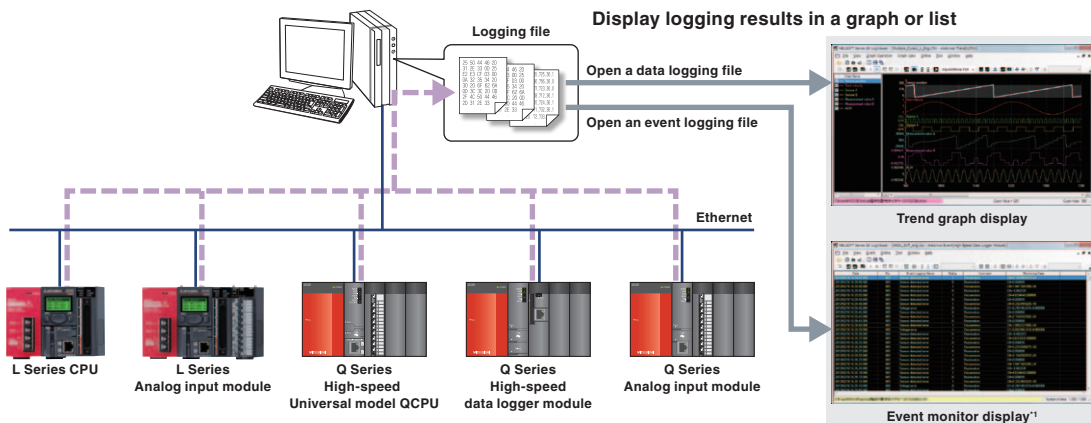

\*1: The event monitor display is supported only with the Q Series high-speed logger module.

### Easily adjust graphs without referring to the setup manual

#### Arranging graphs

Able to arrange each graph so as not to overlap each other. It is easier to display the graphs as each graph is evenly spaced out.

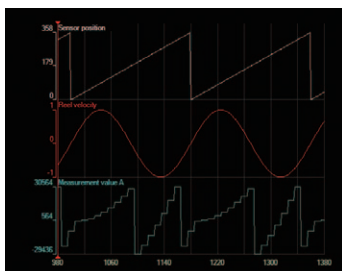

#### Overlapping graphs

With this it is possible to overlap each graph over one another. Multiple graphs can be compared enabling easier data analysis and comparison.

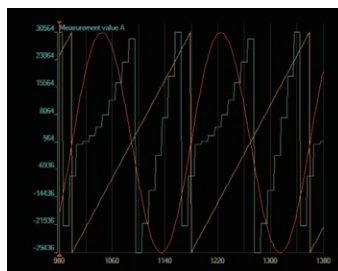

#### Automatically adjusting graphs

Various attributes of the graph are automatically adjusted (max/min values) as to display the upper and lower limit values better.

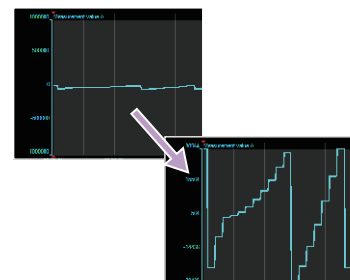

## Easily confirm changes in data with dual cursors

Data changes within a designated time frame can be quickly checked with user-friendly dual cursors (multi-cursors). When the cursors are moved to the point at which changes are to be confirmed, the difference in time and value between those points will appear.

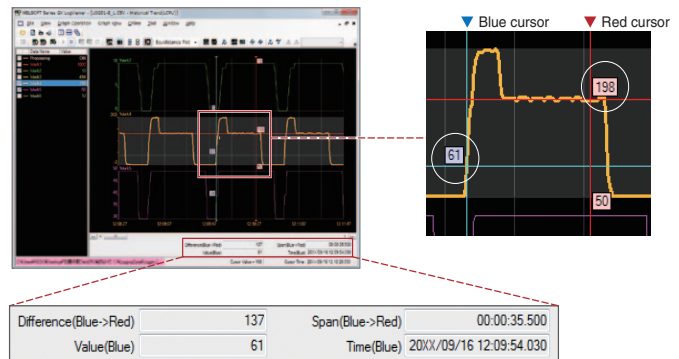

The difference in time and value between the cursors is automatically calculated and displayed.

## Display data for multiple files within one graph area for easy comparison

Data for multiple files are displayed with the same time units in the same graph area. The display position within a file can be moved easily. This allows the differences of data within multiple files to be confirmed easily.

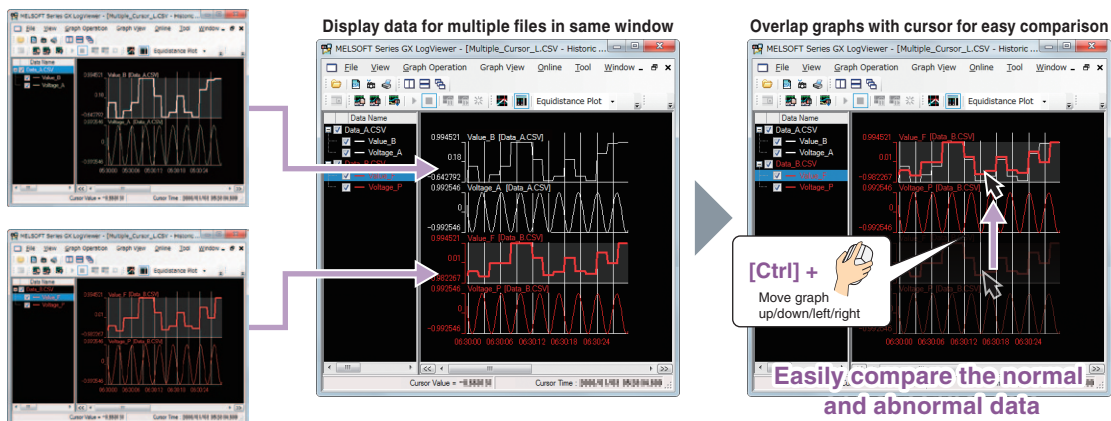

## Quickly jump cursor to designated position

### Cursor jump

Confirm data values by quickly moving the cursor to a designated value, time or index position in the trend graph.



**Jump Cursor**

Select conditions for jump cursor.

File Name: HSD\_L\_L.csv  
Data Name: Data5  
Classification: Conditional

Search the selecting data in specified condition.

Value Range: 0 to 4294967295

Select a cursor that jumps

Red Cursor  Blue Cursor

Jump Previous Jump Next Close

**Value search**  
Values are searched, and the cursor jumps to the position where the conditions match.

**Jump Cursor**

Select conditions for jump cursor.

File Name: HSD\_L\_L.csv  
Time Range: 2011/03/31 11:46:43 to 2011/03/31 11:48:22  
Date and time to which the cursor jumps

Date  
 Hour  Minute  Second

11 47 33

Select a cursor that jumps

Red Cursor  Blue Cursor

Jump Previous Jump Next Close

**Time designation**  
The cursor jumps to the designated time.

**Jump Cursor**

Select conditions for jump cursor.

File Name: HSD\_L\_L.csv  
Index Range: 1 to 100  
Index to which the cursor jumps: 51

Select a cursor that jumps

Red Cursor  Blue Cursor

Jump Previous Jump Next Close

**Index designation**  
The cursor jumps to the designated index.



# A tool for connecting! Visualizing! For a more seamless sensor control!

Sensors used on the manufacturing floor are becoming more intelligent and complex, requiring even more maintenance of equipment and the overall management of various configuration setup software. With iQSS, the intelligent sensor solution provided by Mitsubishi Electric, configuration and maintenance of sensors are further simplified with the connectivity to other components such as automation controllers, HMIs, and engineering software even further enhanced reducing the overall TCO\*.

\* Total Cost of Ownership



## iQ Sensor Solution

**iQSS** connects everything from general to advanced sensors.

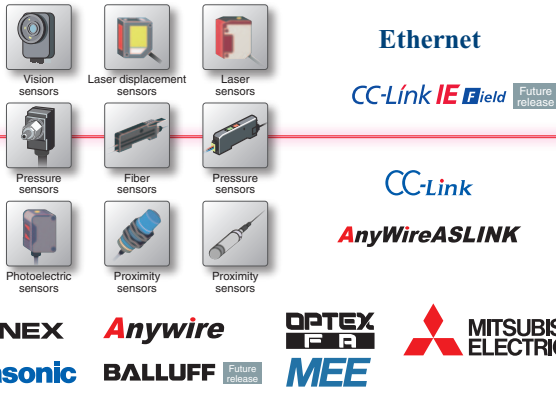

### System design

To manage projects simply, we provide a workspace tree that enables projects to be managed in a single location, and a system configuration chart that depicts the entire system graphically.

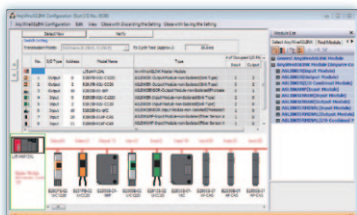

System configuration management

### Implementation

Functions are provided that allow monitoring from a single screen based on the system configuration chart so that the causes of problems can be identified quickly. This also shortens the time taken to adjust sections involving multiple devices.



Monitoring

### Programming

The labels used by PLCs can also be used by HMIs and sensors. This takes all the bother out of label setting. GOT sample screen libraries, sample ladders and function blocks, etc. are supported.

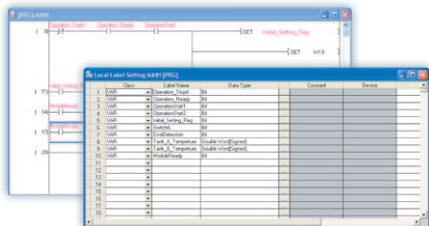

Label programming



### Operation & maintenance

To make backups less laborious, batch read/write functions are provided for PLC, HMI and sensor settings.

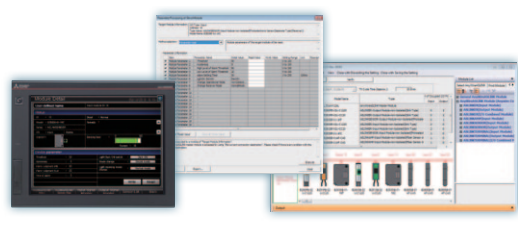

Sensor configuration read/write

Further simplifying the management of sensors in the control system



## Vision Solution

# COGNEX® machine vision system and Mitsubishi Electric FA Devices Innovating your production with this integral power.

Functioning as devices that “watch” instead of human eyes, COGNEX machine vision systems have continued to reform automation of production lines. Mitsubishi Electric FA devices, such as programmable controllers, lead the future of automation.

The possibilities of vision system solutions, created in the integration of this spirit of innovation, have continued to increase.



L(NA)08230E

For further details, please refer to the "Vision System & Factory Automation Solution Catalog".

### COGNEX In-Sight EZ Series iQSS ready! Device partner

- Entry model ..... **EZ-700**
- Standard model ..... **EZ-720**
- High-speed processing model ..... **EZ-740**
- High resolution model ..... **EZ-742**

#### Simple connection

##### Directly connect with Ethernet

The “In-Sight EZ” can be directly connected to the Ethernet port provided on the “MELSEC-Q Series universal model” and “MELSEC-L” programmable controller, and to the Ethernet module on the MELSEC-F. By using a switching hub, a multi-unit vision system having units installed as far as 100 m away can be created.

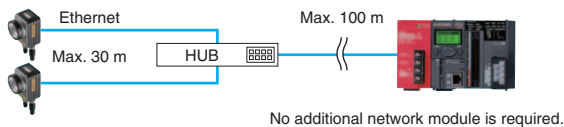

#### Simple communication with SLMP

Now that “In-Sight EZ” supports SLMP, data can be easily written from the vision system to the programmable controller. Communication is easily configured with “EasyBuilder”. Just select the connected device and SLMP, set the programmable controller device used for communication and select the communication data from the list. With the SLMP scanner mode, a trigger can be applied on the vision system via SLMP.

#### Simple control with function blocks (FB)

Intuitively setup the vision control system from the GX Works2 programming tool utilizing dedicated vision function blocks without having to develop specific programming code.

### COGNEX DataMan® Barcode Reader Device partner

- Fixed DataMan ..... **DataMan 50/60/300**
- Hand-held DataMan ..... **DataMan 8050/8100/8500**

#### DataMan - active in various industries

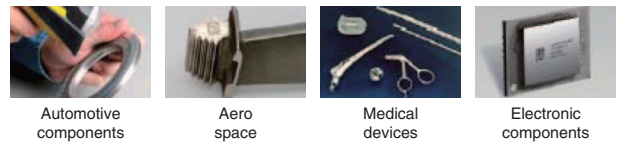

##### ●Fixed DataMan 50/60

- ▶ Unmatched read rate performance with Hotbars™
- ▶ Proprietary Hotbars™ technology
- ▶ Solid state design with no moving parts
- ▶ Easy setup with three position adjustable lens and integrated lighting aimer
- ▶ IP65-rated housing (DataMan 50)
- ▶ Supports SLMP (DataMan 60)

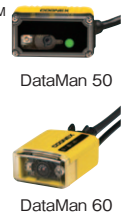

##### ●Fixed DataMan 300 Series

- ▶ Unprecedented read rate with Hotbars™
- ▶ Reads the most difficult-to-read 2-D Direct Part Mark (DPM) codes
- ▶ Liquid lens with automatic variable focus
- ▶ Intelligent tuning
- ▶ Integrated lighting module
- ▶ Supports SLMP

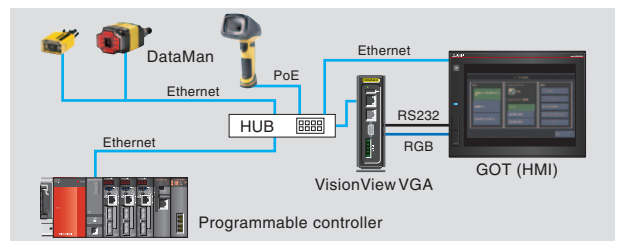

##### ●Hand-held DataMan 8050/8100/8500 Series

- ▶ UltraLight®: Two types of lighting enable optimum reading\*1
- ▶ Newly developed body enhances sturdiness
- ▶ Standard automatic focus adjustment function\*2
- ▶ Supports SLMP
- ▶ Cordless capability (up to 30 m communication range)
- ▶ Unprecedented read rate with Hotbars™



\*1: DataMan 8500

\*2: DataMan 8100 and 8500



**GOT2000**  
Graphic Operation Terminal

HMI

# Combination with GOT for all scenes from startup to maintenance

The GOT2000 boasts advanced functionality, acts as a seamless gateway to other industrial automation devices, all while increasing productivity and efficiency.

The high quality display is designed to optimize operator control and monitoring of device and line statuses. If you are looking for an intuitive operation terminal, the new tablet-like operability and the higher functionality of operation terminal makes the GOT2000 the ideal choice.

Incorporate the GOT2000 to bring forth flexibility, productivity, and quality on a global scale.

For further details, please refer to the "Mitsubishi Graphic Operation Terminal GOT2000 Series Catalog".



L(NA)08270ENG

## Graphic Operation Terminal

GOT2000 series/GOT1000 series

### Ladder programs can easily be edited on the GOT

#### Sequence Program Monitor (Ladder Editor)..... GT27/GT25/GT16/GT15

Sequence programs can be edited in a circuit diagram (ladder format). To quickly change contacts in an emergency, sequence programs can be edited in ladder format without using a personal computer.

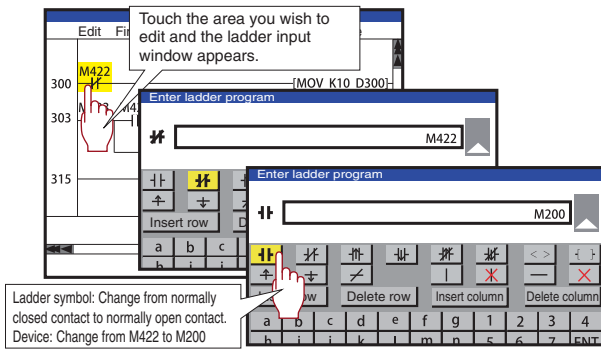

\* Supported by XGA / SVGA / VGA models excluding the 5.7-inch type.  
\* Process CPUs, redundant CPUs are not supported.

### Program debugging can be performed without opening the control panel

#### FA Transparent..... All models

Connected with a PC, the GOT acts as a transparent gateway to enable programming, start up, and adjustment of equipment using GX Works2 or GX LogViewer. Users do not have to bother with opening the control panel or changing cable connections.

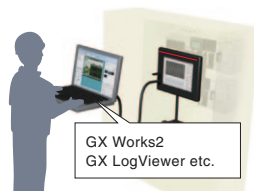

(On the GT23, GT21, or GT10 Series, the FA transparent function can be used via the interface on the rear side.)

### Programmable Controller can be recovered promptly in case of emergency

#### Backup/Restore..... GT27/GT25/GT23/GT21/GT16/GT15/GT14/GT12

Sequence programs and parameters can be backed up to the memory card or USB memory in the GOT. Users can perform batch operation to restore the data to the PLC CPU or motion controller. Make a data backup in case of a problem such as a dead battery in a PLC CPU to quickly replace the faulty device and restore the system without using a personal computer.

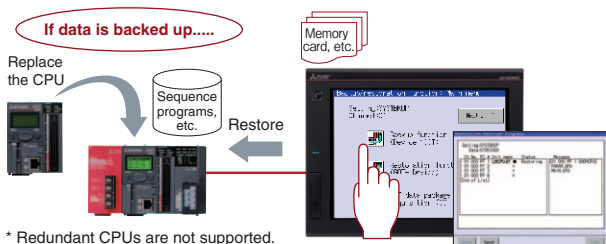

### View logging data without a PC

#### Log Viewer..... GT27/GT25/GT16

Logging data can be confirmed with the GOT even if a PC is not available on-site, allowing problems to be troubleshooted quickly. Changes in the data can be quickly confirmed with the dual cursors (multi-cursors) that are displayed similar to GX LogViewer.

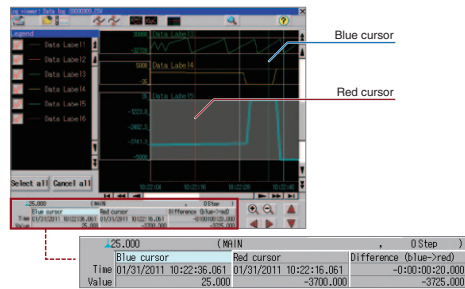

### Logging data can be collected without opening the control panel

#### Log Viewer..... GT27/GT25/GT16

In a USB memory device attached to the USB interface on the front of the GOT, the logging data can be saved. The logging data can easily be collected without removing the SD card from the CPU inside of the control panel.

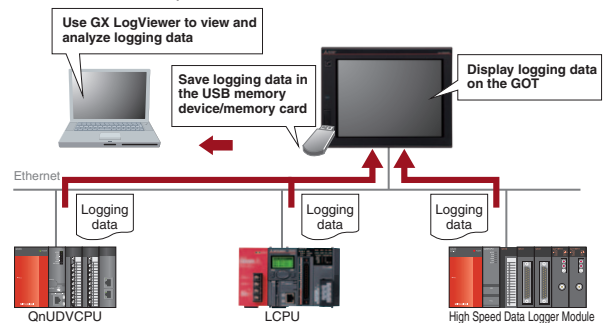

### Various functions of GOT support your maintenance work

#### MELSEC-L Troubleshooting..... GT27/GT25/GT16

Just one touch to jump to the functions such as the intelligent module monitor to quickly perform troubleshooting at the worksite.

#### Dedicated MELSEC-L Series maintenance screen

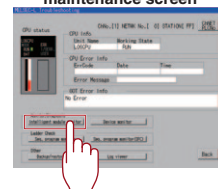

Jump from the L Series maintenance screen to the intelligent module monitor screen







AC Servo

# Man, machine and environment in perfect harmony

## MELSERVO-J4 — trusted technology makes an evolutionary leap forward.

Introducing the MELSERVO-J4 series. Offering more than just improved performance, these servos are designed to drive the industries of tomorrow. Backed by Mitsubishi leadership in all-digital technology, MELSERVO has become one of the most globally respected names in factory automation. And now — with the safety, ease of use, and energy-efficient design of the new MELSERVO-J4 series — man, machine and environment can at last work together in perfect harmony.

For further details, please refer to the "MELSERVO-J4" catalog.



L(NA)03058

MITSUBISHI SERVO AMPLIFIERS & MOTORS

# MELSERVO-J4



L Series Features

CPU

I/O

Analog/  
Temperature  
Control

Simple Motion/  
Positioning

High-Speed  
Counter

Network

Digital Link  
Sensor

Software

Related Products



## Machine

### The leading edge in drive control

- Industry-leading level of basic performance
- High-resolution absolute position encoder
- Advanced one-touch tuning
- Advanced vibration suppression control II
- Robust filter

#### [Advanced one-touch tuning]

Servo gains including vibration suppression control and robust filter are adjusted just by turning on the one-touch tuning function. Machine performance is utilized to the fullest using the advanced vibration suppression control function.

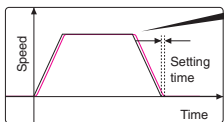

Exactly matched.  
High-speed positioning



## Man

### Safety and convenience

- Equipped with the safety observation function (IEC/EN 61800-5-2)
- Tough drive function
- Large capacity drive recorder
- Machine diagnosis function
- MR Configurator2

#### [Large capacity drive recorder]

Servo data (motor current, etc.) before and after the alarm occurrence are stored in non-volatile memory. Waveforms can be checked in graph. This enables quick and accurate identification of the cause of the alarm.

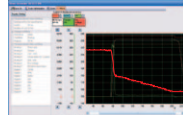

## The Environment

### Eco-friendly design that's winning acclaim worldwide

- Multi-axis servo amplifier
- Power monitor function
- Compatible with power regeneration common converter
- Energy-conservation achieved by improved performance

#### [Power monitor function]

Power consumption is calculated from the data in the servo amplifier such as speed and current, and then displayed, enabling energy-conserving system examination.

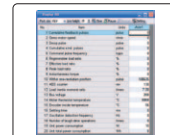

## Lineup

### Servo Amplifiers



**MR-J4-B**  
SSCNET III/H compatible servo amplifier

**MR-J4W2-B**  
SSCNET III/H compatible 2-axis servo amplifier

**MR-J4W3-B**  
SSCNET III/H compatible 3-axis servo amplifier

With the SSCNET III/H compatible servo amplifier, a synchronous system can be configured using high-speed serial optical communication. Servo system performance and functions are utilized to the fullest when the servo amplifier is combined with the servo system controller.



**MR-J4-B-RJ010 + MR-J3-T10**  
CC-Link IE Field Network servo amplifier with Motion

The CC-Link IE Field Network interface servo amplifier with Motion is compatible with the Motion control in the Ethernet-based open network.



**MR-J4-A**  
General-purpose interface compatible servo amplifier

The general-purpose interface compatible servo amplifier enables position control by pulse train command and speed/torque control by analog voltage command.

### Servo Motors

#### Rotary servo motor

Small capacity, low inertia  
**HG-KR Series**  
Capacity: 50 to 750 W

Small capacity, ultra-low inertia  
**HG-MR Series**  
Capacity: 50 to 750 W

Medium capacity, medium inertia  
**HG-SR Series**  
Capacity: 0.5 to 7 kW

Medium/large capacity, low inertia  
**HG-JR Series**  
Capacity: 0.5 to 55 kW

Medium capacity, ultra-low inertia  
**HG-RR Series**  
Capacity: 1 to 5 kW

Medium capacity, flat type  
**HG-UR Series**  
Capacity: 0.75 to 5 kW

#### Linear servo motor

Core type  
**LM-H3 Series**  
Rating: 70 to 960 N

Core type with magnetic attraction counter-force  
**LM-K2 Series**  
Rating: 120 to 2400 N

Core type (natural/liquid cooling)  
**LM-F Series**  
Rating: 300 to 3000 N (natural cooling)  
Rating: 600 to 6000 N (liquid cooling)

Coreless type  
**LM-U2 Series**  
Rating: 50 to 800 N

#### Direct drive motor



**TM-RFM Series**  
Rating: 2 to 240 N·m

# Achieving higher drive performance and energy conservation with inverters

The inverter is a variable frequency power device that can easily and freely change the speed of a 3-phase induction motor.

The Mitsubishi inverter is high-performance and environment-conscious, and complies with global standards.

Select a model from our diverse lineup to match your needs.

## Inverter



## Answering various needs with the best choices Frequency Inverter

### Inverter

- FR800 Series ..... A800, F800
- FR700 Series ..... E700, F700PJ, D700

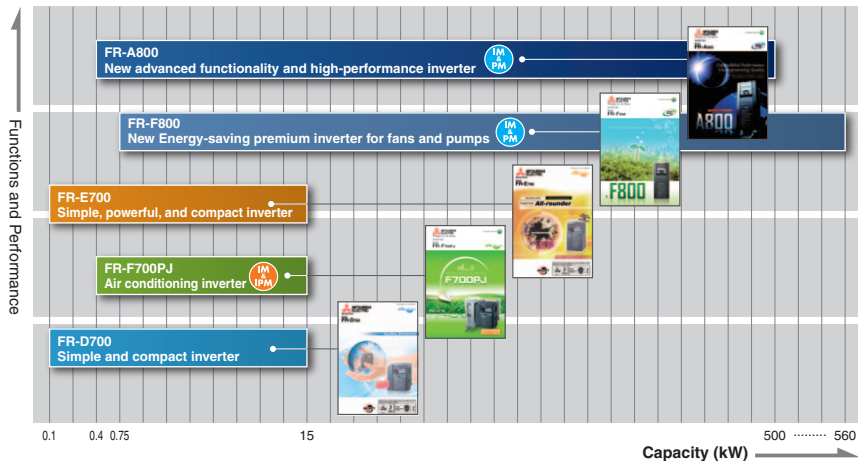

### Control inverter with CC-Link communication

The inverter can be controlled to a programmable controller with CC-Link.<sup>\*1</sup>

This function is supported with CC-Link Ver. 1.1 and Ver. 2.0.

The inverter can be operated and monitored, and the parameters set from the programmable controller.

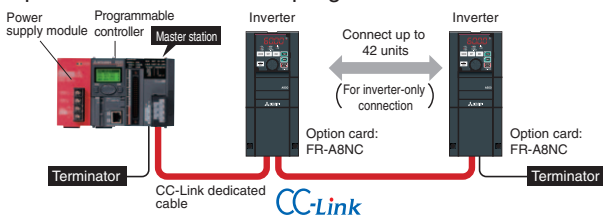

\*1: The inverter option card (FR-A8NC) is required.  
Please refer to the relevant catalog for additional information.

### Easy synchronous operation with SSCNET III connection

Connect to a motion controller with SSCNET III<sup>\*2</sup>. SSCNET III uses the high-speed synchronous serial communication method (high-speed, high-accuracy, high-reliability optical communication), and is perfect for synchronous operation.

(SSCNET: Servo System Controller Network)

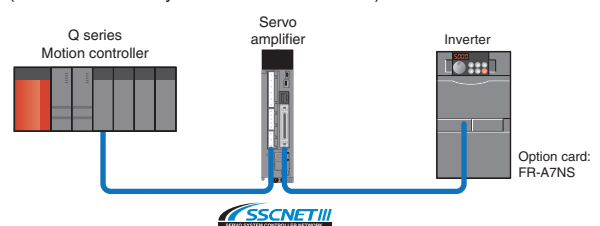

\*2: The inverter option card (FR-A7NS) is required.



## Contactors and Motor Starters

# Diverse variations to respond to all situations

The Mitsubishi Electric Contactors and Motor Starters MS-T and MS-N series and DC interface contactor SD-Q series products are equipped with an environment and global compliance, compact size, ease-of-use and safety. Certification to various international standards, this highly reliable magnetic contactor is suitable for a variety of applications from panels to systems.

For further details, please refer to the "Magnetic Motor Starters and Contactors MS-T/N series Catalog".



L(NA)02030



L(NA)74109218

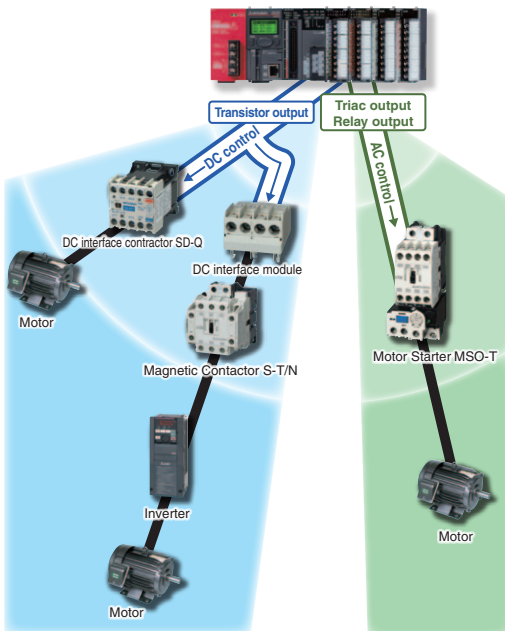

## Direct drive with Programmable Controller

The SD-Q Series has a small coil VA and can be driven by the programmable controller without adding an amplifying relay. By adding the DC interface module, the MS-T/N Series can be used with a wide range of motor capacities.

		Programmable controller output module type		
		Transistor output	Contact output	Triac output
DC interface contactor SD-Q Series	DC operation	●	●	—
Magnetic contactor MS-T Series	AC operation (Using DC interface module)	●	●	●
Magnetic contactor MS-N Series	AC operation (Using DC interface module)	●	●	●
	DC operation	△	—	—

\*: This table shows the relation of the programmable controller output module type and operation interface. There may be restrictions according to the type of frame size, etc., that can be used. Refer to the MS-T/N Series Catalog, or contact a Mitsubishi dealer or Sales Office for details on the types of magnetic switches and models that can be used.

## SD-Q series

Direct drive is possible with the programmable controller's transistor output. Since a relay and interface module are not required, the number of parts can be reduced, and space can be saved.

### Standard surge absorber

Prevent adverse effects onto the peripheral equipment.

### Standard terminal cover

A terminal cover with finger protection function is installed as a standard.

This cover answers to user's needs for safety.

## MS-T series (10A to 32A)

Mitsubishi Electric's main series is equipped with a small size, ease-of-use, safety and international compliance. This series greatly contributes to smaller panels, easier selection and compliance with international standards.

### 10A frame model is just 36 mm wide!!

The industry's smallest width has been realized for the general-purpose magnetic contactor. The other rated products have also been downsized to help you reduce your panel size.

\*: 10A frame general-purpose magnetic contactor (Mitsubishi Electric survey as of Oct. 2014)

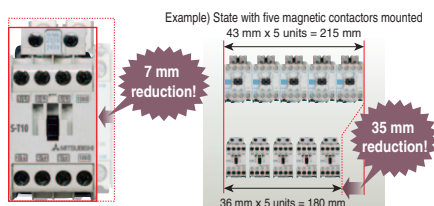

### Wide range of operation coil ratings!!

The wider operation coil rating ranges allow us to consolidate the number of coil types from 14 types (N Series) to 7 types.

This helps reduce stock and makes it easier to select the required type.

### Standard terminal cover!!

The standard terminal cover improves the safety in the panel, and simplifies ordering as a separate model no longer needs to be specified.

CPU modules

L02SCPU, L02SCPU-P

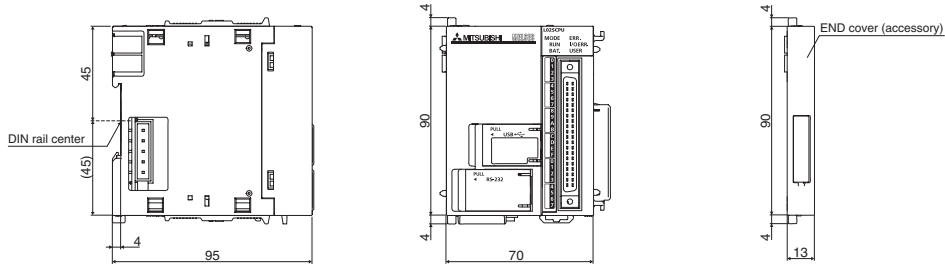

L02CPU, L02CPU-P, L06CPU, L06CPU-P, L26CPU, L26CPU-P

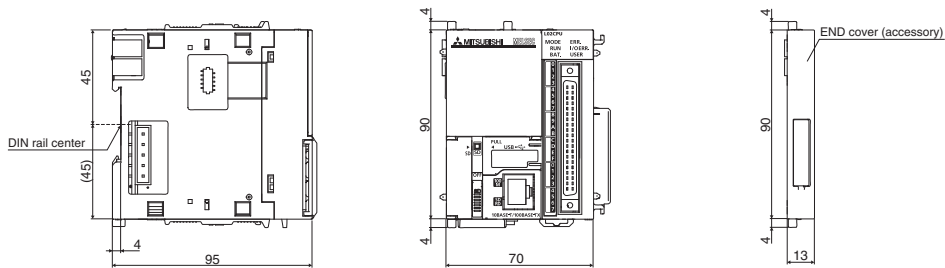

L26CPU-BT, L26CPU-PBT

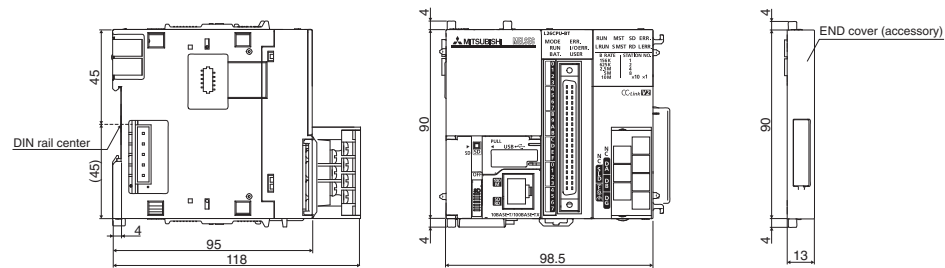

Display unit

L6DSPU

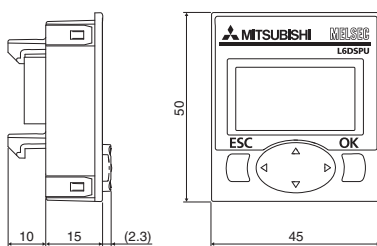

RS-232 adapter

L6ADP-R2

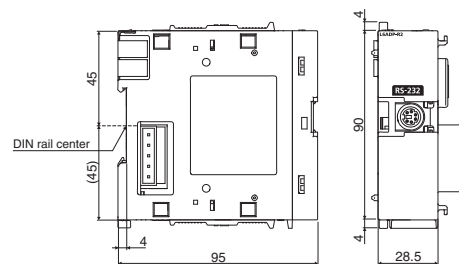

Unit: mm

## RS-422/485 adapter

L6ADP-R4

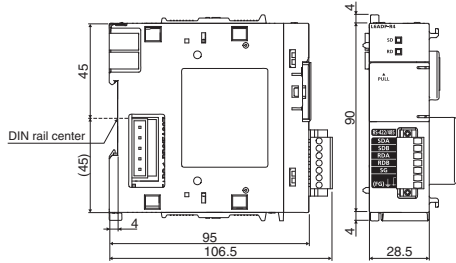

## END cover with error terminal

L6EC-ET

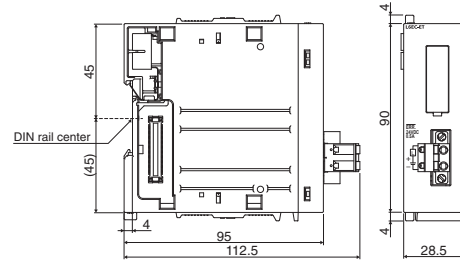

## Power supply modules

L61P, L63P

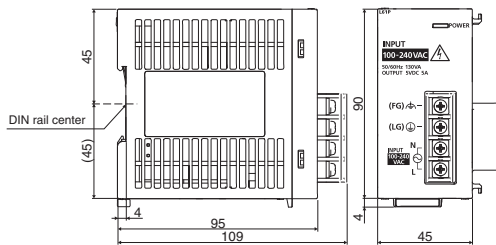

L63SP

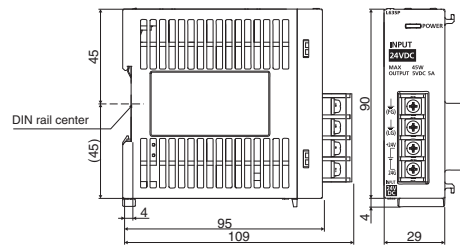

## Branch module

L6EXB

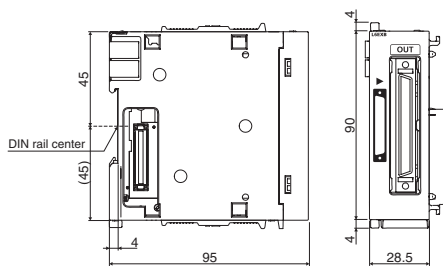

## Extension module

L6EXE

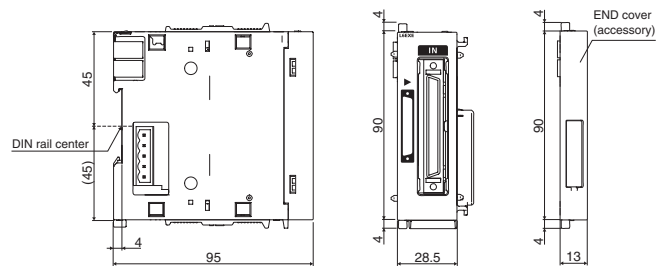

## Extension cable

LC06E, LC10E, LC30E

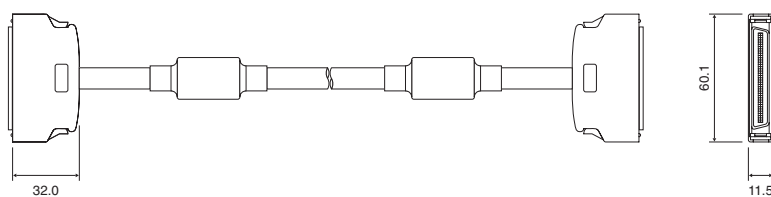

Unit: mm

**Input/Output/I/O combined modules**

LX10, LX28, LX40C6, LY10R2, LY18R2A **NEW**  
 LY20S6, LY28S1A **NEW**, LY40NT5P, LY40PT5P

LX41C4, LY41NT1P, LY41PT1P

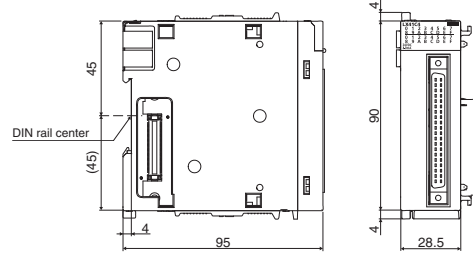
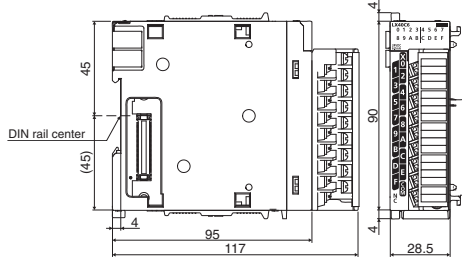

LX42C4, LY42NT1P, LY42PT1P  
 LH42C4NT1P, LH42C4PT1P

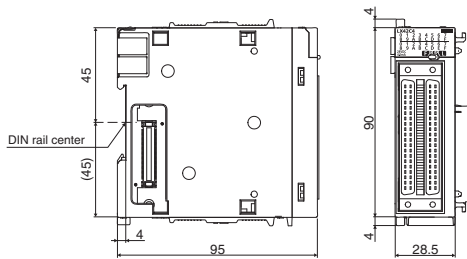

LG69 **NEW**

L6TE-18S **NEW**

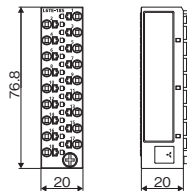
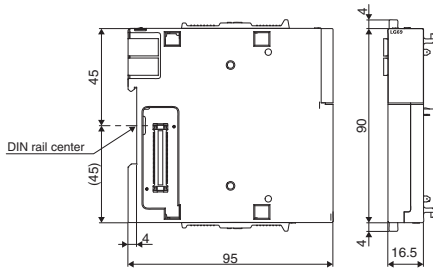

**Multiple input (voltage/current/temperature)/Analog input/output/I/O module**

L60MD4-G **NEW**, L60AD4, L60DA4, L60ADVL8 **NEW**, L60ADIL8 **NEW**, L60AD4-2GH, L60AD2DA2

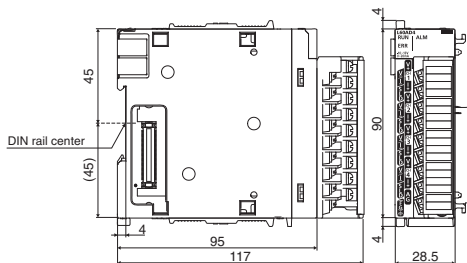

Unit: mm

Temperature control modules

L60TCTT4, L60TCRT4

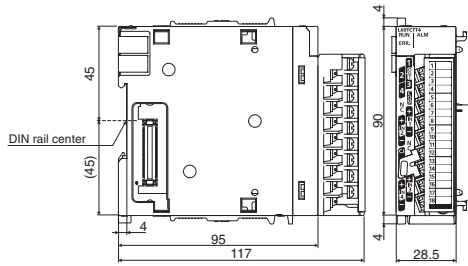

L60TCTT4BW, L60TCRT4BW

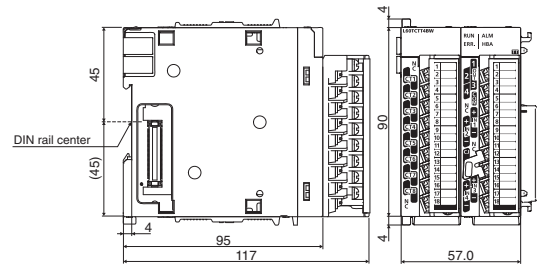

Simple motion module

LD77MS2, LD77MS4, LD77MS16,  
LD77MH4, LD77MH16

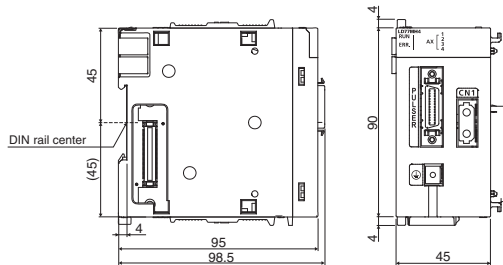

Positioning modules

LD75P1, LD75P2

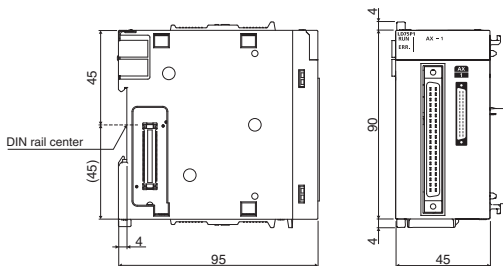

LD75D1, LD75D2

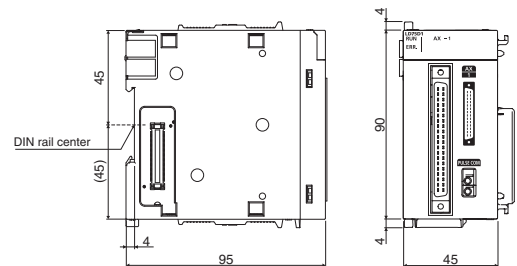

LD75P4

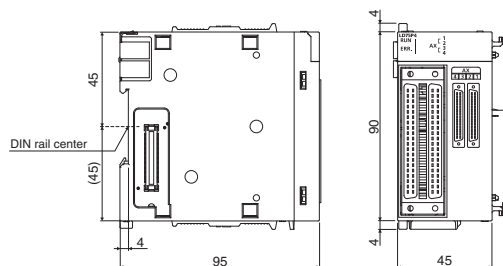

LD75D4

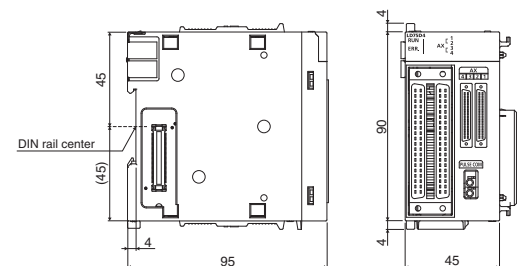

Unit: mm

High-speed counter module

LD62, LD62D

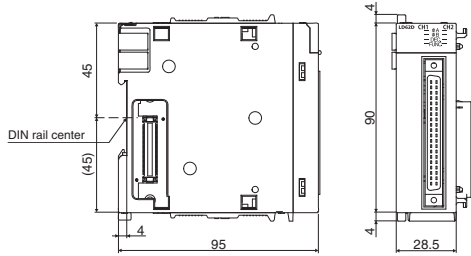

CC-Link IE Field Network master/local module

LJ71GF11-T2

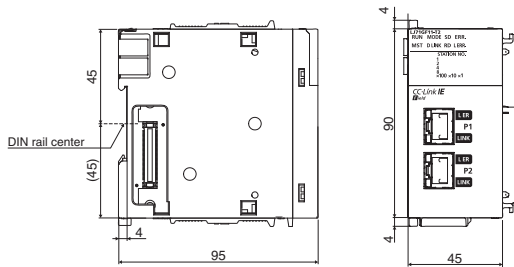

CC-Link IE Field Network head module

LJ72GF15-T2

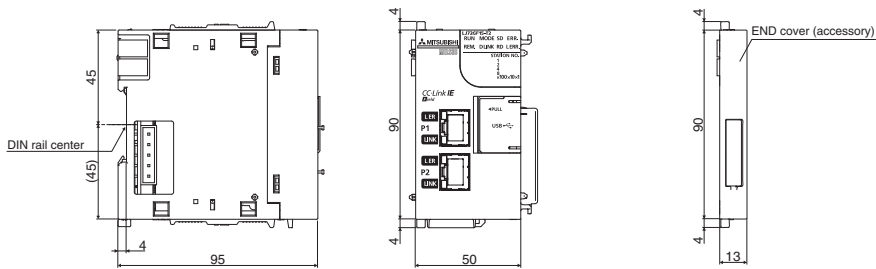

CC-Link master/local module

LJ61BT11

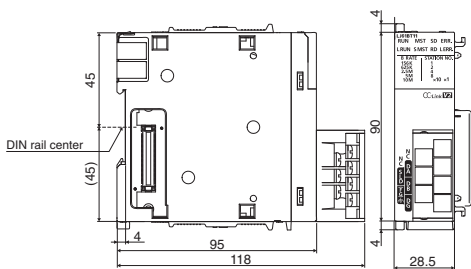

CC-Link/LT master module

LJ61CL12

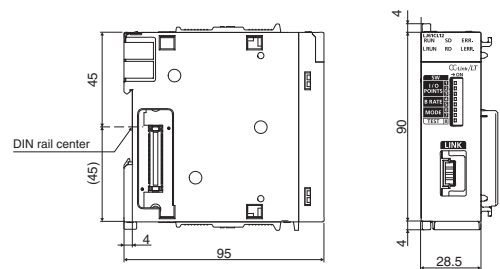

Unit: mm



### SSCNET III/H head module

LJ72MS15

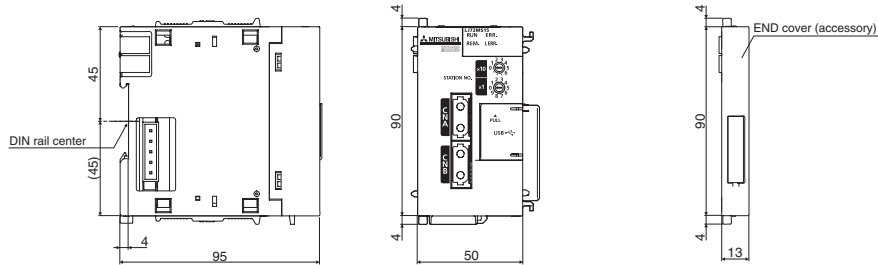

### Ethernet interface module

LJ71E71-100

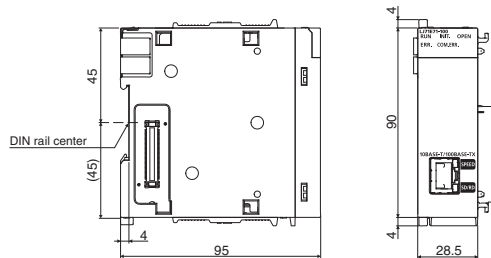

### Serial communication modules

LJ71C24

LJ71C24-R2

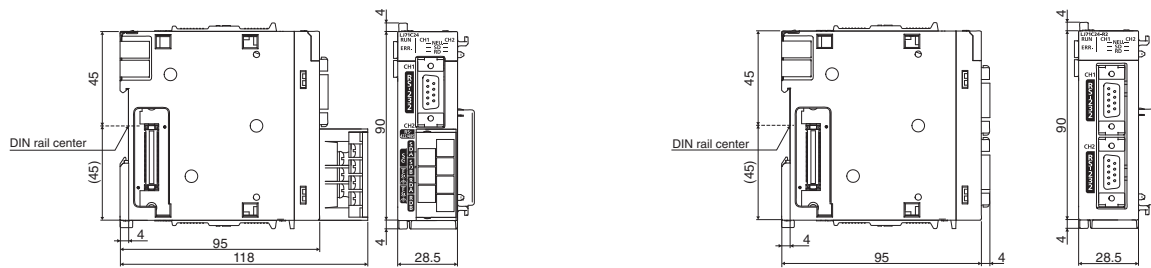

### AnyWireASLINK master module

LJ51AW12AL DB

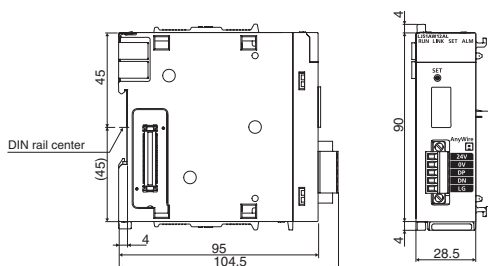

Unit: mm

# Extensive global support coverage providing expert

## Global FA centers

Mitsubishi Electric Global FA centers have been established in various countries around the world to cover the Americas, Europe and Asia. FA centers help to ensure compliance with the certifications and regulations of different regions, initiate product development in response to local demands and provide full-time, professional customer service.



**Germany FA Center**  
**MITSUBISHI ELECTRIC EUROPE B.V. German Branch**  
 Gothaer Strasse 8, D-40880 Ratingen, Germany  
 Tel: +49-2102-486-0 / Fax: +49-2102-486-1120  
 Area covered: Mainly Western Europe



**Russia FA Center**  
**MITSUBISHI ELECTRIC EUROPE B.V. Russian Branch St. Petersburg office**  
 Piskarevsky pr. 2, bld. 2, lit "Sch", BC "Benua", office 720, 195027, St. Petersburg, Russia  
 Tel: +7-812-633-3497 / Fax: +7-812-633-3499  
 Area covered: Russia



**Taichung FA Center**  
**MITSUBISHI ELECTRIC TAIWAN CO., LTD.**  
 No.8-1, Industrial 16th Road, Taichung Industrial Park, Taichung City 40768, Taiwan, R.O.C.  
 Tel: +886-4-2359-0688 / Fax: +886-4-2359-0689  
 Area covered: Taiwan



**UK FA Center**  
**MITSUBISHI ELECTRIC EUROPE B.V. UK Branch**  
 Travellers Lane, Hatfield, Hertfordshire, AL10 8XB, U.K.  
 Tel: +44-1707-28-8780 / Fax: +44-1707-27-8695  
 Area covered: UK, Ireland



**Czech Republic FA Center**  
**MITSUBISHI ELECTRIC EUROPE B.V. Czech Branch**  
 Avenir Business Park, Radlicka 751/113e, 158 00 Praha5, Czech Republic  
 Tel: +420-251-551-470 / Fax: +420-251-551-471  
 Area covered: Czech, Slovakia



**Europe FA Center**  
**MITSUBISHI ELECTRIC EUROPE B.V. Polish Branch**  
 ul. Krakowska 50, 32-083 Balice, Poland  
 Tel: +48-12-630-47-00 / Fax: +48-12-630-47-01  
 Area covered: Central and Eastern Europe



**Turkey FA Center**  
**MITSUBISHI ELECTRIC TURKEY A.Ş Ümraniye Branch**  
 Serifali Mahallesi Nutuk Sokak No:5, TR-34775 Ümraniye, Istanbul, Turkey  
 Tel: +90-216-526-3990 / Fax: +90-216-526-3995  
 Area covered: Turkey



**ASEAN FA Center**  
**MITSUBISHI ELECTRIC ASIA PTE. LTD.**  
 307, Alexandra Road, Mitsubishi Electric Building, Singapore 159943  
 Tel: +65-6470-2480 / Fax: +65-6476-7439  
 Area covered: Southeast Asia



**Indonesia FA Center**  
**PT. MITSUBISHI ELECTRIC INDONESIA Cikarang Office**  
 Jl. Kenari Raya Blok G2-07A Delta Silicon 5, Lippo Cikarang-Bekasi 17550, Indonesia  
 Tel: +62-21-2961-7797 / Fax: +62-21-2961-7794  
 Area covered: Indonesia

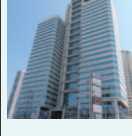

**Thailand FA Center**  
**MITSUBISHI ELECTRIC FACTORY AUTOMATION (THAILAND) CO., LTD.**  
 12th Floor, SV/City Building, Office Tower 1, No. 896/19 and 20 Rama 3 Road, Kwaeng Bangpangpang, Khet Yannawa, Bangkok 10120, Thailand  
 Tel: +66-2682-6522 / Fax: +66-2682-6020  
 Area covered: Thailand

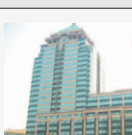

**Beijing FA Center**  
**MITSUBISHI ELECTRIC AUTOMATION (CHINA) LTD. Beijing Branch**  
 Unit 901, 9F, Office Tower 1, Henderson Centre, 18 Jianguomennei Avenue, Dongcheng District, Beijing, China  
 Tel: +86-10-6518-8830 / Fax: +86-10-6518-2938  
 Area covered: China



**Tianjin FA Center**  
**MITSUBISHI ELECTRIC AUTOMATION (CHINA) LTD. Tianjin Branch**  
 Room 2003 City Tower, No.35, Youyi Road, Hexi District, Tianjin, China  
 Tel: +86-22-2813-1015 / Fax: +86-22-2813-1017  
 Area covered: China



**Guangzhou FA Center**  
**MITSUBISHI ELECTRIC AUTOMATION (CHINA) LTD. Guangzhou Branch**  
 Room 1609, North Tower, The Hub Center, No. 1068, Xingang East Road, Haizhu District, Guangzhou, China  
 Tel: +86-20-8923-6730 / Fax: +86-20-8923-6715  
 Area covered: China

## China (including Hong Kong area)

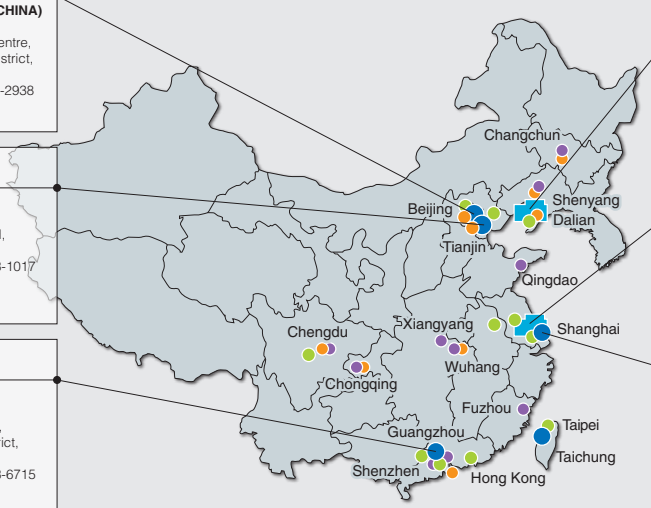

**Local factory in China**  
**Mitsubishi Electric Dalian Industrial Products Co., Ltd.**

**Local factory in China**  
**Mitsubishi Electric Automation Manufacturing (Changshu) Co., Ltd.**  
 No.706 Southeast Building, Chengahu Southeast Economic Development Zone of Jiangsu, 215500 China  
 Tel: +86-512-5213-3077 / Fax: +86-512-5213-3088

**Shanghai FA Center**  
**MITSUBISHI ELECTRIC AUTOMATION (CHINA) LTD.**  
 No.1386 Hongqiao Road, Mitsubishi Electric Automation Center, Shanghai, China  
 Tel: +86-21-2322-3030 / Fax: +86-21-2322-3000  
 Area covered: China



# help whenever needed.

- FA center
- FA center satellite (China)
- Mechatronics service center (China)
- Sales and Service office
- Factory location
- ◆ Development center

**Taipei FA Center**

**SETSUYO ENTERPRISE CO., LTD.**  
3F, No. 105, Wugong 3rd Road, Wugu District, New Taipei City 24889, Taiwan, R.O.C.  
Tel: +886-2-2299-9917 / Fax: +886-2-2299-9963  
Area covered: Taiwan

**Korea FA Center**

**mitsubishi electric automation korea CO., LTD.**  
7F-9F, Gangseo Hangang Xi-tower A, 401, Yangcheon-ro, Gangseo-Gu, Seoul 157-801, Korea  
Tel: +82-2-3660-9605 / Fax: +82-2-3663-0475  
Area covered: Korea

**North America FA Center**

**MITSUBISHI ELECTRIC AUTOMATION, INC.**  
500 Corporate Woods Parkway, Vernon Hills, IL 60061, U.S.A.  
Tel: +1-847-478-2469 / Fax: +1-847-478-2253  
Area covered: North America, Chile, Brazil

**Mexico FA Center**

**MITSUBISHI ELECTRIC AUTOMATION, INC. Mexico Branch**  
Mariano Escobedo #69, Col. Zona Industrial, Tlalpanpantla Edo, C.P.54030, Mexico  
Tel: +52-55-3067-7511  
Area covered: Mexico

**Hanoi FA Center**

**MITSUBISHI ELECTRIC VIETNAM COMPANY LIMITED Hanoi Branch**  
6-Floor, Detech Tower, 8 Ton That Thuyet Street, My Dinh 2 Ward, Nam Tu Liem District, Hanoi, Vietnam  
Tel: +84-4-3937-8075 / Fax: +84-4-3937-8076  
Area covered: Vietnam

**Ho Chi Minh FA Center**

**MITSUBISHI ELECTRIC VIETNAM COMPANY LIMITED**  
Unit 01-04, 10th Floor, Vincom Center, 72 Le Thanh Ton Street, District 1, Ho Chi Minh City, Vietnam  
Tel: +84-8-3910-5945 / Fax: +84-8-3910-5947  
Area covered: Vietnam

**Brazil Boituva FA Center**

**MELCO C&C DO BRASIL COMERCIO E SERVIÇOS S.A.**  
Acesso Jose Sartorelli, KM 2.1 CEP 18550-000 Boituva-SP, Brasil  
Tel: +55-15-3363-9900 / Fax: +55-15-3363-9911  
Area covered: Brazil

**Brazil FA Center**

**MITSUBISHI ELECTRIC DO BRASIL COMERCIO E SERVIÇOS LTDA.**  
Rua Jussara, 1750-Bloco B Anexo, Jardim Santa Cecilia, CEP 06465-070, Barueri-SP, Brasil  
Tel: +55-11-4689-3000 / Fax: +55-11-4689-3016  
Area covered: Brazil

## India

**India Gurgaon FA Center**

**MITSUBISHI ELECTRIC INDIA PVT. LTD. Gurgaon Head Office**  
2nd Floor, Tower A & B, Cyber Greens, DLF Cyber City, DLF Phase-III, Gurgaon-122002 Haryana, India  
Tel: +91-124-463-0300 / Fax: +91-124-463-0399  
Area covered: India

**India Chennai FA Center**

**MITSUBISHI ELECTRIC INDIA PVT. LTD. Chennai Branch**  
"Citilights Corporate Centre" No.1, Vivekananda Road, Srinivasa Nagar, Chetpet, Chennai-600031, Tamil Nadu, India  
Tel: +91-44-4554-8772 / Fax: +91-44-4554-8773  
Area covered: India

**India Pune FA Center**

**MITSUBISHI ELECTRIC INDIA PVT. LTD. Pune Branch**  
Emerald House, EL-3, J Block, M.I.D.C Bhosari, Pune-411026, Maharashtra, India  
Tel: +91-20-2710-2000 / Fax: +91-20-2710-2100  
Area covered: India

**India Ahmedabad FA Center**

**MITSUBISHI ELECTRIC INDIA PVT. LTD. Ahmedabad Branch**  
B/4, 3rd Floor, Safal Profitaire, Corporate Road, Prahaladnagar, Satellite, Ahmedabad, Gujarat-380015, India  
Tel: +91-79-6512-0063 / Fax: +91-79-6512-0063  
Area covered: India

**India Bangalore FA Center**

**MITSUBISHI ELECTRIC INDIA PVT. LTD. Bangalore Branch**  
Prestige Emerald, 6th Floor, Municipal No. 2, Madras Bank Road (Lavelle Road), Bangalore-560001, Karnataka, India  
Tel: +91-80-4020-1600 / Fax: +91-80-4020-1699  
Area covered: India

# Product List

Please refer to the product user manuals for information about compatible modules, restrictions, etc., before using the products.  
Please visit the Mitsubishi Electric FA site or contact your nearest branch for the latest information on the MELSOFT versions and compatible OS.

[ Legend ] **DB** : Double brand product <sup>(Note)</sup> **NEW** : Recently released product **SOON** : Product available soon

## MELSEC-L series

Type		Model	Outline
CPU		L02SCPU	Number of I/O points: 1024 points, Number of I/O device points: 8192 points, Program capacity: 20K steps, Basic operation processing speed (LD instruction): 60 ns, Program memory capacity: 80 KB, Peripheral connection ports: USB and RS-232 (Predefined protocol support function), Memory card I/F: None, Built-in I/O functions (General-purpose input: 16 points, General purpose output (Sink type): 8 points, Interrupt input, Pulse catch, Positioning, High-speed counter), END cover included
		L02SCPU-P	Number of I/O points: 1024 points, Number of I/O device points: 8192 points, Program capacity: 20K steps, Basic operation processing speed (LD instruction): 60 ns, Program memory capacity: 80 KB, Peripheral connection ports: USB and RS-232 (Predefined protocol support function), Memory card I/F: None, Built-in I/O functions (General-purpose input: 16 points, General-purpose output (Source type): 8 points, Interrupt input, Pulse catch, Positioning, High-speed counter), END cover included
		L02CPU	Number of I/O points: 1024 points, Number of I/O device points: 8192 points, Program capacity: 20K steps, Basic operation processing speed (LD instruction): 40 ns, Program memory capacity: 80 KB, Peripheral connection ports: USB and Ethernet (Predefined protocol support function), Memory card I/F: SD Memory Card, Built-in I/O functions (General-purpose input: 16 points, General-purpose output (Sink type): 8 points, Interrupt input, Pulse catch, Positioning, High-speed counter), END cover included
		L02CPU-P	Number of I/O points: 1024 points, Number of I/O device points: 8192 points, Program capacity: 20K steps, Basic operation processing speed (LD instruction): 40 ns, Program memory capacity: 80 KB, Peripheral connection ports: USB and Ethernet (Predefined protocol support function), Memory card I/F: SD Memory Card, Built-in I/O functions (General-purpose input: 16 points, General-purpose output (Source type): 8 points, Interrupt input, Pulse catch, Positioning, High-speed counter), END cover included
		L06CPU	Number of I/O points: 4096 points, Number of I/O device points: 8192 points, Program capacity: 60K steps, Basic operation processing speed (LD instruction): 9.5 ns, Program memory capacity: 240 KB, Peripheral connection ports: USB and Ethernet (Predefined protocol support function), Memory card I/F: SD Memory Card, Built-in I/O functions (General-purpose input: 16 points, General-purpose output (Sink type): 8 points, Interrupt input, Pulse catch, Positioning, High-speed counter), END cover included
		L06CPU-P	Number of I/O points: 4096 points, Number of I/O device points: 8192 points, Program capacity: 60K steps, Basic operation processing speed (LD instruction): 9.5 ns, Program memory capacity: 240 KB, Peripheral connection ports: USB and Ethernet (Predefined protocol support function), Memory card I/F: SD Memory Card, Built-in I/O functions (General-purpose input: 16 points, General-purpose output (Sink type): 8 points, Interrupt input, Pulse catch, Positioning, High-speed counter), END cover included
		L26CPU	Number of I/O points: 4096 points, Number of I/O device points: 8192 points, Program capacity: 260K steps, Basic operation processing speed (LD instruction): 9.5 ns, Program memory capacity: 1040 KB, Peripheral connection ports: USB and Ethernet (Predefined protocol support function), Memory card I/F: SD Memory Card, Built-in I/O functions (General-purpose input: 16 points, General-purpose output (Sink type): 8 points, Interrupt input, Pulse catch, Positioning, High-speed counter), END cover included
		L26CPU-P	Number of I/O points: 4096 points, Number of I/O device points: 8192 points, Program capacity: 260K steps, Basic operation processing speed (LD instruction): 9.5 ns, Program memory capacity: 1040 KB, Peripheral connection ports: USB and Ethernet (Predefined protocol support function), Memory card I/F: SD Memory Card, Built-in I/O functions (General-purpose input: 16 points, General-purpose output (Source type): 8 points, Interrupt input, Pulse catch, Positioning, High-speed counter), END cover included
		L26CPU-BT	Number of I/O points: 4096 points, Number of I/O device points: 8192 points, Program capacity: 260K steps, Basic operation processing speed (LD instruction): 9.5 ns, Program memory capacity: 1040 KB, Peripheral connection ports: USB and Ethernet (Predefined protocol support function), Memory card I/F: SD Memory Card, Built-in I/O functions (General-purpose input: 16 points, General-purpose output (Sink type): 8 points, Interrupt input, Pulse catch, Positioning, High-speed counter), CC-Link master/local station function, END cover included
		L26CPU-PBT	Number of I/O points: 4096 points, Number of I/O device points: 8192 points, Program capacity: 260K steps, Basic operation processing speed (LD instruction): 9.5 ns, Program memory capacity: 1040 KB, Peripheral connection ports: USB and Ethernet (Predefined protocol support function), Memory card I/F: SD Memory Card, Built-in I/O functions (General-purpose input: 16 points, General-purpose output (Source type): 8 points, Interrupt input, Pulse catch, Positioning, High-speed counter), CC-Link master/local station function, END cover included
CPU packages		L02CPU-SET	CPU module (L02CPU), Display unit (L6DSPU), and Power supply module (L61P) set
		L02CPU-P-SET	CPU module (L02CPU-P), Display unit (L6DSPU), and Power supply module (L61P) set
		L06CPU-SET	CPU module (L06CPU), Display unit (L6DSPU), and Power supply module (L61P) set
		L06CPU-P-SET	CPU module (L06CPU-P), Display unit (L6DSPU), and Power supply module (L61P) set
		L26CPU-SET	CPU module (L26CPU), Display unit (L6DSPU), and Power supply module (L61P) set
		L26CPU-P-SET	CPU module (L26CPU-P), Display unit (L6DSPU), and Power supply module (L61P) set
		L26CPU-BT-SET	CPU module (L26CPU-BT), Display unit (L6DSPU), and Power supply module (L61P) set
		L26CPU-PBT-SET	CPU module (L26CPU-PBT), Display unit (L6DSPU), and Power supply module (L61P) set
CPU options	Display unit	L6DSPU	STN black-and-white LCD, 16 characters x4 lines
	Battery	Q6BAT	Replacement battery
		Q7BAT-SET	High capacity battery with a battery holder for CPU installation
		Q7BAT	High capacity replacement battery
	SD Memory Card	L1MEM-2GBSD*1	2GB SD Memory Card
		L1MEM-4GBSD*1	4GB SD Memory Card
	RS-232 adapter	L6ADP-R2	For GOT(HMI) connection, 1 x RS-232 channel, maximum transmission speed: 115.2Kbps, MELSOFT connectable MODBUS® RTU master function (using predefined protocol support function)
RS-422/485 adapter	L6ADP-R4	For GOT(HMI) connection, 1 x RS-422/485 channel, maximum transmission speed: 115.2Kbps MODBUS® RTU master function (using predefined protocol support function)	
END cover with error terminal		L6EC-ET	END cover with error terminal

\*1: Mitsubishi Electric does not guarantee the operation of non-Mitsubishi Electric products.

Note: General specifications and product guarantee conditions of jointly developed products are different from those of MELSEC products.  
For more information, please refer to the product manuals or contact your local Mitsubishi representative for details.

## MELSEC-L series

Type		Model	Outline	
Power supply		L61P	Input voltage: 100...240 V AC, Output voltage: 5 V DC, Output current: 5 A	
		L63P	Input voltage: 24 V DC, Output voltage: 5 V DC, Output current: 5 A	
	Slim type Power supply	L63SP	Input voltage: 24 V DC, Output voltage: 5 V DC, Output current: 5 A, No isolation	
Branch / Extension module		L6EXB	Branch module	
		L6EXE	Extension module with END cover	
	Extension cable	LC06E	0.6-m cable for connecting branch and extension modules	
		LC10E	1.0-m cable for connecting branch and extension modules	
		LC30E	3.0-m cable for connecting branch and extension modules	
I/O module	Input	AC input	LX10	16 points, 100...120 V AC, Response time: 20 ms or less, 16 points/common, 18-point terminal block
			LX28	8 points, 100...240 V AC, Response time: 20 ms or less, 8 points/common, 18-point terminal block
		DC input	LX40C6	16 points, 24 V DC, Response time: 1/5/10/20/70 ms or less, 16 points/common, Positive/Negative common, 18-point terminal block
			LX41C4	32 points, 24 V DC, Response time: 1/5/10/20/70 ms or less, 32 points/common, Positive/Negative common, 40-pin connector
			LX42C4	64 points, 24 V DC, Response time: 1/5/10/20/70 ms or less, 32 points/common, Positive/Negative common, 40-pin connector x2
		Output	Relay	LY10R2
	LY18R2A <b>NEW</b>			8 points, 24 V DC/240 V AC, 2 A/point, 8 A/module, Response time: 12 ms or less, No common (all points independent), 18-point terminal block
	Triac		LY20S6	16 points, 100...240 V AC, 0.6 A/point, 4.8 A/common, Response time: 1 ms + 0.5 cycles or less, 16 points/common, 18-point terminal block
			LY28S1A <b>NEW</b>	8 points, 100...240 V DC, 1 A/point, 8 A/module, Response time: 1 ms + 0.5 cycles or less, No common (all points independent), 18-point terminal block
	Transistor (Sink)		LY40NT5P	16 points, 12...24 V DC, 0.5 A/point, 5 A/common, Response time: 1 ms or less, 16 points/common, 18-point terminal block, overload protection function, overheat protection function, surge suppression
			LY41NT1P	32 points, 12...24 V DC, 0.1 A/point, 2 A/common, Response time: 1 ms or less, 32 points/common, Sink type, 40-pin connector, overload protection function, overheat protection function, surge suppression
			LY42NT1P	64 points, 12...24 V DC, 0.1 A/point, 2 A/common, Response time: 1 ms or less, 32 points/common, Sink type, 40-pin connector x2, overload protection function, overheat protection function, surge suppression
	Transistor (Source)		LY40PT5P	16 points, 12...24 V DC, 0.5 A/point, 5 A/common, Response time: 1 ms or less, 16 points/common, 18-point terminal block, overload protection function, overheat protection function, surge suppression
			LY41PT1P	32 points, 12...24 V DC, 0.1 A/point, 2 A/common, Response time: 1 ms or less, 32 points/common, 40-pin connector, overload protection function, overheat protection function, surge suppression
			LY42PT1P	64 points, 12...24 V DC, 0.1 A/point, 2 A/common, Response time: 1 ms or less, 32 points/common, 40-pin connector x2, overload protection function, overheat protection function, surge suppression
	I/O combined	DC input/transistor output (sink)	LH42C4NT1P	Input specifications : 32 points, 24 V DC, Response time: 1/5/10/20/70 ms or less, 32 points/common, Positive/Negative common Output specifications : 32 points, 12...24 V DC, 0.1 A/point, 2 A/common, Response time: 1 ms or less, 32 points/common, overload protection function, overheat protection function, surge suppression 40-pin connector x2
		DC input/transistor output (source)	LH42C4PT1P	Input specifications : 32 points, 24 V DC, Response time: 1/5/10/20/70 ms or less, 32 points/common, Positive/Negative common Output specifications : 32 points, 12...24 V DC, 0.1 A/point, 2 A/common, Response time: 1 ms or less, 32 points/common, overload protection function, overheat protection function, surge suppression 40-pin connector x2
	Space module		LG69 <b>NEW</b>	Space module for AnS module replacement
	Spring clamp terminal block		L6TE-18S <b>NEW</b>	Alternative to a 18-point screw terminal block, 0.3...1.0 mm <sup>2</sup> (AWG22...18), push-in type

## MELSEC-L series

Type		Model	Outline
Multiple input (voltage/current/temperature) modules		L60MD4-G <b>NEW</b>	4 channels, Input: -10...10 V DC, 0...20 mA DC, micro voltage-100...100 mV DC, Thermocouple (K, J, T, E, N, R, S, B, U, L, PL II, W5Re/W26Re), RTD (Pt1000, Pt100, JPt100, Pt50), Output (resolution): 0...20000, -20000...20000, (with voltage, current, micro voltage input) Conversion speed: 50 ms/channels, 18-point terminal block, Channel isolated
Analog I/O module	Analog input	L60AD4	4 channels, Input: -10...10 V DC, 0...20 mA DC, Output (resolution): 0...20000, -20000...20000, Conversion speed: 20 μs, 80 μs, 1 ms/channel, 18-point terminal block
		L60ADVL8 <b>NEW</b>	8 channels, Input: -10...10 V, Output (resolution)-16000...16000, Conversion speed: 1 ms/channels 18-point terminal block
		L60ADIL8 <b>NEW</b>	8 channels, Input: 0...20 mA DC, Output (resolution): 0...8000, Conversion speed: 1 ms/channels 18-point terminal block
		L60AD4-2GH	4 channels, Input: -10...10 V DC, 0...20 mA DC, Output (resolution): 0...32000, -32000...32000, Conversion speed: 40 μs/2 channels, 18-point terminal block, Dual channel isolation
	Analog output	L60DA4	4 channels, Input (resolution): 0...20000, -20000...20000, Output: -10...10 V DC, 0...20 mA DC, Conversion speed: 20 μs/channel, 18-point terminal block
Analog I/O	L60AD2DA2	Input specifications : 2 channels, Input: -10...10 V DC, 0...20 mA DC, Output (resolution): 0...12000, -16000...16000, Conversion speed: 80 μs/channel, Output specifications : 2 channels, Input (resolution): 0...12000, -16000...16000, Output: -10...10 V DC, 0...20 mA DC, Conversion speed: 80 μs/channel, 18-point terminal block	
Temperature Control module	Thermocouple	L60TCTT4	4 channels (normal mode) /2 channels (heating-cooling control), Thermocouple (K, J, T, B, S, E, R, N, U, L, PL II, W5Re/W26Re), No Heater disconnection detection function, sampling cycle: 250 ms/4 channels, 500 ms/4 channels, Channel isolated, 18 point terminal block
		L60TCTT4BW	4 channels (normal mode) /2 channels (heating-cooling control), Thermocouple (K, J, T, B, S, E, R, N, U, L, PL II, W5Re/W26Re), Heater disconnection detection function, Sampling cycle: 250 ms/4 channels, 500 ms/4 channels, Channel isolated, 18 point terminal block x2
	RTD	L60TCRT4	4 channels (normal mode) /2 channels (heating-cooling control), Platinum type resistive temperature device(Pt100, JPt100), No Heater disconnection detection function, Sampling cycle: 250 ms/4 channels, 500 ms/4 channels, Channel isolated, 18 point terminal block
		L60TCRT4BW	4 channels (normal mode) /2 channels (heating-cooling control), Platinum type resistive temperature device (Pt100, JPt100), Heater disconnection detection function, Sampling cycle: 250 ms/4 channels, 500 ms/4 channels, Channel isolated, 18 point terminal block x2
Simple motion module	SSCNET III/H	LD77MS2*1	2 axes, 2-axis linear interpolation, 2-axis circular interpolation, synchronous control, Control unit: mm, inch, degree, pulse, Number of positioning data: 600 data/axis, SSCNET III/H connectivity
		LD77MS4*1	4 axes, 2-/3-/4-axis linear interpolation, 2-axis circular interpolation, synchronous control, Control unit: mm, inch, degree, pulse, Number of positioning data: 600 data/axis, SSCNET III/H connectivity
		LD77MS16*1	16 axes, 2-/3-/4-axis linear interpolation, 2-axis circular interpolation, synchronous control, Control unit: mm, inch, degree, pulse, Number of positioning data: 600 data/axis, SSCNET III/H connectivity
	SSCNET III	LD77MH4*1	4 axes, 2-/3-/4-axis linear interpolation, 2-axis circular interpolation, synchronous control, Control unit: mm, inch, degree, pulse, Number of positioning data: 600 data/axis, SSCNET III connectivity
		LD77MH16*1	16 axes, 2-/3-/4-axis linear interpolation, 2-axis circular interpolation, synchronous control, Control unit: mm, inch, degree, pulse, Number of positioning data: 600 data/axis, SSCNET III connectivity
Positioning module	Open collector	LD75P1	1 axis, Control unit: mm, inch, degree, pulse, Number of positioning data: 600 data/axis, Maximum output pulse: 200 kpps, 40-pin connector
		LD75P2	2 axes, 2-axis linear interpolation, 2-axis circular interpolation, Control unit: mm, inch, degree, pulse, Number of positioning data: 600 data/axis, Maximum output pulse: 200 kpps, 40-pin connector
		LD75P4	4 axes, 2-/3-/4-axis linear interpolation, 2-axis circular interpolation, Control unit: mm, inch, degree, pulse, Number of positioning data: 600 data/axis, Maximum output pulse: 200 kpps, 40-pin connector x2
	Differential driver	LD75D1	1 axis, Control unit: mm, inch, degree, pulse, Number of positioning data: 600 data/axis, Maximum output pulse: 4 Mpps, 40-pin connector
		LD75D2	2 axes, 2-axis linear interpolation, 2-axis circular interpolation, Control unit: mm, inch, degree, pulse, Number of positioning data: 600 data/axis, Maximum output pulse: 4 Mpps, 40-pin connector
		LD75D4	4 axes, 2-/3-/4-axis linear interpolation, 2-axis circular interpolation, Control unit: mm, inch, degree, pulse, Number of positioning data: 600 data/axis, Maximum output pulse: 4 Mpps, 40-pin connector x2
High-speed counter module	LD62	2 channels, 200/100/10 kpps, Count input signal: 5/12/24 V DC, External input: 5/12/24 V DC, Coincidence output: transistor (sink), 12/24 V DC, 0.5 A/point, 2 A/common, 40-pin connector	
	LD62D	2 channels, 500/200/100/10 kpps, Count input signal: EIA standards RS-422-A (Differential line driver level), External input: 5/12/24 V DC, Coincidence output: transistor (sink), 12/24 V DC, 0.5 A/point, 2 A/common, 40-pin connector	

\*1: The connector is not appended. Please obtain an LD77MHIOCON separately.

## MELSEC-L series

Type	Model	Outline	
Network module	CC-Link IE Field Network	LJ71GF11-T2 LJ72GF15-T2*1	Master/Local station Remote station (Head module with END cover)
	CC-Link	LJ61BT11	Master/Local station, CC-Link Ver.2.0 compatible
	CC-Link/LT	LJ61CL12	Master station, CC-Link/LT system compatible
	SSCNET III/H	LJ72MS15*2	Remote station (Head module with END cover)
	Ethernet interface	LJ71E71-100	10BASE-T/100BASE-TX BACnet™ client function, MODBUS® TCP master function (using predefined protocol support function)
	Serial communication	LJ71C24	RS-232: 1 channel, RS-422/485: 1 channel, Total transmission speed of 2 channels: 230.4 kbps MODBUS® RTU master function (using predefined protocol support function)
		LJ71C24-R2	RS-232: 2 channels, Total transmission speed of 2 channels: 230.4 kbps MODBUS® RTU master function (using predefined protocol support function)
Digital link sensor	LJ51AW12AL DB	AnyWireASLINK system compatible master module	

\*1: The CPU module, branch and extension module, display unit, RS-232 adapter, CC-Link IE Field Network master/local module and Ethernet interface module cannot be mounted on a system using LJ72GF-T2.

\*2: The CPU module, branch and extension module, display unit, RS-232 adapter, temperature control module, simple motion module, positioning module, CC-Link IE Field Network master/local module, CC-Link IE Field network head module, CC-Link master/local module, CC-Link/LT master module, Ethernet interface module, serial communication module, and AnyWireASLINK master module cannot be mounted on a system using LJ72MS15.

## Compatible module for each protocol

Compatible protocol	Compatible module	Model	Outline
SLMP (MC protocol)	CPU (Built-in Ethernet)	L02CPU(-P) L06CPU(-P) L26CPU(-P) L26CPU(-P)BT	SLMP server function (only MC protocol QnA compatible 3E frame) SLMP client function (using predefined protocol support function)
	Ethernet interface module	LJ71E71-100	SLMP server function (including MC protocol) SLMP client function (using predefined protocol support function)
BACnet™	CPU (Built-in Ethernet)	L02CPU(-P) L06CPU(-P) L26CPU(-P) L26CPU(-P)BT	Compatible BACnet™ object: Analog Input (AI), Binary Input (BI), Binary Output (BO), Accumulator (AC) (using predefined protocol support function)
	Ethernet interface module	LJ71E71-100	
MODBUS®/TCP	CPU (Built-in Ethernet)	L02CPU(-P) L06CPU(-P) L26CPU(-P) L26CPU(-P)BT	MODBUS®/TCP communication master function (using predefined protocol support function)
	Ethernet interface module	LJ71E71-100	
MODBUS®	CPU (Built-in RS-232)	L02SCPU(-P)	MODBUS®RTU communication master function (using predefined protocol support function)
	RS-232 adapter	L6ADP-R2	
	RS-422/485 adapter	L6ADP-R4	
	Serial Communication Modules	LJ71C24(-R2)	

## Options

Type	Model	Outline
Connector	A6CON1*3*4	Soldering type 32-point connector (40-pin connector)
	A6CON2*3*4	Crimp contact type 32-point connector (40-pin connector)
	A6CON3*3*5	Flat cable pressure welding type 32-point connector (40-pin connector)
	A6CON4*3*4	Soldering type 32-point connector (40-pin connector, cable connectable in bidirection)
Connector/terminal block converter module	A6TBXY36*6*7*8	For positive common type input module and sink type output module (Standard type)
	A6TBXY54*6*7*8	For positive common type input module and sink type output module (2-wire type)
	A6TBX70*6*9	For positive common type input module (3-wire type)

\*3: Available for L02CPU, L02CPU-P, L06CPU, L06CPU-P, L26CPU, L26CPU-P, L26CPU-BT, L26CPU-PBT, LX41C4, LX42C4, LY41NT1P, LY42NT1P, LY41PT1P, LY42PT1P, LH42C4NT1P and LH42C4PT1P.

\*4: Available for LD75P1, LD75P2, LD75P4, LD75D1, LD75D2, LD75D4, LD62 and LD62D.

\*5: When used with L02CPU, L02CPU-P, L06CPU, L06CPU-P, L26CPU, L26CPU-P, L26CPU-BT, L26CPU-PBT, only when all points are general-purpose I/O.

\*6: Available for LX41C4 and LX42C4. (Positive common only)

\*7: Available for LY41NT1P, LY42NT1P, LY41PT1P and LY42PT1P.

\*8: Available for LH42C4NT1P and LH42C4PT1P. (Input side only when using plus common.)

\*9: Available for LH42C4NT1P and LH42C4PT1P. (Input side only when using plus common. Output side is not usable.)

## Ethernet related products

Type	Model	Outline	
Wireless LAN Adapter	U.S.A.	NZ2WL-US*10*11 DB	Conforms to IEEE 802.11a, IEEE 802.11b, IEEE 802.11g standards
	Europe	NZ2WL-EU*10*11 DB	Conforms to IEEE 802.11a, IEEE 802.11b, IEEE 802.11g standards
	China	NZ2WL-CN*10*11 DB	Conforms to IEEE 802.11a, IEEE 802.11b, IEEE 802.11g standards
	Korea	NZ2WL-KR*10*11 DB	Conforms to IEEE 802.11a, IEEE 802.11b, IEEE 802.11g standards
	Taiwan	NZ2WL-TW*10*11 DB	Conforms to IEEE 802.11a, IEEE 802.11b, IEEE 802.11g standards
Industrial switching HUB	NZ2EHG-T8 DB	10 Mbps/100 Mbps/1 Gbps AUTO-MDIX, DIN rail mountable, 8 ports	
	NZ2EHF-T8 DB	10 Mbps/100 Mbps AUTO-MDIX, DIN rail mountable, 8 ports	
CC-Link IE Field Network Ethernet Adapter	NZ2GF-ETB	100 Mbps/1 Gbps compatible station for expanding CC-Link IE Field Networks	

\*10: Each product is usable only in the respective country.

\*11: Both access points and stations are supported, and can be switched with the settings.

## MELSOFT\*1 — Programming Tool

Type	Model	Outline
MELSOFT GX Works2	SW1DNC-GXW2-E	Programmable controller engineering software (Functions integrated software: Programming, simulation, module settings, and monitoring)
MELSOFT iQ Works	SW2DND-IQWK-E (DVD-ROM edition)	FA engineering software*2 <ul style="list-style-type: none"> <li>• System Management Software: MELSOFT Navigator MELSOFT Navigator is a comprehensive system configuration solution that serves as a launching pad for the other software packages.</li> <li>• Controller Programming Software: MELSOFT GX Works3, GX Works2, GX Developer The next generation configuration, programming, and simulation software for FX, L, and Q Series controllers.</li> <li>• Motion Programming Software: MELSOFT MT Works2 Design and maintenance tool for motion controllers.</li> <li>• HMI Programming Software: MELSOFT GT Works3 GOT configuration, screen design, and maintenance tool.</li> <li>• Robot Programming Software: MELSOFT RT ToolBox2 mini Programming and total engineering tool for robots</li> <li>• Inverter Setup Software: MELSOFT FR Configurator2 Simulation, setting, and monitoring tool for inverters.</li> </ul>
MELSOFT MX Component	SW4DNC-ACT-E	ActiveX® library for communication
MELSOFT MX Sheet	SW2DNC-SHEET-E*3	Excel® communication support tool

\*1: For details on the software versions compatible with each module, refer to the manual for each product.

Please contact your local Mitsubishi Electric sales office or representative for the latest information about MELSOFT software versions and compatible operating systems.

\*2: For detailed information about supported modules, refer to the manuals of the relevant software package.

\*3: MX Component is required to use MX Sheet.

## Compliance with international quality assurance standards

All of Mitsubishi Electric's FA products have acquired the international quality assurance "ISO9001" and environment management system standard "ISO14001" certification. Mitsubishi Electric's products also comply with various safety standards, including UL standards.

\*For jointly developed and partner products, guaranteed quality standards may differ. Please refer to the product manuals for details.

### Safety Standards





# FA Products

## HMI | Graphic Operation Terminal GOT2000 Series GT27 Model



To the top of HMIs with further user-friendly, satisfactory standard features.

- ◎ Comfortable screen operation even if high-load processing (e.g. logging, device data transfer) is running. (Monitoring performance is twice faster than GT16)
- ◎ Actual usable space without using a SD card is expanded to 128MB for more flexible screen design.
- ◎ Multi-touch features, two-point press, and scroll operations for more user-friendliness.
- ◎ Outline font and PNG images for clear, beautiful screen display.

### Product Specifications

Screen size	15", 12.1", 10.4", 8.4"
Resolution	XGA, SVGA, VGA
Intensity adjustment	32-step adjustment
Touch panel type	Analog resistive film
Built-in interface	RS-232, RS-422/485, Ethernet, USB, SD card
Applicable software	GT Works3
Input power supply voltage	100 to 240VAC (+10%, -15%), 24VDC (+25%, -20%)

## Inverter | FR-A800 Series



High-functionality, high-performance inverter

- ◎ Realize even higher responsiveness during real sensor-less vector control or vector control, and achieve faster operating frequencies.
- ◎ The latest automatic tuning function supports various induction motors and also sensor-less PM motors.
- ◎ The standard model is compatible with EU Safety Standards STO (PLd, SIL2). Add options to support higher level safety standards.
- ◎ Control and monitor inverters via CC-Link/CC-Link IE Field Network (option interface).

### Product Specifications

Inverter capacity	200V class: 0.4kW to 90kW, 400V class: 0.4kW to 500kW
Control method	High-carrier frequency PWM control (Select from V/F, advanced magnetic flux vector, real sensorless vector or PM sensorless vector control), vector control (when using options)
Output frequency range	0.2 to 590Hz (upper limit is 400Hz when using advanced magnetic flux vector control, real sensorless vector control, vector control or PM sensorless vector control)
Regenerative braking torque (Maximum allowable duty)	200V class: 0.4K to 1.5K (150% at 3%ED) 2.2K/3.7K (100% at 3%ED) 5.5K/7.5K (100% at 2%ED) 11K to 55K (20% continuous) 75K or more (10% continuous), 400V class: 0.4K to 7.5K (100% at 2%ED) 11K to 55K (20% continuous) 75K or more (10% continuous)
Starting torque	200% 0.3Hz (3.7K or less), 150% 0.3Hz (5.5K or more) (when using real sensorless vector, vector control)

## AC Servo | Mitsubishi General-Purpose AC Servo MELSERVO-J4 Series



Industry-leading level of high performance servo

- ◎ Industry-leading level of basic performance: Speed frequency response (2.5kHz), 4,000,000 (4,194,304p/rev) encoder
- ◎ Advanced one-touch tuning function achieves the one-touch adjustment of advanced vibration suppression control II, etc.
- ◎ Equipped with large capacity drive recorder and machine diagnosis function for easy maintenance.
- ◎ 2-axis and 3-axis servo amplifiers are available for energy-conservative, space-saving, and low-cost machines.

### Product Specifications

Power supply specifications	1-phase/3-phase 200V AC, 1-phase 100V AC, 3-phase 400V AC
Command interface	SSCNET III/H, SSCNET III (compatible in J3 compatibility mode), CC-Link IE Field Network interface with Motion, pulse train, analog
Control mode	Position/Speed/Torque/Fully closed loop
Speed frequency response	2.5kHz
Tuning function	Advanced one-touch tuning, advanced vibration suppression control II, robust filter, etc.
Safety function	STO, SS1
Compatible servo motor	SS2, SOS, SLS, SBC, SSM (compatible when combined with motion controller)
Compatible servo motor	Rotary servo motor (rated output: 0.05 to 22kW), linear servo motor (continuous thrust 50 to 3000N), direct drive motor (rated torque: 2 to 240N·m)

## Magnetic Starter

## MS-T Series



Exceed your expectations.

- ◎10A frame model is over 16% smaller with a width of just 36mm!!
- ◎New integrated terminal covers.
- ◎Reduce your coil inventory by up to 50%.
- ◎Be certified to the highest international levels while work is ongoing to gain other country.

### Product specifications

Frame	10 A to 32 A
Applicable standards	Certification to various standards including IEC, JIS, CE, UL, TÜV, CCC.
Terminal cover	Standard terminal cover improves safety, simplifies ordering, and reduces inventory, etc.
Improved wiring	Wiring and operability are improved with streamlining wiring terminal BC specifications.
Operation coil rating	Wide range of operation coil ratings reduces number of coil types from 14 (N Series) to 7 types and simplifies selection.
Option units	Diverse lineup includes Auxiliary Contact Block, Operation Coil Surge Absorber Unit, Mechanical Interlock Unit.

## Low-voltage switch

## Mitsubishi Motor Circuit Breaker MMP-T Series



Introducing a Motor Circuit Breaker from Mitsubishi Electric!

- ◎Design smaller panels by using the Motor Circuit Breaker, various options and MS-T Series Magnetic Contactor.
- ◎Prevent secondary damage with Motor Circuit Breaker and Magnetic Contactor combination.
- ◎Streamlined wiring terminal BC specifications (option) contribute to improving your productivity.
- ◎Supports your overseas business with compliance to various International Standards as well as the UL Type E/F combination.

### Product specifications

Rated current	0.16 A to 32 A (15 types)
Applicable (compliant) standards	Standard product compliant with various International Standards including IEC, JIS, CCC, TÜV and UL (certified)
Wiring types	Bare wire, rod terminal, Y crimp and round crimp supported
Improvement of wiring	Wiring and operability are improved with connection conductor unit and streamlined wiring terminal BC specifications (option)
Optional units	Auxiliary/Alarm Contact Unit, Short-Circuit Indicator Unit, Line Side Terminal Adapter, Connection Conductor Unit, etc., available
DIN rail mounting	Standard product mountable on rail
Finger protection support	Standard product compliant with IP20 from front side of terminals
Application in North America	Type E/F combination certification acquired. Compatible up to maximum SCCR value 50 kA

## Low Voltage Circuit Breakers

## Mitsubishi WS-V Series Molded Case Circuit Breakers, Earth Leakage Circuit Breakers

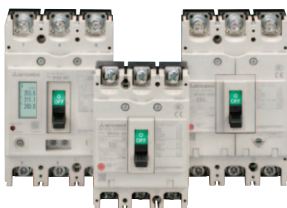

Technologies based on long year experience realize more improved performance.

- ◎The new electronic circuit breakers can display various measurement items.
- ◎Improvement of breaking performance with new breaking technology “Expanded ISTAC”.
- ◎Compliance with global standard for panel and machine export.
- ◎Commoditization of internal accessories for shorter delivery time and stock reduction.

### Product Specifications.

Frame	32-250A Frame
Applicable standard	Applicable to IEC, GB, UL, CSA, JIS and etc.
Expansion of UL listed product line-up	New line-up of 480VAC type with high breaking performance for SCCR requirement
Commoditization of internal accessories	Reduction of internal accessory types from 3 to 1
Commoditization for AC and DC circuit use	Common use of 32/63A frame in both AC and DC circuit
Compact size for easy to use	Thermal adjustable and electronic circuit breakers are same size as 250AF fixed type
Measuring Display Unit (MDU) breakers	MDU breakers measure, display and transmit energy date to realize energy management.

## Robot

## MELFA F Series



High speed, high precision and high reliability industrial robot

- ◎ Compact body and slim arm design, allowing operating area to be expanded and load capacity increased.
- ◎ The fastest in its class using high performance motors and unique driver control technology.
- ◎ Improved flexibility for robot layout design considerations.
- ◎ Optimal motor control tuning set automatically based on operating position, posture, and load conditions.

### Product Specifications

Degrees of freedom	Vertical:6    Horizontal:4
Installation	Vertical:Floor-mount, ceiling mount, wall mount (Range of motion for J1 is limited) Horizontal:Floor-mount
Maximum load capacity	Vertical:2-20kg    Horizontal:3-20kg
Maximum reach radius	Vertical:504-1503mm    Horizontal:350-1,000mm

## CNC

## MITSUBISHI CNC M70V Series



A global standard model that offers both high speed and accuracy.

- ◎ Permits commands in 0.1 μm increments and internal interpolation control in 1nm increments for smooth, high-accuracy machining.
- ◎ Intuitive operation and display of hierarchical screens, with an Ethernet I/F (standard feature) for easy program management.
- ◎ Offers a more compact control panel by integrating the display and control.
- ◎ A lineup that includes Type A for compound lathes, and Type B for tapping centers.

### Product specifications

Maximum number of control axes (NC axes + spindles + PLC axes)	Type A: 11 axes    Type B: 9 axes
Maximum number of part systems	Type A: 2 systems    Type B: 1 system
Least command increment	0.1 μm
Least control increment	1nm
Maximum program capacity	Type A: 2,000 KB (5,120 m)    Type B: 500 KB (1,280 m)
Maximum PLC program capacity	Type A: 32,000 steps    Type B: 20,000 steps
Main functions (for machining center)	OMR-DD control (high-speed synchronous tapping), High-speed & high-accuracy control, Tool center point control, Inclined surface machining, etc.
Main functions (for lathes)	Milling interpolation, 2-system simultaneous thread cutting, Control axis synchronization across part systems, Control axis superimposition, Mixed control, etc.

Microsoft, Windows, Excel, ActiveX, are registered trademarks of Microsoft Corporation in the United States and other countries.

Ethernet is a trademark of Xerox Corporation.

MODBUS is a registered trademark of Schneider Electric USA, Inc.

BACnet is a trademark of ASHRAE Standards Committee.

Cognex, In-Sight, DataMan, VisionView and UltraLight are registered trademarks of Cognex Corporation.

1DMax+, 2DMax+ and Hotbars are trademarks of Cognex Corporation.

All other company names and product names used in this document are trademarks or registered trademarks of their respective companies.

### Precautions before use

This publication explains the typical features and functions of the products herein and does not provide restrictions or other information related to usage and module combinations. Before using the products, always read the product user manuals. Mitsubishi Electric will not be held liable for damage caused by factors found not to be the cause of Mitsubishi Electric; opportunity loss or lost profits caused by faults in Mitsubishi Electric products; damage, secondary damage, or accident compensation, whether foreseeable or not, caused by special factors; damage to products other than Mitsubishi Electric products; or any other duties.

### ⚠ For safe use

- To use the products given in this publication properly, always read the relevant manuals before beginning operation.
- The products have been manufactured as general-purpose parts for general industries, and are not designed or manufactured to be incorporated in a device or system used in purposes related to human life.
- Before using the products for special purposes such as nuclear power, electric power, aerospace, medicine or passenger-carrying vehicles, consult with Mitsubishi Electric.
- The products have been manufactured under strict quality control. However, when installing the products where major accidents or losses could occur if the products fail, install appropriate backup or fail-safe functions in the system.

Country/Region	Sales office	Tel/Fax
USA	MITSUBISHI ELECTRIC AUTOMATION, INC. 500 Corporate Woods Parkway, Vernon Hills, IL 60061, U.S.A.	Tel : +1-847-478-2100 Fax : +1-847-478-2253
Mexico	MITSUBISHI ELECTRIC AUTOMATION, INC. Mexico Branch Mariano Escobedo #69, Col. Zona Industrial, Tlalnepantla Edo, C.P.54030, Mexico	Tel : +52-55-3067-7500
Brazil	MITSUBISHI ELECTRIC DO BRASIL COMÉRCIO E SERVIÇOS LTDA. Rua Jussara, 1750-Bloco B Anexo, Jardim Santa Cecilia, CEP 06465-070, Barueri-SP, Brasil	Tel : +55-11-4689-3000 Fax : +55-11-4689-3016
Germany	MITSUBISHI ELECTRIC EUROPE B.V. German Branch Gothaer Strasse 8, D-40880 Ratingen, Germany	Tel : +49-2102-486-0 Fax : +49-2102-486-1120
UK	MITSUBISHI ELECTRIC EUROPE B.V. UK Branch Travellers Lane, Hatfield, Hertfordshire, AL10 8XB, U.K.	Tel : +44-1707-28-8780 Fax : +44-1707-27-8695
Ireland	MITSUBISHI ELECTRIC EUROPE B.V. Irish Branch Westgate Business Park, Ballymount, IRL-Dublin 24, Ireland	Tel : +353-1-4198800 Fax : +353-1-4198890
Italy	MITSUBISHI ELECTRIC EUROPE B.V. Italian Branch Centro Direzionale Colleoni-Palazzo Sirio Viale Colleoni 7, 20864 Agrate Brianza(Milano) Italy	Tel : +39-039-60531 Fax : +39-039-6053-312
Spain	MITSUBISHI ELECTRIC EUROPE, B.V. Spanish Branch Carretera de Rubí, 76-80-Apdo. 420, 08173 Sant Cugat del Vallés (Barcelona), Spain	Tel : +34-935-65-3131 Fax : +34-935-89-1579
France	MITSUBISHI ELECTRIC EUROPE B.V. French Branch 25, Boulevard des Bouvets, F-92741 Nanterre Cedex, France	Tel : +33-1-55-68-55-68 Fax : +33-1-55-68-57-57
Czech Republic	MITSUBISHI ELECTRIC EUROPE B.V. Czech Branch Avenir Business Park, Radlicka 751/113e, 158 00 Praha5, Czech Republic	Tel : +420-251-551-470 Fax : +420-251-551-471
Poland	MITSUBISHI ELECTRIC EUROPE B.V. Polish Branch ul. Krakowska 50, 32-083 Balice, Poland	Tel : +48-12-630-47-00 Fax : +48-12-630-47-01
Sweden	MITSUBISHI ELECTRIC EUROPE B.V. (Scandinavia) Fjellievägen 8, SE-22736 Lund, Sweden	Tel : +46-8-625-10-00 Fax : +46-46-39-70-18
Russia	MITSUBISHI ELECTRIC EUROPE B.V. Russian Branch St. Petersburg office Piskarevsky pr. 2, bld 2, lit "Sch", BC "Benua", office 720; RU-195027 St. Petersburg, Russia	Tel : +7-812-633-3497 Fax : +7-812-633-3499
Turkey	MITSUBISHI ELECTRIC TURKEY A.Ş Ümraniye Branch Serifali Mahallesi Nutuk Sokak No:5, TR-34775 Umraniye, Istanbul, Turkey	Tel : +90-216-526-3990 Fax : +90-216-526-3995
Dubai	MITSUBISHI ELECTRIC EUROPE B.V. Dubai Branch Dubai Silicon Oasis, P.O.BOX 341241, Dubai, U.A.E.	Tel : +971-4-3724716 Fax : +971-4-3724721
South Africa	ADROIT TECHNOLOGIES 20 Waterford Office Park, 189 Witkoppen Road, Fourways, Johannesburg, South Africa	Tel : +27-11-658-8100 Fax : +27-11-658-8101
China	MITSUBISHI ELECTRIC AUTOMATION (CHINA) LTD. No.1386 Hongqiao Road, Mitsubishi Electric Automation Center, Shanghai, China	Tel : +86-21-2322-3030 Fax : +86-21-2322-3000
Taiwan	SETSUYO ENTERPRISE CO., LTD. 6F, No.105, Wugong 3rd Road, Wugu District, New Taipei City 24889, Taiwan, R.O.C.	Tel : +886-2-2299-2499 Fax : +886-2-2299-2509
Korea	MITSUBISHI ELECTRIC AUTOMATION KOREA CO., LTD. 7F-9F, Gangseo Hangang Xi-tower A, 401, Yangcheon-ro, Gangseo-Gu, Seoul 157-801, Korea	Tel : +82-2-3660-9530 Fax : +82-2-3664-8372
Singapore	MITSUBISHI ELECTRIC ASIA PTE. LTD. 307, Alexandra Road, Mitsubishi Electric Building, Singapore 159943	Tel : +65-6473-2308 Fax : +65-6476-7439
Thailand	MITSUBISHI ELECTRIC FACTORY AUTOMATION (THAILAND) CO., LTD. 12th Floor, SV.City Building, Office Tower 1, No. 896/19 and 20 Rama 3 Road, Kwaeng Bangpongpan, Khet Yannawa, Bangkok 10120, Thailand	Tel : +66-2682-6522 Fax : +66-2682-6020
Vietnam	MITSUBISHI ELECTRIC VIETNAM COMPANY LIMITED Hanoi Branch 6-Floor, Detech Tower, 8 Ton That Thuyet Street, My Dinh 2 Ward, Nam Tu Liem District, Hanoi, Vietnam	Tel : +84-4-3937-8075 Fax : +84-4-3937-8076
Indonesia	PT. MITSUBISHI ELECTRIC INDONESIA Gedung Jaya 11th Floor, JL. MH. Thamrin No.12, Jakarta Pusat 10340, Indonesia	Tel : +62-21-3192-6461 Fax : +62-21-3192-3942
India	MITSUBISHI ELECTRIC INDIA PVT. LTD. Pune Branch Emerald House, EL-3, J Block, M.I.D.C Bhosari, Pune-411026, Maharashtra, India	Tel : +91-20-2710-2000 Fax : +91-20-2710-2100
Australia	MITSUBISHI ELECTRIC AUSTRALIA PTY. LTD. 348 Victoria Road, P.O. Box 11, Rydalmere, N.S.W 2116, Australia	Tel : +61-2-9684-7777 Fax : +61-2-9684-7245

## MITSUBISHI ELECTRIC CORPORATION

HEAD OFFICE: TOKYO BUILDING, 2-7-3, MARUNOUCHI, CHIYODA-KU, TOKYO 100-8310, JAPAN  
NAGOYA WORKS: 1-14, YADA-MINAMI 5, HIGASHI-KU, NAGOYA, JAPAN

Mitsubishi Electric Corporation Nagoya Works is a factory certified for ISO14001 (standards for environmental management systems) and ISO9001(standards for quality assurance management systems)

