

One-touch Servo
MELSERVO-JN



**Easy Operation and High Performance,
with Small Body!!**

One-touch Servo MELSERVO-JN

The one-touch servo MELSERVO-JN, produced to offer you a high-performance operation control with much simpler process! It brings the optimal operations to your factory line with the easiest operations like never before, such as one-touch tuning.



Products shown in actual size.

Servo amplifier
(MR-JN-10A)

Servo motor
(HF-KN053)

Servo amplifier		Control mode				Power supply voltage	Compatible servo motor capacity (kW)
Model	Command interface	Position	Speed	Torque	Positioning		
MR-JN-□A (1)	Pulse train	●	●*1	●*1	●*2	Main circuit: 1-phase 200VAC/100VAC*3 Control circuit: 24VDC	0.05 to 0.4*4

*1 Analog interface is not equipped. Internal setting only. *2 Positioning can be performed either with point table method or with program method.
*3 MR-JN-10A1 and -20A1 are available. *4 The capacity is 0.05kW to 0.2kW for 1-phase 100VAC.

Servo motor		Rated speed (Maximum speed) (r/min)	Rated output capacity (kW)	Electromagnetic brake (B)	Reducer		IP rating
Servo motor series	●: Supported —: Not supported				for general industrial machine (G1)	for precision application (G5, G7)	
HF-KN series	●	3000 (4500)	0.05, 0.1, 0.2, 0.4	●	—	—	IP65*5

Geared servo motor		Rated speed (Maximum speed) (r/min)	Rated output capacity (kW)	Reducer for general industrial machine (G1)	Reducer for precision application (G5, G7)	Electromagnetic brake (B)	IP rating
Servo motor series	●: Supported						
HF-KP series	●	3000 (4500)*6	0.05, 0.1, 0.2, 0.4	1/5, 1/12, 1/20*7	1/5, 1/11, 1/21, 1/33, 1/45	●	IP44*5

*5 The shaft-through portion is excluded.

*6 This speed is applicable when using the servo motor in combination with MR-JN series servo amplifier.

*7 This reduction ratio is nominal value. For actual reduction ratio, refer to "Geared Servo Motor Specifications" in this catalog.

is now available!



One-touch tuning

Servo tuning is completed just by pressing the AUTO button on the front of the servo amplifier.



Tough drive function

Operation will continue even when a temporal change in load, power supply or resonance frequency occurs.



Built-in Regenerative Resistor

A less wiring and a space-saving installation are realized by integrating the regenerative resistor to the 200W or larger servo amplifier as standard equipment (as compared to the external option) !



Separated power supply for main and control circuits

The main circuit power supply can be turned off separately to enhance your safety during maintenance!



Advanced Vibration Suppression Control

The auto tuning function enables the optimal operations!



Built-in positioning function

Built-in positioning function enables easy positioning operation without a controller!

INDEX

■ Features	P. 3
■ Application Examples	P. 8
■ Servo Support Software	
Capacity Selection Software	P. 9
MR Configurator (Setup software)	P.10
■ Model Designation	
Servo Amplifiers	P. 11
Servo Motors	P. 11
■ Connections with Peripheral Equipment	P. 12
■ Servo Amplifier Specifications	P. 13
■ Standard Wiring Diagram	
Position Control Operation	P. 14
Speed Control Operation	P. 16
Torque Control Operation	P. 17
■ Positioning Function (Point Table Method)	
Point Table Method	P. 18
Command and Operation Mode	P. 19
Standard Wiring Diagram	P. 20
■ Positioning Function (Program Method)	
Command List	P. 21
Program Examples	P. 22
Command and Operation Mode	P. 23
Standard Wiring Diagram	P. 24
■ Servo Motor Specifications and Torque Characteristics	
HF-KN Series Servo Motor	P. 25
HF-KP Series Geared Servo Motor	P. 26
■ Servo Motor Special Specifications	
Geared Servo Motor Specifications	P. 27
Electromagnetic Brake Specifications	P. 27
Special Shaft End Specifications	P. 28
■ Optional Cables and Connectors	P. 29
■ Ordering Information for Customers (Connectors)	P. 32
■ Options	
Optional Regeneration Unit	P. 33
Junction Terminal Block	P. 33
Manual Pulse Generator	P. 33
■ Peripheral Equipment	
Electrical Wires, Circuit Breakers, Magnetic Contactors	P. 34
Radio Noise Filter	P. 34
Line Noise Filter	P. 34
Data Line Filter	P. 34
Surge Killer	P. 34
EMC Filter	P. 35
Power Factor Improvement AC Reactor	P. 35
■ Servo Support Software	
Specifications and Operating Conditions	P. 36
■ Servo Amplifier Dimensions	P. 37
■ Servo Motor Dimensions	
HF-KN Series Servo Motor	P. 38
HF-KP Series Geared Servo Motor	P. 39
■ Cautions	P. 42
■ Warranty	P. 43
■ Global FA Centers	P. 46

All steps from installation to wiring, setup and operation are easy!

MELSERVO-JN

1 Pursuing of "EASY" for both Operation and Support

■ Fuss-free Quick tuning with one-touch

Various adjustments for bringing out the full-performance of the servo, such as estimation of load to motor inertia moment ratio, gain adjustment or machine resonance suppression, can be executed automatically with one-touch operation. (Patent pending)

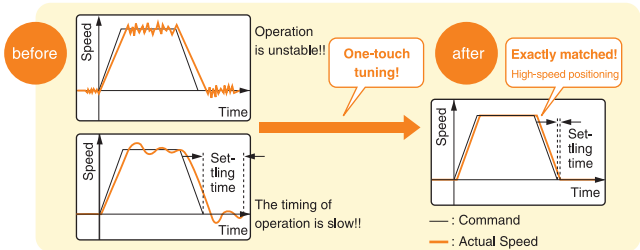
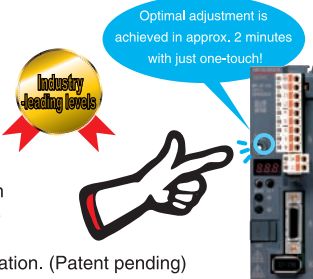

■ 1-phase 100VAC and 200VAC for main circuit power supply

Besides 1-phase 200VAC servo amplifier, 1-phase 100VAC servo amplifier is available.

* 100VAC servo amplifier is available in 200W or smaller.

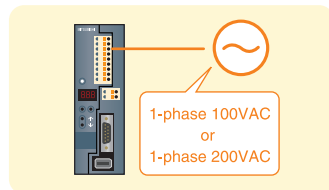

■ Easy power supply wiring without a screwdriver

All wiring can be completed without a driver!

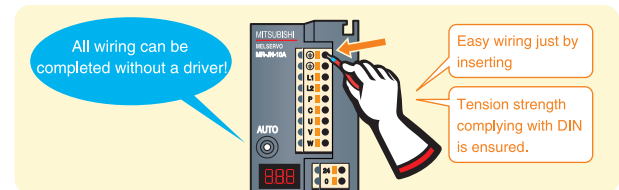

■ Easy setting of electronic gear

Calculation of command pulse frequency and travel distance of the ball screw is simple since the number of command pulses per revolution of motor is set to 10000 by default. Additionally, rotation angle is controlled easily just by setting one parameter.

Setting Examples

In the case of the number of command pulses per revolution is set to 10000 (default):

10mm lead ball screw moves 1 μ m per pulse. (10mm per 10000 pulses)

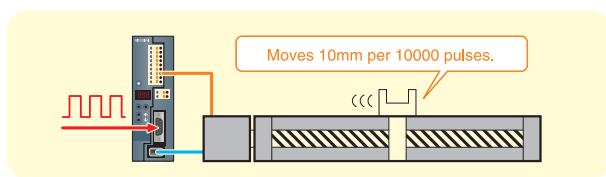

In the case of the number of command pulses per revolution is set to 36000:

The servo motor rotates 0.01 degrees per pulse. (1 degree per 100 pulses)

*This is when not using a reducer.

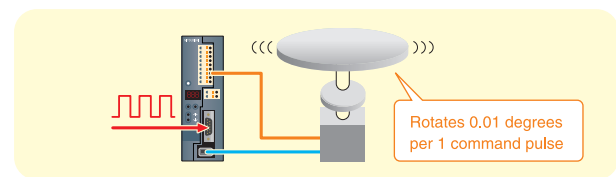

■ Support your installation totally

- Freeware for capacity calculation
Capacity selection software (MRZJW3-MOTSZ111E) enables optimal selections of servo motor and servo amplifier for your system. This software is available for free download. Contact your local sales office for more details.



Screen of capacity selection software

- Quick installation guide
We provide "QUICK INSTALLATION GUIDE" (coming soon) which explains the processes from selection of the product to installation and adjustment. This guide helps you to complete the start up operation easily.



QUICK INSTALLATION GUIDE (L(NA)03052ENG)



2 Pursuing "RELIABLE" from the Product Design Phase

Reliable operation with "tough drive function" *1

● Overload tough drive function

By using the overload tough drive function, machine operation is adjusted automatically to prevent an alarm occurrence when load changes in the machine are detected, and thereby reduces time losses caused by machine stops. (Patent pending)

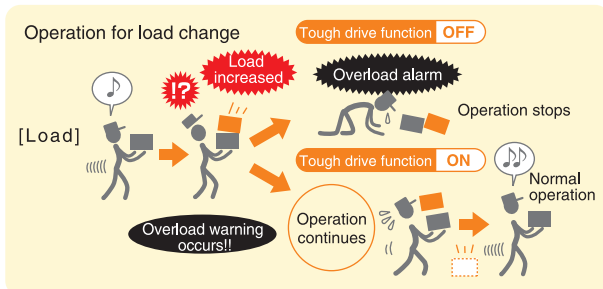

● Instantaneous power failure tough drive function

When an instantaneous power failure is detected, power charged on the main circuit capacitor is supplied to keep the system running.

* Low voltage alarm may occur depending on the load conditions.

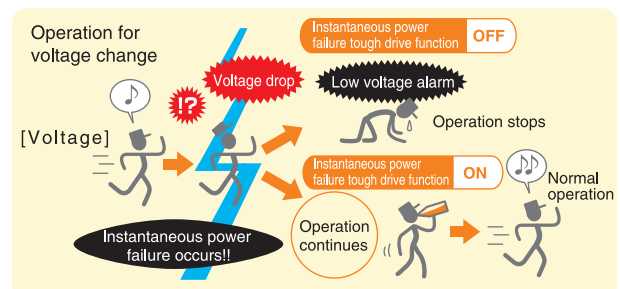

● Vibration tough drive function

This function readjusts the machine resonance suppression filter automatically and prevents resonance when a machine resonance frequency is changed due to aging distortion.

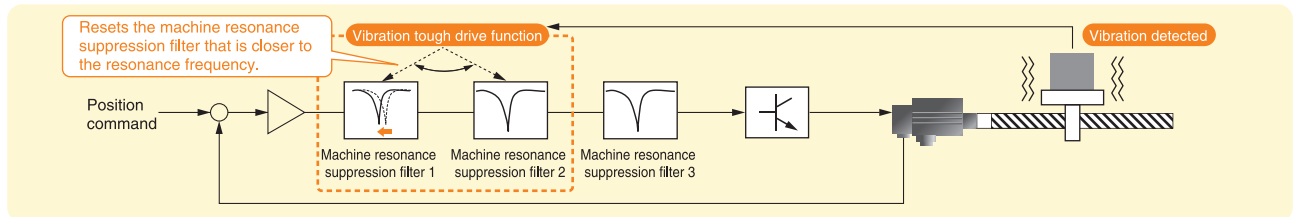

*1 Tough drive function is activated by setting a parameter.

Safe maintenance due to separated power supply for main and control circuits

Because each of the main circuit power supply (1-phase 200VAC or 1-phase 100VAC) and the control circuit power supply (24VDC) has the respective connectors, the main circuit power supply can be turned off separately. It makes the maintenance such as parameter setting or checking of machine status safer when a trouble occurs.

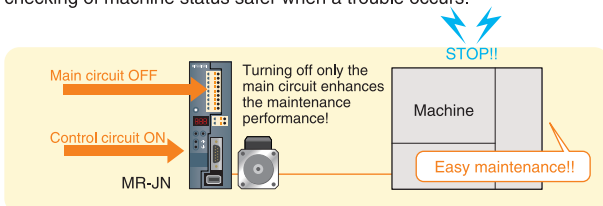

With fanless body

The maintenance performance is improved by eliminating a cooling fan from the servo amplifier. There is no need to worry about the life of the cooling fan.

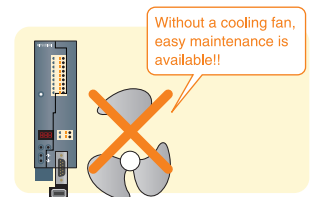

"Drive recorder function" for quick response to troubleshooting

● This function automatically records data before and after the alarm occurrence. The recorded data is available in graph even after the power is off. This enables identifying the cause of a trouble and finding its early solution.

● This function selects data automatically to be recorded corresponding to alarms. Information on the causes of alarm is extracted and monitored easily.

The data right before the alarm occurrence is available in graph!

* MR Configurator is required to display data in the drive recorder in graph.

Example: When error excessive alarm occurs.

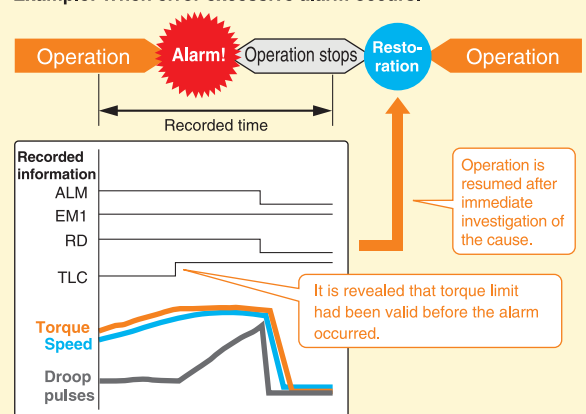

Along with easiness! MELSERVO-JN has a variety of advanced functions.

3 "Reduced Setting Space" Makes Your Manufacturing Floor More Comfortable

High performance with small body! Even high-accuracy positioning can be done easily!!

- The servo motor is equipped with high-resolution encoder (131072p/rev), enabling both high-accuracy positioning and speed stability in low speed. The servo amplifier supports 1Mpps command pulse frequency, realizing high-accuracy positioning. MELSERVO-JN can be used for various applications.

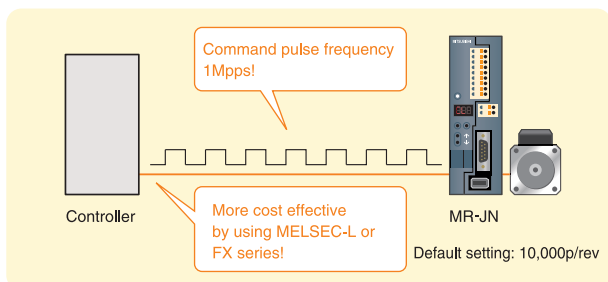

- MR-C series servo amplifier can be replaced easily by the MR-JN since both of these servo amplifiers have the same mounting dimensions.

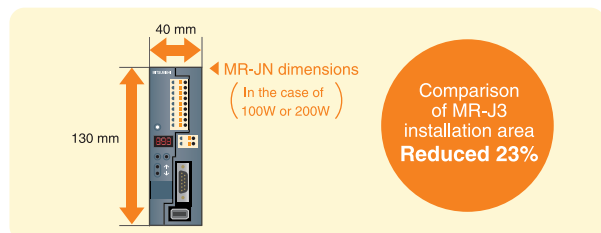

The servo amplifier can be installed closely with each other.

- The MR-JN servo amplifiers can be installed closely with each other.
- * The operation environment differs when mounted closely. For details, refer to "Servo Amplifier Specifications" and "Cautions concerning use" in this catalog.

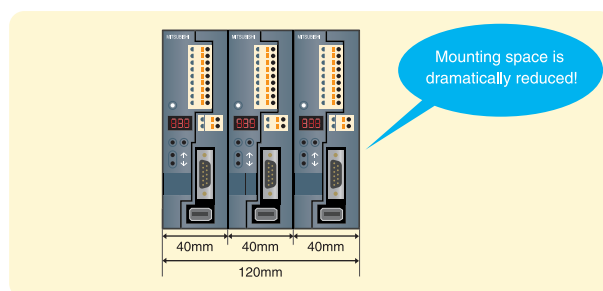

Equipped with built-in regenerative resistor

- 200W or larger servo amplifier has a built-in regenerative resistor. This space-saving servo amplifier contributes to smaller system configurations.

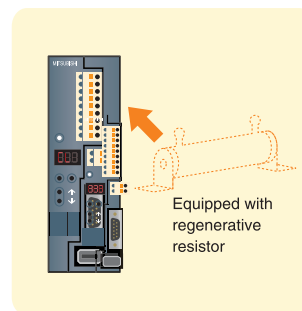

4 Large Selection of Servo Motors

Compact high-performance servo motor HF-KN series

- Capacity: 50W to 400W
- By mounting the high-resolution incremental encoder (131072p/rev), both "high-accuracy positioning" and "speed stability in low speed" are enabled.
- Servo motors with electromagnetic brake are also available.
- Cables can be led out either in direction or in opposite direction of the motor shaft according to the selected cables.
- The HF-KN series servo motor is rated IP65 as standard. (excluding the shaft-through portion)

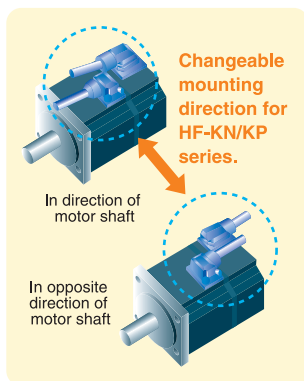

Geared servo motors, HF-KP series, are also available

- Capacity: 50W to 400W
- HF-KP series with reducer are available.
 - G1: for general industrial machines
 - G5: flange output type reducer for precision applications
 - G7: shaft output type reducer for precision applications
 These servo motors are flange mounting type.
- Servo motors with electromagnetic brake are also available.
- The HF-KP series with reducer is rated IP44 as standard. (excluding the shaft-through portion)



Wide motor selection including geared servo motors



5 Equipped with MR-J3-level High Functionality

Extended adjustment functions by the auto tuning

Advanced vibration suppression control

The residual vibration with low frequency (up to 100Hz) is suppressed automatically.

* An optimal filter is set automatically by the auto tuning function.

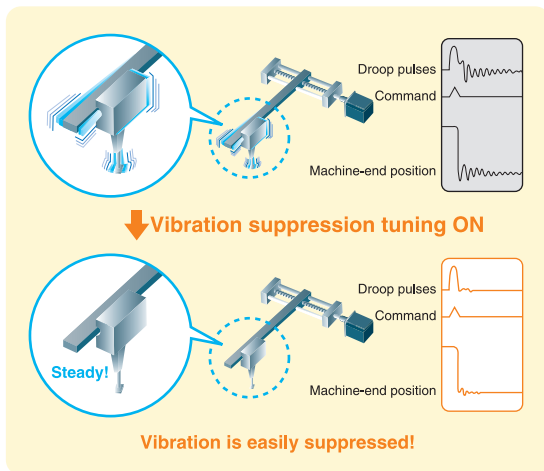

Adaptive filter II

High frequency machine resonance can be suppressed automatically by the one-touch tuning. Furthermore, by using the vibration tough drive function, the filter is readjusted automatically when a machine resonance is detected even after the tuning.

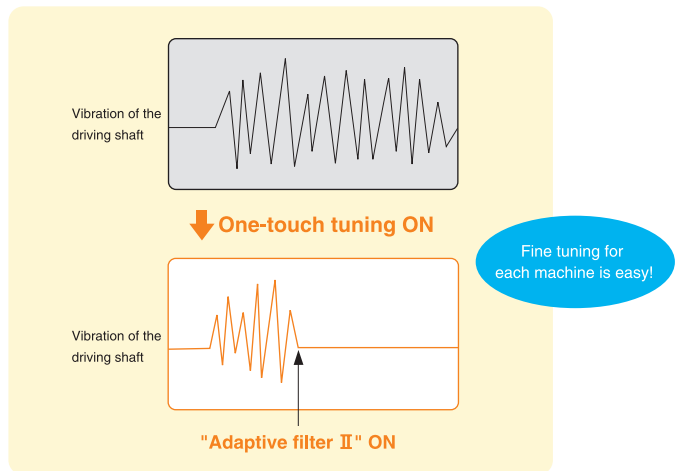

Various control modes

Speed/torque control operation

The speed control mode and the torque control mode are supported. (The speed and the torque commands are set internally by parameters.)

Switchable between the position control and the torque control!

Torque limit

The torque generated by the servo motor can be controlled by setting parameters.

Setup software "MR Configurator"

MR Configurator enables high-speed sampling and long-time waveform measurement. It makes start up and adjustments of the servo system easier. A personal computer can be connected to the servo amplifier via USB.

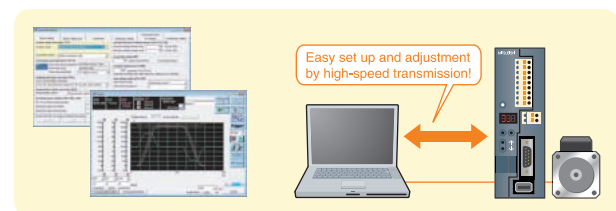

6 Conformity with Global Standards

Complied with EN, UL and CSA standards

MELSERVO-JN conforms to the global standards.

- *1. This product is not a subject of China Compulsory Certification (CCC).
- *2. HF-KN servo motor series will be compatible with EN, UL and CSA standards.

Complied with Restriction of Hazardous Substances Directive (RoHS)

MELSERVO-JN is human and environmental-friendly AC servo compliant with RoHS directive.

Additionally, our optional cables and connectors comply with "Measures for Administration of the Pollution Control of Electronic Information Products" (Chinese RoHS).

About RoHS Directive

RoHS Directive requires member nations to guarantee that new electrical and electronic equipment sold in the market after July 1, 2006 do not contain lead, cadmium, mercury, hexavalent chromium, polybrominated biphenyl (PBB) and polybrominated diphenyl ether (PBDE) flame retardants. <G> mark indicating RoHS Directive compliance is printed on the package.



Positioning operation with easiness!

MELSERVO-JN!

7 Built-in positioning function (Note 1)

■ Positioning without a controller

A simple positioning system can be configured without a controller since the positioning function (point table and program methods) is built into the servo amplifier, saving cost and space.



■ Point table method

Setting position data (target position), servo motor speed, and acceleration and deceleration time constants in the point table is as easy as setting parameters. Up to seven points are available for positioning. Positioning operation is performed after selecting the point table number with an external interface signal.

Point table setting example

Point table No.	Position data	Servo motor speed	Acceleration time constant	Deceleration time constant	Dwell time	Auxiliary function
1	1000	2000	200	200	0	1
2	2000	1600	100	100	0	0
⋮	⋮	⋮	⋮	⋮	⋮	⋮
7	3000	3000	100	100	0	2

Incremental values can be used in setting position data.

Operation example

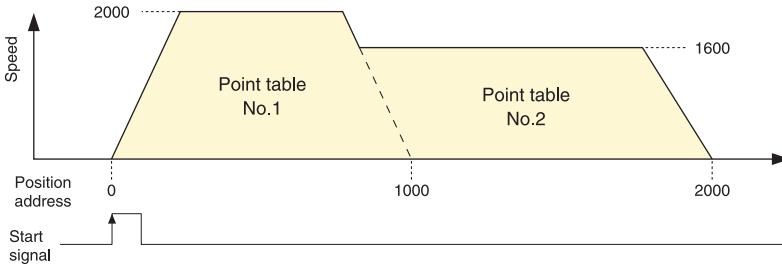

■ Program method (Note 2)

Simple positioning program can be created using dedicated commands. A program is executed with a start signal after selecting the program number with an external interface signal. Program method enables more complex positioning operation than point table method. Up to eight programs can be stored in the memory.

Program example

```

Program No. 1
SPN(3000)
STC(20)
MOV(1000)
TIM(100)
FOR(3) .....①
  MOVI(100) .....②
  TIM(100) .....③
NEXT
STOP
    
```

Operation example

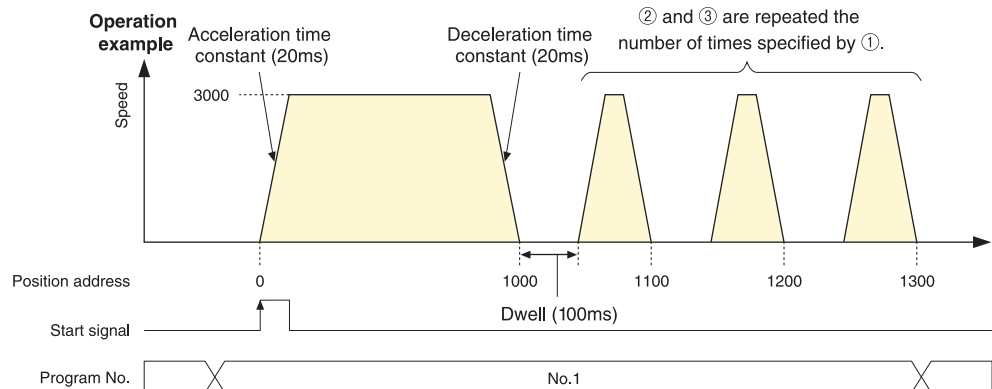

Notes: 1. Servo amplifier with software version B0 or above is required for the positioning function.

2. MR Configurator is required to create a program. MR Configurator with software version C4 or above is compatible with creating a program.

Easy to use in various situations.

MELSERVO-JN, a compact servo amplifier which enables both "high-accuracy positioning" and "speed stability in low speed" satisfies control needs in various applications.

Application examples

■ X-Y tables

For X-Y positioning system for machine tools, inspection machines, etc.

- The high-performance servo system enables high-speed positioning.
- 17-bit encoder enables high-accuracy positioning.
- Shorter tact time is achieved by suppressing vibrations.

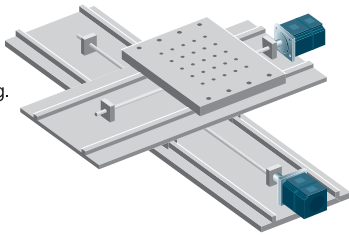

■ Conveyors

For conveyance between processes of each work, etc.

- High acceleration/deceleration and high-speed conveyance are enabled by the servo system.
- Constant-speed feed is available with a highly stable speed.
- Optimal gain can be set by the auto tuning function when using various works.

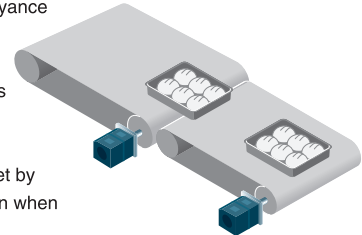

■ Food processing machines

For food processing, positioning of liquid filling nozzle, unwinding of wrapping material, etc.

- The high-performance servo system enables shorter tact time.
- The tough drive function improves machine operating rate.
- HF-KN series is rated IP65 as standard (excluding the shaft-through portion).

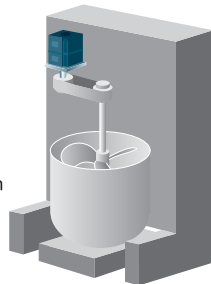

■ Loaders/unloaders, feeders and sliders

Work positioning and conveyance for automated warehouse, press machines, etc.

- The high speed and accurate positioning improves productivity.
- Compact machine can be achieved by the small-size servo amplifier and servo motor.

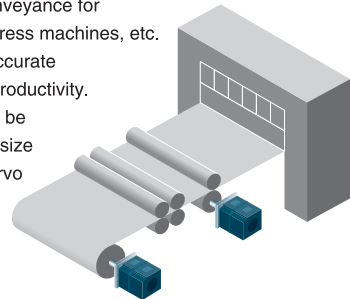

■ Textile machines

For string unwinding, traversing, etc.

- Compact machine can be achieved by the small-size servo amplifier and servo motor.
- High acceleration/deceleration and high-speed conveyance are enabled by the servo system.
- HF-KN series is rated IP65 as standard (excluding the shaft-through portion).

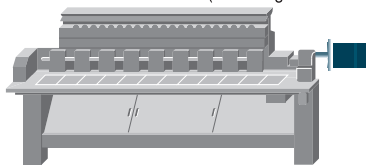

■ Robots

For picking up and transferring processing work

- Shorter tact time is achieved by suppressing vibrations.
- Optimal gain can be set by the auto tuning function when using various works.
- Compact machine can be achieved by the small-size servo amplifier and servo motor.

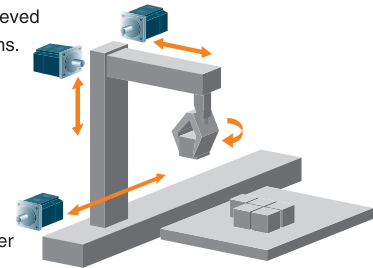

■ Semiconductor/liquid crystal/solar battery producing equipment

For peripheral axes of board, panel conveyance, etc.

- Easy maintenance with the separated power supply for main and control circuits.
- The tough drive function improves machine operating rate.
- Compact machine can be achieved by the small-size servo amplifier and servo motor.

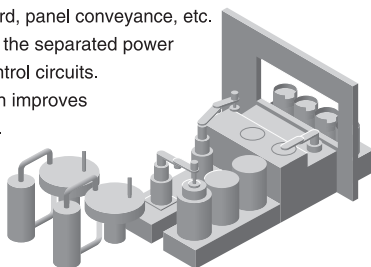

■ Replacement of stepping motors, DC motors, air actuator or inverters

By introducing the servo system, the driving section of the legacy products can be faster and more accurate.

- Replacement of the air actuator enables more accurate driving section.
- Step-out occurred with the stepping motor is no longer an issue.
- Replacement of the inverter improves speed and accuracy.

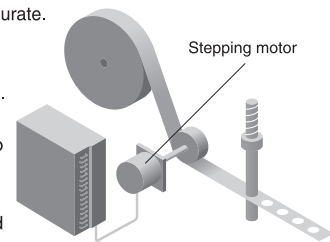

Servo Support Software (Easy introduction support)

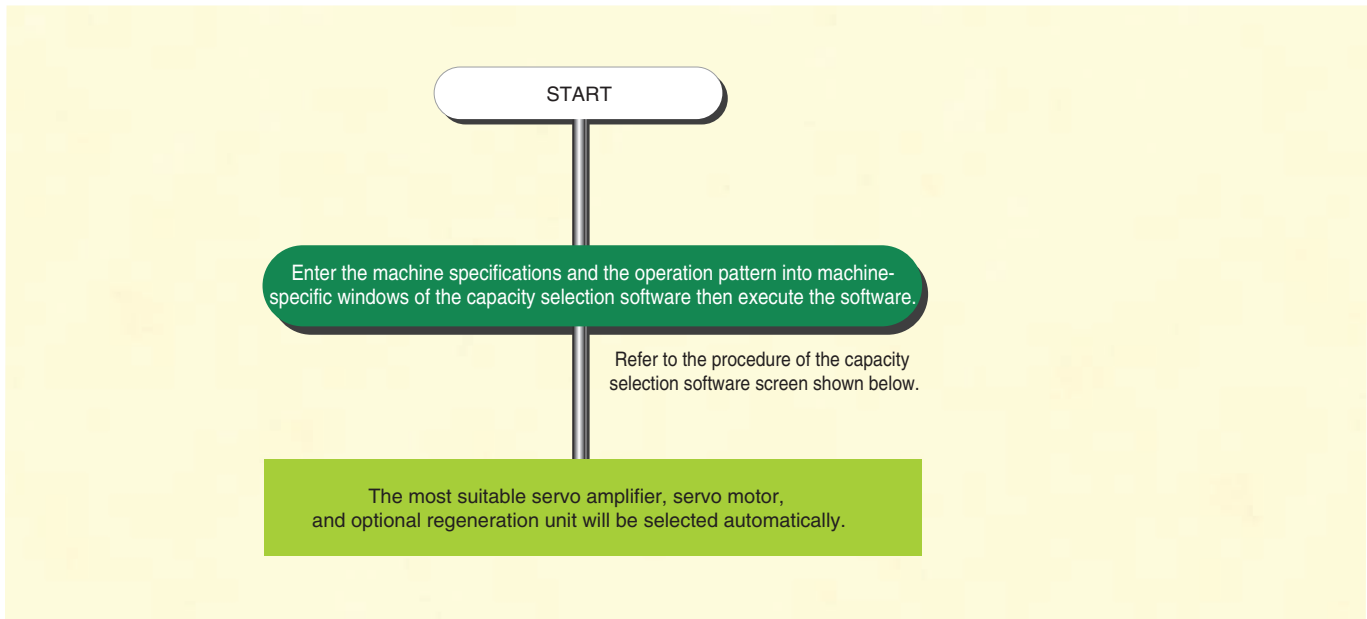

Capacity selection software

● MRZJW3-MOTZ111E

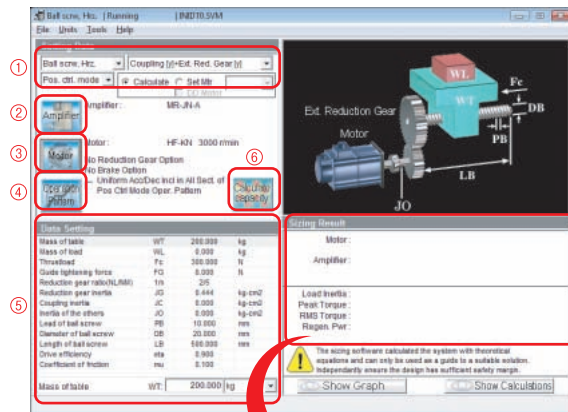

You don't need complex calculations anymore by using the capacity selection software (MRZJW3-MOTZ111E).

Machine-specific windows which apply to each machine are prepared. The most suitable servo amplifier, servo motor (including the one with electromagnetic brake or with reducer), and optional regeneration unit can be selected automatically just by entering the constants and the operation pattern of the machine.

● Features

- (1) User-defined operation patterns can be set. The operation pattern can be selected from the position control mode operation or speed control mode operation. The selected operation pattern can be also displayed in the graph.
- (2) The feedrate (or motor speed) and torque can be displayed in the graph during the selection process.

* For details of the specifications, refer to p.36 of this catalog.

*These are reference screens. They may differ from the actual screens.

- ① Select the type of the machine.
- ② Click the "Amplifier" button and select "MR-JN".
- ③ Click the "Motor" button and select the motor.
- ④ Click the "Operation pattern" button to create the operation pattern.
- ⑤ Input the specifications of the machine.
- ⑥ Click the "Calculate capacity" button.
- ⑦ The selected servo amplifier/servo motor model will be displayed.

Note: Capacity selection software (MRZJW3-MOTZ111E) is available for free download. Contact your local sales office for more details.

Servo Support Software (Easy setup support)

MR Configurator

● MRZJW3-SETUP221E (Setup software)

The MR Configurator makes it easy to perform, tuning, monitor display, diagnostics, reading and writing parameters, and test operations with a personal computer. This software realizes a stable machine system, optimum control and short setup time.

● Features

- (1) This software allows easy set up and tuning of the servo system with a personal computer.
- (2) Multiple monitor functions
Graphic display functions are provided to display the servo motor status with the input signal triggers, such as the command pulse, droop pulse and speed.
- (3) Test operations with a personal computer
Test operation of the servo motors can be performed with a personal computer using multiple test mode menus.

* For details of the specifications, refer to p.36 of this catalog.



[Parameter setting] window

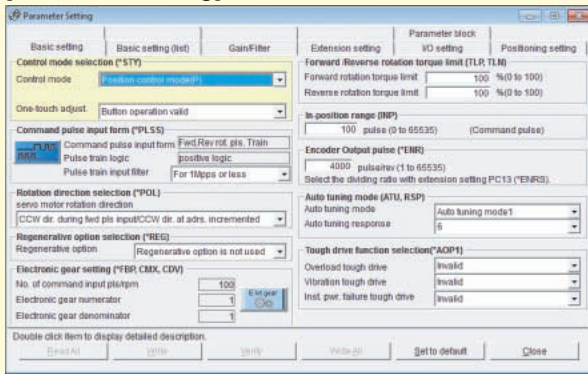

The basic setting parameters can be easily set in a selection format. Settings in the list format are also possible.

[Monitor] function:
[Amplifier Data Display] window

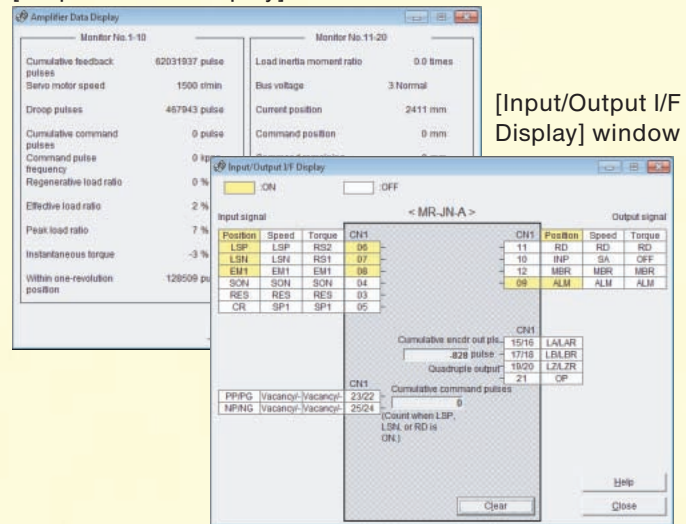

[Input/Output I/F Display] window

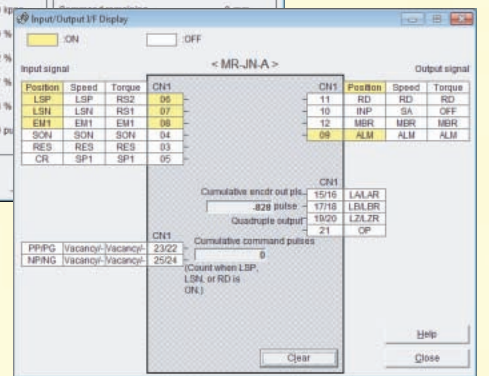

The [Input/Output I/F Display] window and [Amplifier Data Display] window can be displayed simultaneously, so the DI/DO ON/OFF status and operation status can be checked in real time.

[Test mode menu] window

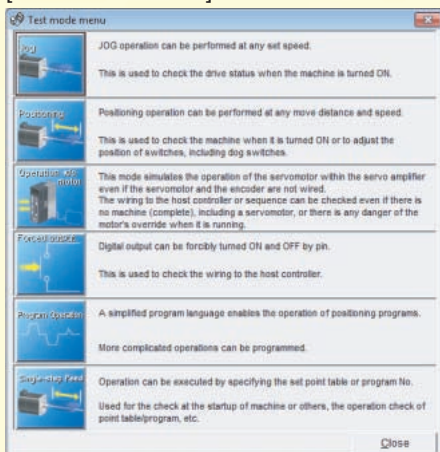

The test operation that matches the application can be selected from the multiple test mode menus.

[Graph] window

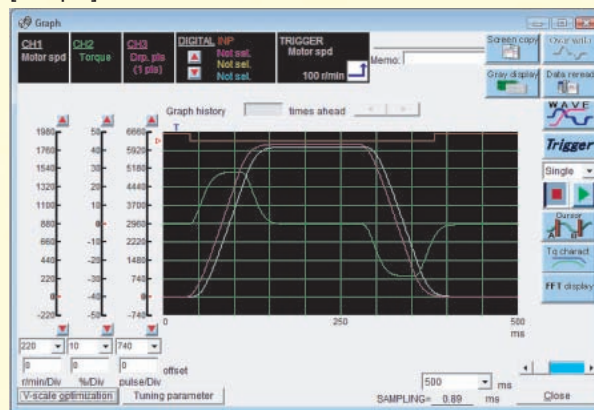

Powerful graph functions with 3 analog channels and 4 digital channels support tuning. User-friendly functions such as [Over write] and [Graph history] and a diverse waveform selection powerfully support user's work. Also, the [Gray display] function is provided for easy reading of printed data. Data can be saved either in CSV or JPEG format.

Note: The screens on this page are for reference. They may differ from the actual screens.

Servo amplifiers

Servo motors

Options

Peripheral Equipment

Servo Support Software

Dimensions

Cautions

Model Designation

● Servo amplifiers

MR-JN - 10 A

Mitsubishi general-purpose
AC servo amplifier
MELSERVO-JN series

List of
compatible servo motors

Symbol	200VAC class	
	HF-KN	HF-KP (with reducer)
10	053, 13	053, 13
20	23	23
40	43	43

Symbol	Power supply
None	1-phase 200VAC
1	1-phase 100VAC (Note 1)

Notes: 1. MR-JN-10A1 and -20A1 are available.

A: General-purpose interface

● HF-KN series servo motors

HF-KN 05 3 B

Symbol	Servo motor series
HF-KN	Low inertia, small capacity

Symbol	Rated output (kW)
05	0.05
1	0.1
2	0.2
4	0.4

Note: HF-KN series does not have a geared servo motor. The geared servo motor is available in HF-KP series.

Symbol	Electromagnetic brake
None	None
B	Installed

Note: Refer to "Electromagnetic Brake Specifications" in this catalog for detailed specifications.

Symbol	Rated speed (r/min)
3	3000

Symbol	Shaft end
None	Standard (straight shaft)
K	With key (Note 1)
D	D-cut (Note 1)

Notes: 1. Refer to "Special Shaft End Specifications" in this catalog for the available models and detailed specifications.

* The servo motors above are under application for EN, UL and CSA standards. Contact your local sales office for more details.

● HF-KP series geared servo motors

HF-KP 05 3 B

Symbol	Servo motor series
HF-KP	Low inertia, small capacity

Symbol	Rated output (kW)
05	0.05
1	0.1
2	0.2
4	0.4

Symbol	Rated speed (r/min)
3	3000

Symbol	Reducer
G1	For general industrial machines
G5	Flange output type for precision application, flange mounting
G7	Shaft output type for precision application, flange mounting

Note: Refer to "Geared Servo Motor Specifications" in this catalog for the available model and detailed specifications.

Symbol	Electromagnetic brake
None	None
B	Installed

Note: Refer to "Electromagnetic Brake Specifications" in this catalog for the available models and detailed specifications.

Symbol	Shaft end
None	Standard (straight shaft)
K	With key (Note 1)

Notes: 1. Refer to "Special Shaft End Specifications" in this catalog for the available models and detailed specifications.

Connections with Peripheral Equipment (Note 1)

Peripheral equipment is connected to MR-JN-□A as described below. Connectors, options, and other necessary equipment are available so that users can set up MR-JN-□A easily and begin using it right away.

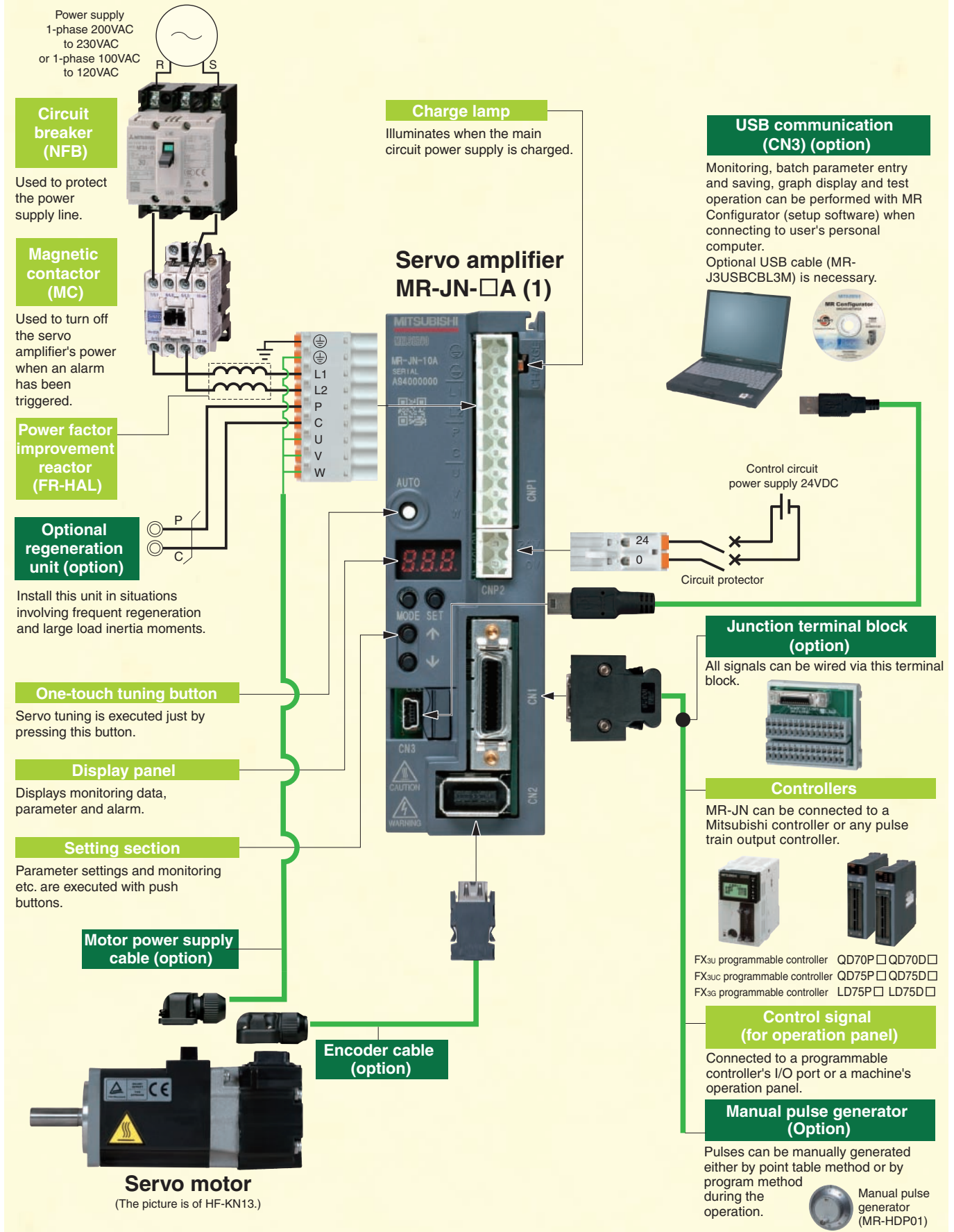

Servo amplifiers
Servo motors
Options
Peripheral Equipment
Servo Support Software
Dimensions
Cautions

Notes: 1. Refer to "MR-JN-□A INSTRUCTION MANUAL" for the actual connections.

Servo Amplifier Specifications

Servo amplifier model		MR-JN-10A	MR-JN-20A	MR-JN-40A	MR-JN-10A1	MR-JN-20A1
Output	Rated voltage	3-phase 170VAC				
	Rated current (A)	1.1	1.6	2.8	1.1	1.6
Main circuit power supply	Voltage/frequency (Note 1, 2)	1-phase 200VAC to 230VAC 50/60Hz			1-phase 100VAC to 120VAC 50/60Hz	
	Rated current (A)	1.5	2.4	4.5	3.0	5.0
	Permissible voltage fluctuation	1-phase 170VAC to 253VAC			1-phase 85VAC to 132VAC	
	Permissible frequency fluctuation	±5% maximum				
Control circuit power supply	Voltage	24VDC				
	Rated current (A)	0.5				
	Permissible voltage fluctuation	±10% maximum				
	Power consumption (W)	10				
Interface power supply		24VDC ±10% (required current capacity: 0.2A (Note 5))				
Tolerable regenerative power of built-in regenerative resistor (W) (Note 3, 4)		—	10	10	—	10
Control system		Sine-wave PWM control/current control system				
Dynamic brake		Built-in (Note 6)				
Safety features		Overcurrent shutdown, regeneration overvoltage shutdown, overload shutdown (electronic thermal), servo motor overheat protection, encoder fault protection, regeneration fault protection, undervoltage/sudden power outage protection, overspeed protection, excess error protection				
Position control mode	Maximum input pulse frequency	1Mpps (when using differential receiver), 200kpps (when using open collector)				
	Positioning feedback pulse	Encoder resolution: 131072 p/rev				
	Command pulse multiple	Electronic gear A/B multiple, A: 1 to 65535, B: 1 to 65535, 1/50 < A/B < 500				
	Positioning complete width setting	0 to ± 65535 pulses (command pulse unit)				
	Excess error	± 3 rotations				
	Torque limit	Set by parameters				
Internal speed control mode	Speed control range	Internal speed command 1:5000				
	Speed command input	Set by parameters				
	Speed fluctuation rate	± 0.01% maximum (load fluctuation 0 to 100%) 0% (power fluctuation ± 10%)				
	Torque limit	Set by parameters				
Internal torque control mode	Torque command input	Set by parameters				
	Speed limit	Set by parameters				
Positioning mode (Note 8)		Point table method, Program method				
Structure		Natural-cooling open (IP rating: IP20)				
Environment	Ambient temperature (Note 7)	0 to 55°C (32 to 131°F) (non freezing), storage: -20 to 65°C (-4 to 149°F) (non freezing)				
	Ambient humidity	90% RH maximum (non condensing), storage: 90% RH maximum (non condensing)				
	Atmosphere	Indoors (no direct sunlight); no corrosive gas, inflammable gas, oil mist or dust				
	Elevation	1000m or less above sea level				
	Vibration	5.9m/s ² or less at 10 to 55Hz (directions of X, Y and Z axes)				
Mass (kg [lb])		0.6 (1.3)	0.6 (1.3)	0.7 (1.5)	0.6 (1.3)	0.6 (1.3)

- Notes: 1. Rated output and speed of a servo motor are applicable when the servo amplifier, combined with the servo motor, is operated within the specified power supply voltage and frequency. Torque drops when the power supply voltage is below the specified value.
2. For torque characteristics when combined with a servo motor, refer to "Servo Motor Torque Characteristics" in this catalog.
3. Optimal regenerative resistor varies for each system. Select the most suitable regenerative resistor by using the capacity selection software.
4. Refer to "Options ● Optional regeneration unit" in this catalog for the tolerable regenerative power (W).
5. 0.2A is the value when all of the input/output points are used. The current capacity can be stepped down according to the number of input/output points in use. Refer to "MR-JN-□A INSTRUCTION MANUAL" for details.
6. When using the built-in dynamic brake, refer to "MR-JN-□A INSTRUCTION MANUAL" for the permissible load to motor inertia moment ratio.
7. The servo amplifier can be installed closely. In this case, keep the ambient temperature within 0 to 45°C (32 to 113°F), or use the servo amplifier at 75% or less of the effective load rate.
8. Servo amplifier with software version B0 or above is required for the positioning function.

Standard Wiring Diagram: Position Control Operation

● Connection example to FX3u

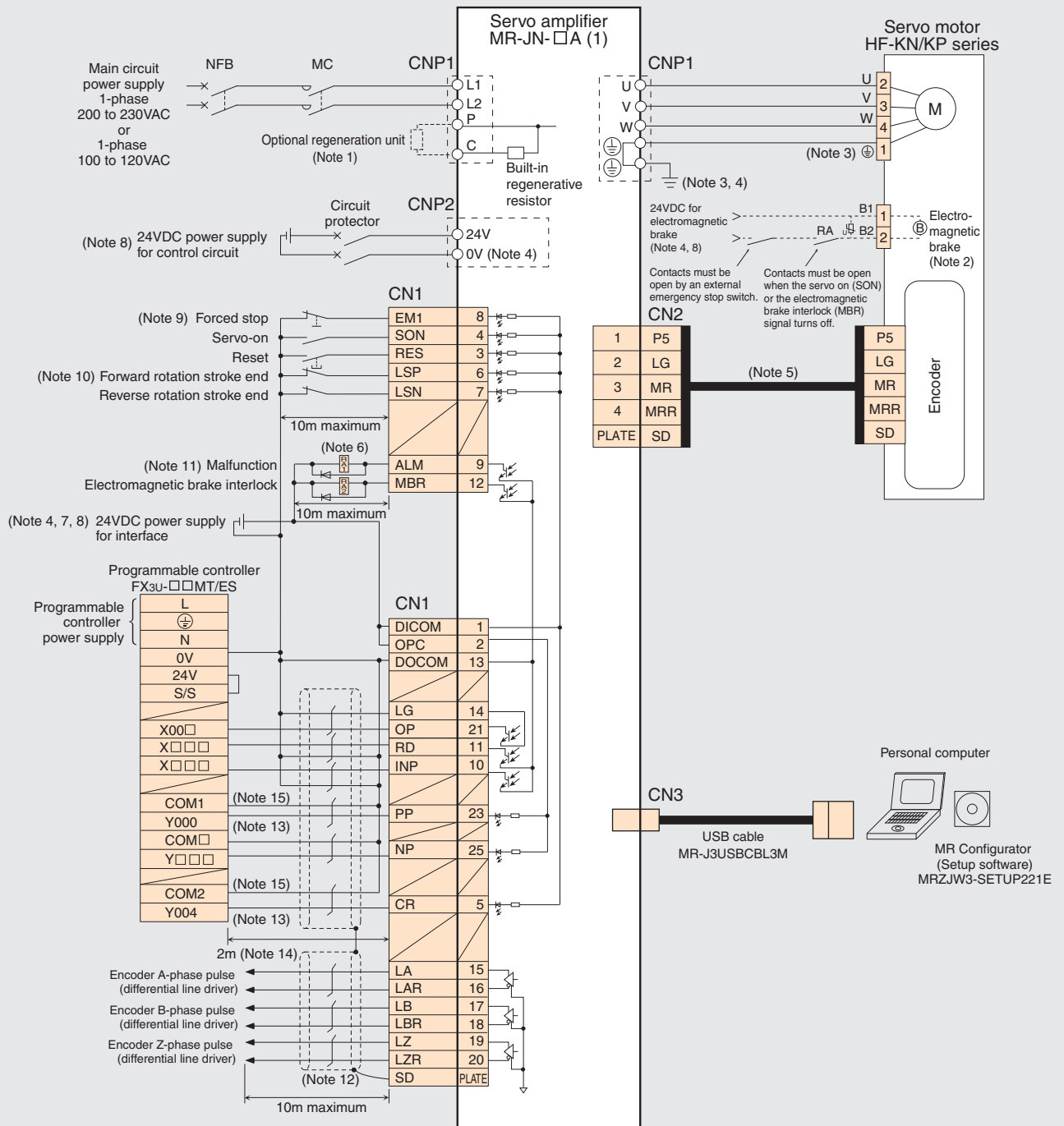

- Notes:
1. Disconnect the wires for the built-in regenerative resistor (P and C) and remove the resistor from the servo amplifier when connecting the optional regeneration unit externally.
 2. This is for the servo motor with electromagnetic brake. The electromagnetic brake terminals (B1, B2) do not have polarity.
 3. Connect the ground wire to the cabinet protective earth (PE) terminal via the servo amplifier protective earth (PE) terminal for grounding.
 4. Do not connect the 0V of 24VDC power supply to the servo amplifier protective earth (PE) terminal.
 5. The signals shown are applicable when using a two-wire type encoder cable. Refer to "MR-JN-□A INSTRUCTION MANUAL" for four-wire type.
 6. Do not reverse the diode's direction. Connecting it backwards may cause the servo amplifier to malfunction such that the signals are not output, and the forced stop and other safety circuits are inoperable.
 7. Use the power supply 24VDC±10% (required current capacity: 0.2A). 0.2A is the value when all of the input/output points are used.
Note that the current capacity can be stepped down according to the number of input/output points in use. Refer to "MR-JN-□A INSTRUCTION MANUAL" for details.
 8. Use the enhanced insulation power supply for the external power supply 24VDC. Do not use the 24VDC interface and control circuit power supplies for the electromagnetic brake. Provide a power supply designed exclusively for the electromagnetic brake.
 9. Always turn on the forced stop (EM1) signal (normally closed contact) before starting the operation. If not, the operation will not start.
 10. Always turn on the forward and reverse rotation stroke end (LSP/LSN) signals (normally closed contact) before starting the operation. If not, the commands will not be accepted.
 11. The malfunction (ALM) signal (normally closed contact) is conducted to DOCOM in normal alarm-free condition.
 12. Connect the shield wire securely to the plate inside the connector (ground plate).
 13. This is applicable when the setting of the programmable controller is for the first axis. For the second or third axis, the number changes.
 14. It is recommended that the connection be 2m or shorter because an open-collector system is used.
 15. Signal names are different for FX3u-16MT/ES: COM1 will be COM0 and COM2 will be COM4.

Standard Wiring Diagram: Position Control Operation

● Connection example to QD75D

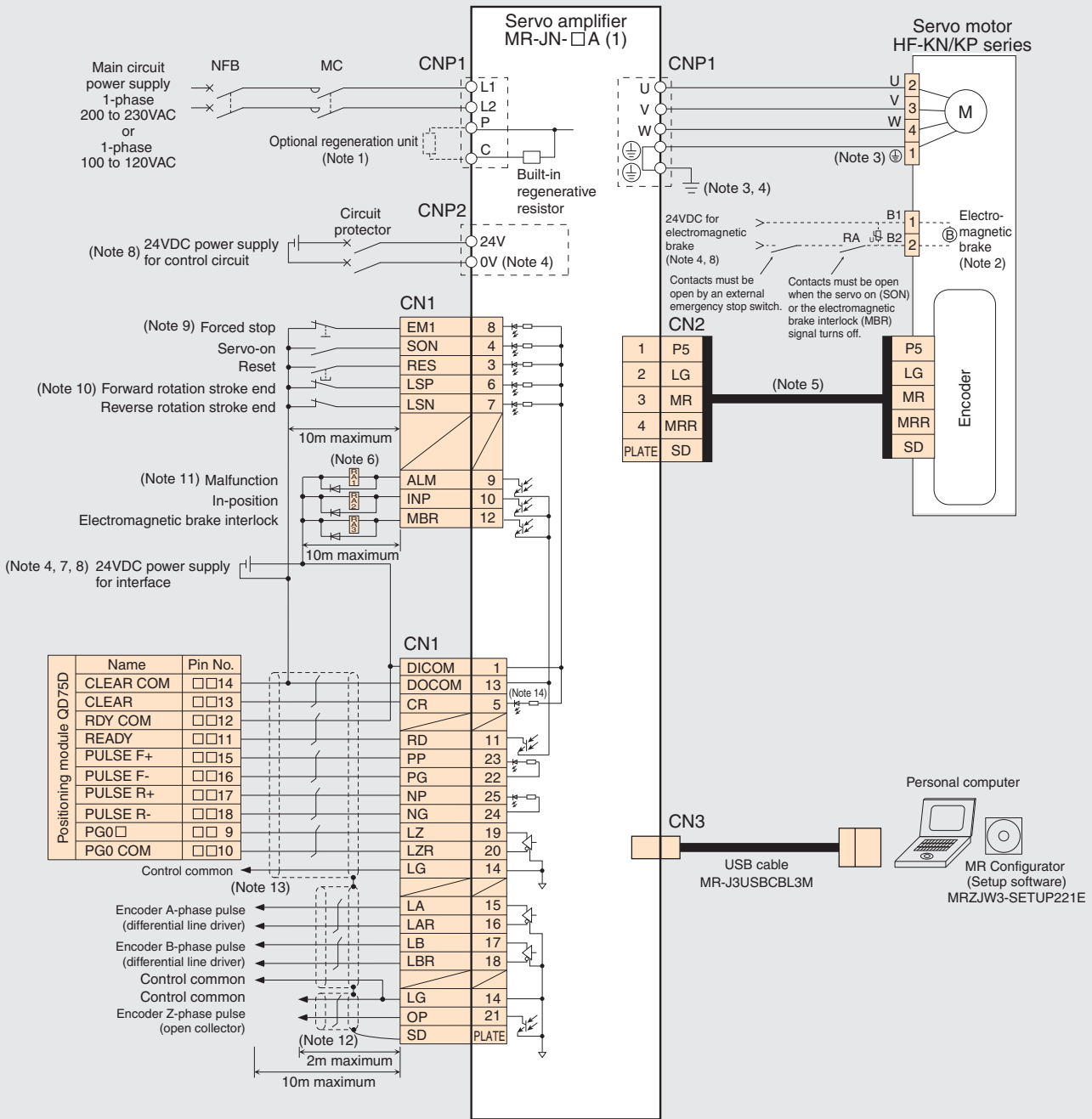

Standard Wiring Diagram: Speed Control Operation (Note 1)

● Connection example

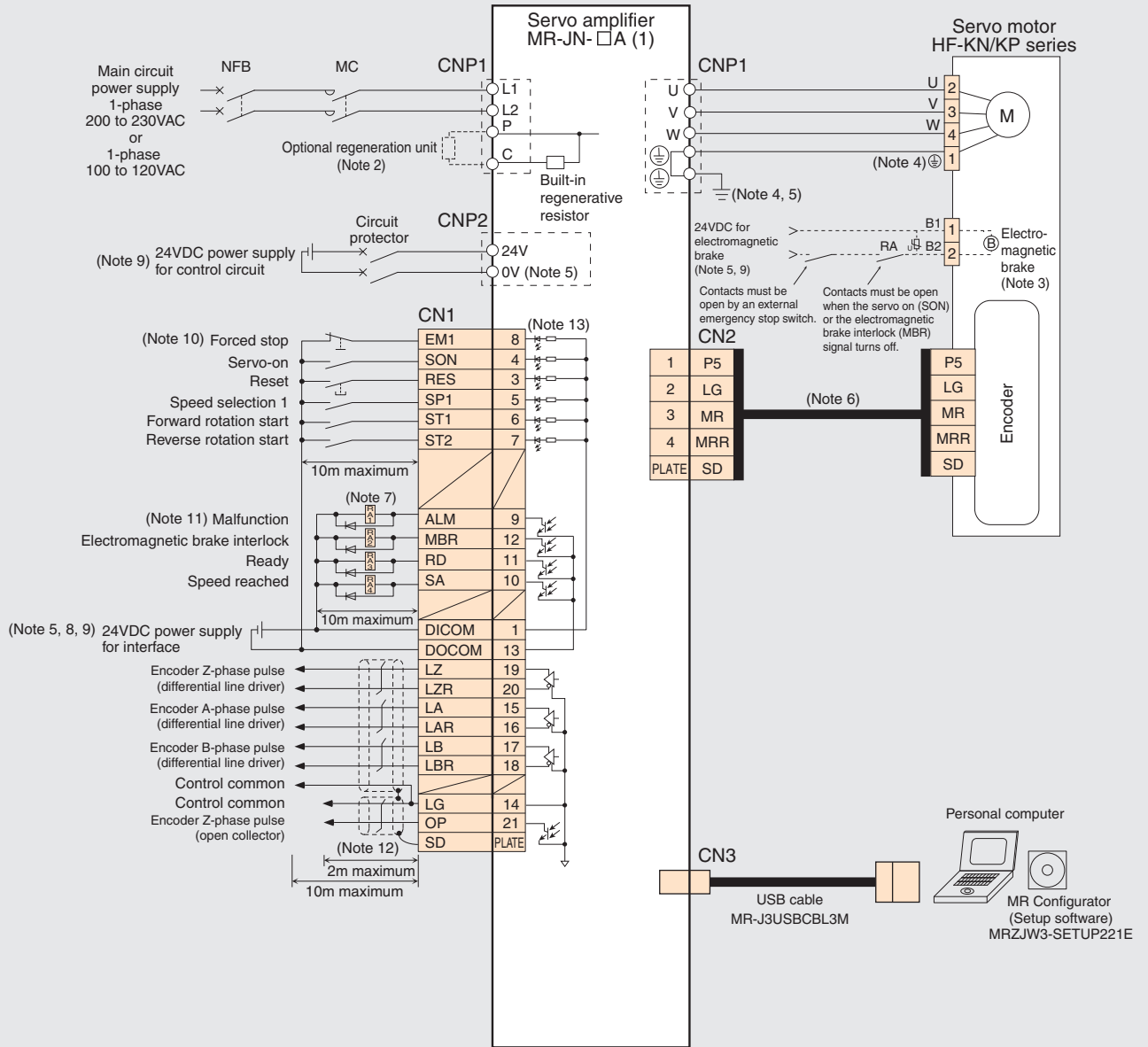

Servo amplifiers

Servo motors

Options

Peripheral Equipment

Servo Support Software

Dimensions

Cautions

Standard Wiring Diagram: Torque Control Operation (Note 1)

● Connection example

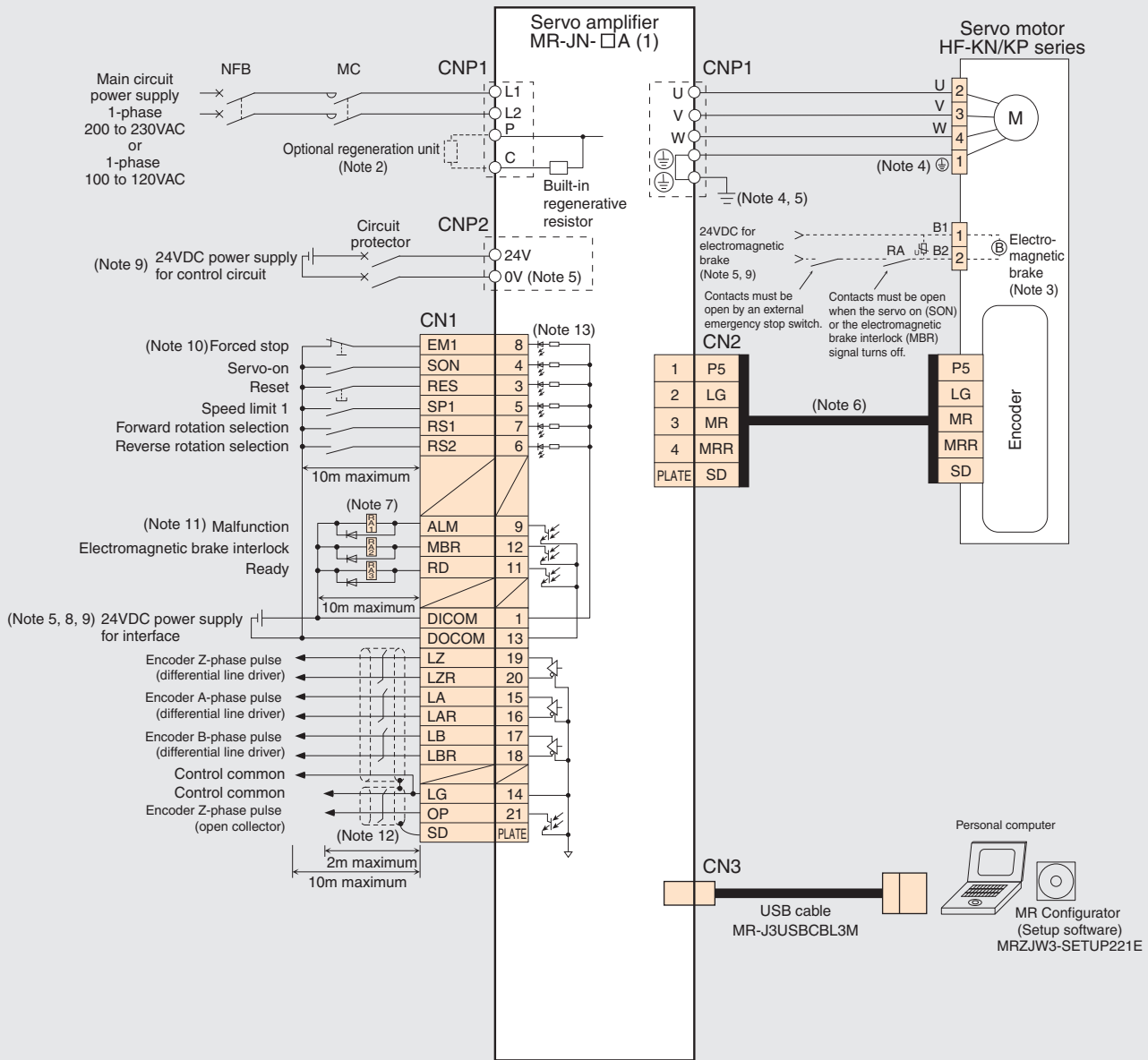

Notes: 1. MR-JN-□A supports only operations by internal torque command.

2. Disconnect the wires for the built-in regenerative resistor (P and C) and remove the resistor from the servo amplifier when connecting the optional regeneration unit externally.
3. This is for the servo motor with electromagnetic brake. The electromagnetic brake terminals (B1, B2) do not have polarity.
4. Connect the ground wire to the cabinet protective earth (PE) terminal via the servo amplifier protective earth (PE) terminal for grounding.
5. Do not connect the 0V of 24VDC power supply to the servo amplifier protective earth (PE) terminal.
6. The signals shown are applicable when using a two-wire type encoder cable. Refer to "MR-JN-□A INSTRUCTION MANUAL" for four-wire type.
7. Do not reverse the diode's direction. Connecting it backwards may cause the servo amplifier to malfunction such that the signals are not output, and the forced stop and other safety circuits are inoperable.
8. Use the power supply 24VDC \pm 10% (required current capacity: 0.2A). 0.2A is the value when all of the input/output points are used. Note that the current capacity can be stepped down according to the number of input/output points in use. Refer to "MR-JN-□A INSTRUCTION MANUAL" for details.
9. Use the enhanced insulation power supply for the external power supply 24VDC. Do not use the 24VDC interface and control circuit power supplies for the electromagnetic brake. Provide a power supply designed exclusively for the electromagnetic brake.
10. Always turn on the forced stop (EM1) signal (normally closed contact) before starting the operation. If not, the operation will not start.
11. The malfunction (ALM) signal (normally closed contact) is conducted to DOCOM in normal alarm-free condition.
12. Connect the shield wire securely to the plate inside the connector (ground plate).
13. This is for sink wiring. Source wiring is also possible. Refer to "MR-JN-□A INSTRUCTION MANUAL" for details.

Positioning function: Point table method (Note 1)

Set position and speed data in the point table beforehand.

Positioning operation is performed after selecting the point table number with an external interface signal.

Point table: The following two types of point tables are available.

(1) Absolute value command method:

Moves to the address (absolute value) based on the home position.

Item	Setting range	Unit	Description
Position data	-999999 to 999999	$\times 10^{STM} \mu\text{m}$	<ul style="list-style-type: none"> Absolute value command method Sets the address. STM is the ratio for the data. Incremental value command method Sets the movement amount. STM is the ratio for the data.
Servo motor speed	0 to permissible	r/min	Sets the command speed for the servo motor used for positioning.
Acceleration time constant	0 to 20000	ms	Sets the acceleration time constant. (Note 2)
Deceleration time constant	0 to 20000	ms	Sets the deceleration time constant. (Note 2)
Dwell time	0 to 20000	ms	Runs the next point table after the set dwell time.
Auxiliary function	0 to 3	—	<ul style="list-style-type: none"> Absolute value command method 0: Positions and stops (waits for start signal). 1: Continues operation for the next point table without stopping. Incremental value command method 2: Positions and stops (waits for start signal). 3: Continues operation for the next point table without stopping.

(Example of setting point table data)

Point table No.	Position data	Servo motor speed	Acceleration time constant	Deceleration time constant	Dwell time	Auxiliary function
1	1000	2000	200	200	0	1
2	2000	1600	100	100	0	0
:	:	:	:	:	:	:
7	3000	3000	100	100	0	2

If the point table No.1's auxiliary function is 1 or 3, continuous positioning operation is carried out based on the point table as shown in the "●Auxiliary function 1 or 3" below.

If the point table No.1's auxiliary function is 0 or 2, a start signal must be issued as shown in "●Auxiliary function 0 or 2" below.

● Auxiliary function 1 or 3

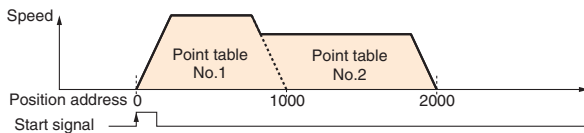

● Auxiliary function 0 or 2

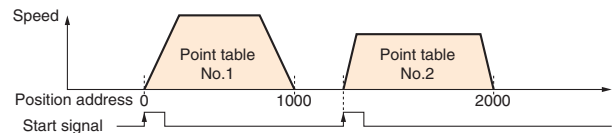

(2) Incremental value command method:

Moves from the current value according to the set position data

Item	Setting range	Unit	Description
Position data	0 to 999999	$\times 10^{STM} \mu\text{m}$	Sets the movement amount. STM is the ratio for the data.
Servo motor speed	0 to permissible	r/min	Sets the command speed for the servo motor used for positioning.
Acceleration time constant	0 to 20000	ms	Sets the acceleration time constant. (Note 2)
Deceleration time constant	0 to 20000	ms	Sets the deceleration time constant. (Note 2)
Dwell time	0 to 20000	ms	Runs the next point table after the set dwell time.
Auxiliary function	0 and 1	—	<ul style="list-style-type: none"> 0: Positions and stops (waits for start signal). 1: Continues operation for the next point table without stopping.

(Example of setting point table data)

Point table No.	Position data	Servo motor speed	Acceleration time constant	Deceleration time constant	Dwell time	Auxiliary function
1	1000	2000	200	200	0	1
2	1000	1600	100	100	0	0
:	:	:	:	:	:	:
7	500	3000	100	100	0	0

If the point table No.1's auxiliary function is 1, continuous positioning operation is carried out based on the point table as shown in the "●Auxiliary function 1" below.

If the point table No.1's auxiliary function is 0, a start signal must be issued as shown in "●Auxiliary function 0" below.

● Auxiliary function 1

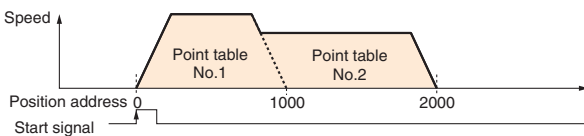

● Auxiliary function 0

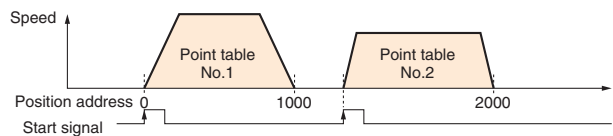

Notes: 1. Servo amplifier with software version B0 or above is required for the positioning function.

2. S-pattern acceleration/deceleration time constant is set by the servo amplifier's parameter.

Positioning Function: Point Table Method

● Command and Operation Mode

Item		Description	
Command method	Point table No. input	Command interface	DIO (Note 1)
		Operating specification	Positions according to the specification of the point table No. (7 points)
		Input positioning command	Set in point table. One-point feed length setting range: $\pm 1\mu\text{m}$ to $\pm 999999 \times 10^{\text{STM}} \mu\text{m}$. (Note 2)
		System	Signed absolute value command system, increment value command system
Operation mode	Automatic operation mode	Point table	Point table number input Each positioning operation based on position and speed commands.
		Manual operation mode	JOG
	Manual pulse generator		Manual feed by manual pulse generator. Command pulse multiplication: $\times 1$, $\times 10$ or $\times 100$ is selectable by the parameter.
	Home position return mode	Dog type	Returns to home position upon Z-phase pulse count after passing through proximity dog. Direction for return to home position selectable. Home position shift amount and home position address settable. Automatic retreat on dog back to home position and automatic stroke retreat function.
		Count type	Returns to home position upon Z-phase pulse count after touching proximity dog. Direction for return to home position selectable. Home position shift amount and home position address settable. Automatic retreat on dog back to home position and automatic stroke retreat function.
		Data set type	Returns to home position without dog. Sets any position as home position using manual operation, etc. Home position address settable.
		Stopper type	Returns to home position upon hitting end of stroke. Direction for return to home position selectable. Home position address settable.
		Ignore home (Servo-on position as home position)	Uses position where the servo on (SON) signal turns ON as home position. Home position address settable.
		Dog type rear end reference	Returns to home position with respect to the rear end of a proximity dog. Direction for return to home position selectable. Home position shift amount and home position address settable. Automatic retreat on dog back to home position and automatic stroke retreat function.
		Count type front end reference	Returns to home position with respect to the front end of a proximity dog. Direction for return to home position selectable. Home position shift amount and home position address settable. Automatic retreat on dog back to home position and automatic stroke retreat function.
Dog cradle type		Returns to home position upon the first Z-phase pulse with respect to the front end of a proximity dog. Direction for return to home position selectable. Home position shift amount and home position address settable. Automatic retreat on dog back to home position and automatic stroke retreat function.	

Notes: 1. The command interface will be compatible with pulse train command by using manual pulse generator (MR-HDP01).

2. STM is the ratio for the data. It can be changed by parameter.

● Connection example

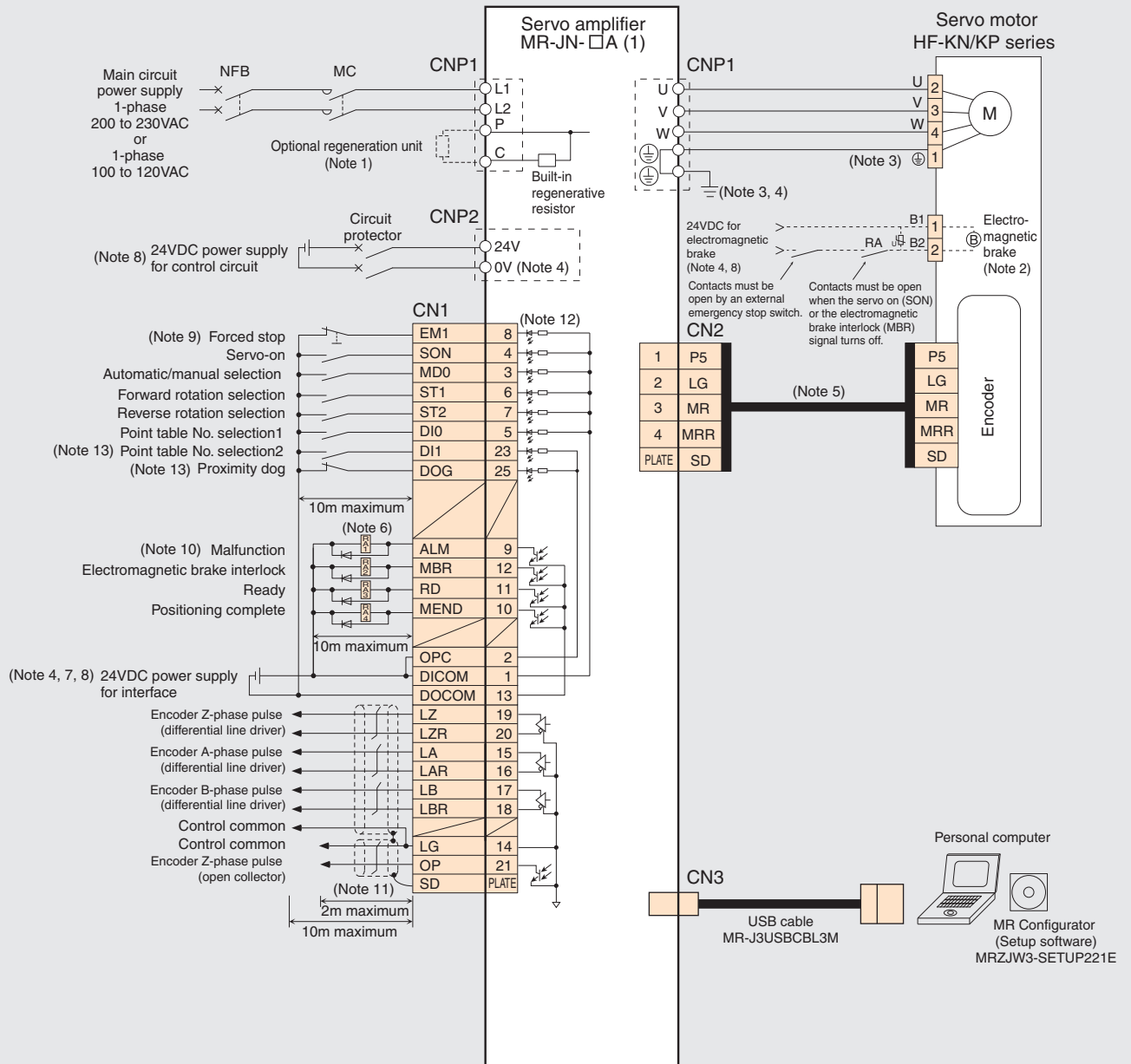

Servo amplifiers

Servo motors

Options

Peripheral Equipment

Servo Support Software

Dimensions

Cautions

Positioning function: Program method (Note 8)

Create position data, servo motor speed, acceleration and deceleration time constants and so on as programs beforehand. Positioning operation is performed by selecting the created Program No. with an external interface signal. Program method enables more complex positioning operation than point table method. MR Configurator (Setup software) is required to create a program. (Note 7)

● Command list (Note 6)

Command	Name	Setting	Setting range	Unit	Description
SPN (Note 1)	Servo motor speed	SPN (setting)	0 to permissible speed	r/min	Sets the command speed of the servo motor for positioning. The setting value must not exceed the permissible speed of the servo motor used.
STA (Note 2)	Acceleration time constant	STA (setting)	0 to 20000	ms	Sets the acceleration time constant.
STB (Note 2)	Deceleration time constant	STB (setting)	0 to 20000	ms	Sets the deceleration time constant.
STC (Note 2)	Acceleration and deceleration time constants	STC (setting)	0 to 20000	ms	Sets the acceleration and deceleration time constants.
STD (Note 2)	S-pattern acceleration and deceleration time constants	STD (setting)	0 to 100	ms	Sets the S-pattern acceleration and deceleration time constants.
MOV	Absolute value move command	MOV (setting)	-999999 to 999999	$\times 10^{\text{STM}}$ μm (Note 5)	Moves according to the value set as an absolute value.
MOVA	Absolute value continuous move command	MOVA (setting)	-999999 to 999999	$\times 10^{\text{STM}}$ μm (Note 5)	Moves continuously according to the value set as an absolute value. Be sure to use this command together with the [MOV] command.
MOVI	Incremental value move command	MOVI (setting)	-999999 to 999999	$\times 10^{\text{STM}}$ μm (Note 5)	Moves according to the value set as an incremental value.
MOVIA	Incremental value continuous move command	MOVIA (setting)	-999999 to 999999	$\times 10^{\text{STM}}$ μm (Note 5)	Moves continuously according to the value set as an incremental value. Be sure to use this command together with the [MOVI] command.
SYNC (Note 3)	Waiting for external signal to switch ON	SYNC (setting)	1	—	Stops the next step until the program input 1 (PI1) is turned ON after the synchronous output (SOUT) command is output.
OUTON (Note 3)	External signal ON output	OUTON (setting)	1	—	Turns ON the program output 1 (OUT1).
OUTOF (Note 3)	External signal OFF output	OUTOF (setting)	1	—	Turns OFF the program output 1 (OUT1) which was turned ON by the [OUTON] command.
TRIP (Note 3)	Absolute value passage point specification	TRIP (setting)	-999999 to 999999	$\times 10^{\text{STM}}$ μm (Note 5)	When the motor passes through the current position set, the next step is executed.
TRIP1 (Note 3)	Incremental value passage point specification	TRIP1 (setting)	-999999 to 999999	$\times 10^{\text{STM}}$ μm (Note 5)	When the motor moves for the moving distance set by the [TRIP1] command after the [MOVI] and/or [MOVIA] commands is performed, the next step is executed. Be sure to write this command after the [MOVI] and/or [MOVIA] commands.
ITP (Note 3, 4)	Interrupt positioning	ITP (setting)	0 to 999999	$\times 10^{\text{STM}}$ μm (Note 5)	When the interrupt signal is ON, the motor moves for the distance set by this command, and it stops. Use this command after the [SYNC] command in combination.
COUNT (Note 3)	External pulse count	COUNT (setting)	-999999 to 999999	pulse	When the value of the pulse counter exceeds the count value set in the [COUNT] command, the next step is executed. Setting [COUNT (0)] clears the pulse counter to zero.
FOR NEXT	Step repeat command	FOR (setting) NEXT	0, 1 to 10000	times	Repeats the steps between [FOR (setting value)] and [NEXT] commands for the number of times set. If zero is set, the steps are repeated unlimitedly.
TIM	Dwell	TIM (setting)	1 to 20000	ms	Waits for the next step until the set time passes.
ZRT	Home position return	ZRT	—	—	Executes a manual home position return.
TIMES	Program count command	TIMES (setting)	0, 1 to 10000	times	Sets the number of program execution by writing [TIMES (setting value)] command on the beginning of the program. If zero is set, the program is repeated unlimitedly.
STOP	Program stop	STOP	—	—	Stops the program being executed. Be sure to write this command in the final line.

- Notes: 1. The [SPN] command is valid when the [MOV], [MOVA], [MOVI], or [MOVIA] command is executed.
 2. The [STA], [STB], [STC], and [STD] commands are valid when the [MOV] or [MOVI] command is executed.
 3. The [SYNC], [OUTON], [OUTOF], [TRIP], [TRIP1], [ITP], and [COUNT] commands are valid even while an instruction is output.
 4. If the remaining distance equals to the setting value or less, the servo motor is not running, or the servo motor is decelerating, the [ITP] command is skipped and control goes to the next step.
 5. STM is the ratio for the data. It can be changed by parameter.
 6. For the content of each command, refer to "MR-JN-□A INSTRUCTION MANUAL".
 7. MRZJW3-SETUP221E with software version C4 or above is compatible with creating a program.
 8. Servo amplifier with software version B0 or above is required for the positioning function.

Positioning Function: Program Examples

Example 1

When executing two types of operations which have the same servo motor speed, the same acceleration and deceleration time constants and the different move commands:

Program	Description
SPN (3000)	Servo motor speed 3000 (r/min) ①
STA (200)	Acceleration time constant 200 (ms) ②
STB (300)	Deceleration time constant 300 (ms) ③
MOV (1000)	Absolute value move command 1000 ($\times 10^{\text{STM}} \mu\text{m}$) ④
TIM (100)	Dwell 100 (ms) ⑤
MOV (2500)	Absolute value move command 2500 ($\times 10^{\text{STM}} \mu\text{m}$) ⑥
STOP	Program stop

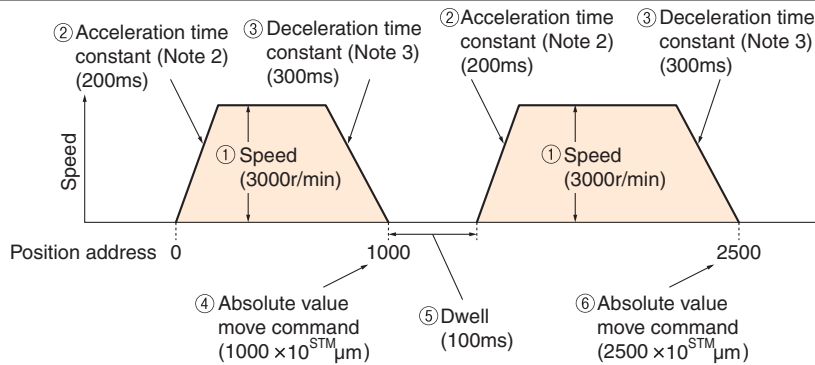

- Notes: 1. The values set as steps ①, ②, and ③ are valid as long as they are not set again.
 2. The setting value is the time elapsing from the stop of the servo motor to the rated speed.
 3. The setting value is the time elapsing from the rated speed to the stop of the servo motor.

Example 2

When repeating the steps between [FOR (setting value)] and [NEXT] commands for the number of times set:

Program	Description
SPN (3000)	Servo motor speed 3000 (r/min)
STC (20)	Acceleration and deceleration time constants 20 (ms)
MOV (1000)	Absolute value move command 1000 ($\times 10^{\text{STM}} \mu\text{m}$)
TIM(100)	Dwell 100 (ms)
FOR (3)	Step repeat command start 3 (times) ①
MOVI (100)	Incremental value move command 100 ($\times 10^{\text{STM}} \mu\text{m}$) ②
TIM (100)	Dwell 100 (ms) ③
NEXT	Step repeat command end
STOP	Program stop

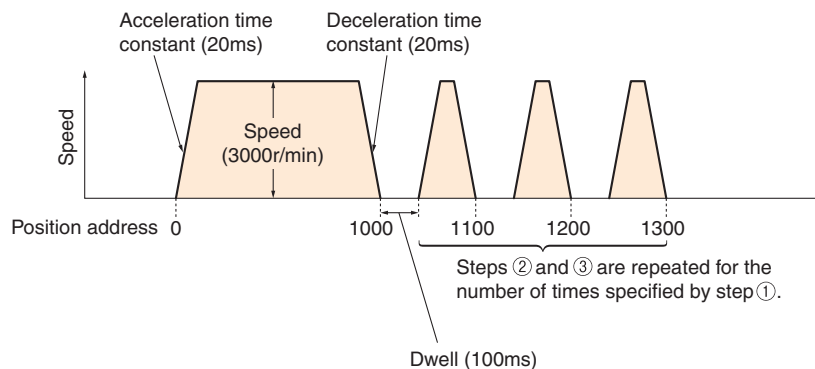

Positioning function: Program method

● Command and Operation Mode

		Item	Description
Command method	Program	Command interface	DIO (Note 1)
		Operating specification	Program language (programmed by MR Configurator (Setup software)) Program capacity: 120 steps (8 programs)
		Input positioning command	Set by the program language. One-point feed length setting range: $\pm 1\mu\text{m}$ to $\pm 999999 \times 10^{\text{STM}} \mu\text{m}$. (Note 2)
		System	Signed absolute value command system, incremental value command system
Operation mode	Automatic operation mode	Program method	Depends on the setting of the program language
	Manual operation mode	JOG	Inches upon input based on speed commands set by a parameter.
		Manual pulse generator	Manual feed by manual pulse generator. Command pulse multiplication: $\times 1$, $\times 10$ or $\times 100$ is selectable by the parameter.
	Home position return mode	Dog type	Returns to home position upon Z-phase pulse count after passing through proximity dog. Direction for return to home position selectable. Home position shift amount and home position address settable. Automatic retreat on dog back to home position and automatic stroke retreat function.
		Count type	Returns to home position upon Z-phase pulse count after touching proximity dog. Direction for return to home position selectable. Home position shift amount and home position address settable. Automatic retreat on dog back to home position and automatic stroke retreat function.
		Data set type	Returns to home position without dog. Sets any position as home position using manual operation, etc. Home position address settable.
		Stopper type	Returns to home position upon hitting end of stroke. Direction for return to home position selectable. Home position address settable.
		Ignore home (Servo-on position as home position)	Uses position where the servo on (SON) signal turns ON as home position. Home position address settable.
		Dog type rear end reference	Returns to home position with respect to the rear end of a proximity dog. Direction for return to home position selectable. Home position shift amount and home position address settable. Automatic retreat on dog back to home position and automatic stroke retreat function.
		Count type front end reference	Returns to home position with respect to the front end of a proximity dog. Direction for return to home position selectable. Home position shift amount and home position address settable. Automatic retreat on dog back to home position and automatic stroke retreat function.
Dog cradle type	Returns to home position upon the first Z-phase pulse with respect to the front end of a proximity dog. Direction for return to home position selectable. Home position shift amount and home position address settable. Automatic retreat on dog back to home position and automatic stroke retreat function.		

Notes: 1. The command interface will be compatible with pulse train command by using manual pulse generator (MR-HDP01).
2. STM is the ratio for the data. It can be changed by parameter.

● Connection example

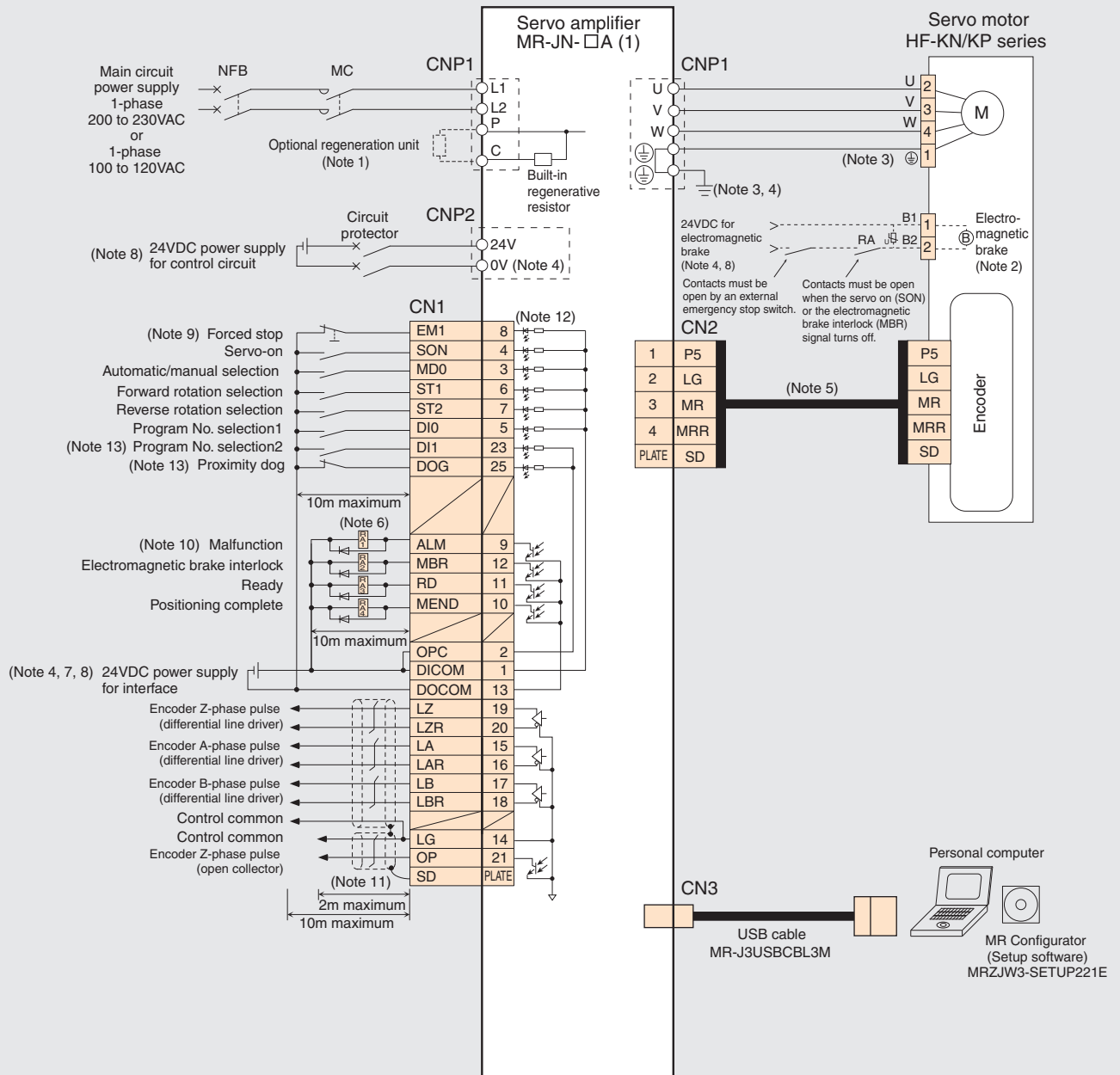

HF-KN Series Servo Motor Specifications

Servo motor series		HF-KN series (Low inertia, small capacity)			
Servo motor model		HF-KN053(B)	HF-KN13(B)	HF-KN23(B)	HF-KN43(B)
Compatible Servo amplifier model		MR-JN-10A (1)		MR-JN-20A (1)	MR-JN-40A
Power supply capacity (kVA) (Note 1)		0.3	0.3	0.5	0.9
Continuous running duty	Rated output (W)	50	100	200	400
	Rated torque (Note 8) (N·m [oz·in])	0.16 (22.7)	0.32 (45.3)	0.64 (90.6)	1.3 (184)
Maximum torque (N·m [oz·in])		0.48 (68.0)	0.95 (135)	1.9 (269)	3.8 (538)
Rated speed (r/min)		3000			
Maximum speed (r/min)		4500			
Permissible instantaneous speed (r/min)		5175			
Power rate at continuous rated torque (kW/s)		4.87	11.5	16.9	38.6
Rated current (A)		0.9	0.8	1.4	2.7
Maximum current (A)		2.7	2.4	4.2	8.1
Regenerative braking frequency (times/min) (Note 2)		(Note 3)	(Note 3)	470	261
Moment of inertia J ($\times 10^{-4}$ kg·m ²) [J (oz·in ²)]	Standard	0.052 (0.284)	0.088 (0.481)	0.24 (1.31)	0.42 (2.30)
	With electromagnetic brake	0.054 (0.295)	0.090 (0.492)	0.31 (1.69)	0.50 (2.73)
Recommended load to motor inertia moment ratio (Note 4)		15 times maximum		24 times maximum	22 times maximum
Speed/position detector		Incremental 17-bit encoder (resolution: 131072 p/rev)			
Attachments		—			
Insulation class		Class B			
Structure		Totally enclosed non ventilated (IP rating: IP65) (Note 5)			
Environment (Note 7)	Ambient temperature	0 to 40°C (32 to 104°F) (non freezing), storage: -15 to 70°C (5 to 158°F) (non freezing)			
	Ambient humidity	80% RH maximum (non condensing), storage: 90% RH maximum (non condensing)			
	Atmosphere	Indoors (no direct sunlight); no corrosive gas, inflammable gas, oil mist or dust			
	Elevation	1000m or less above sea level			
	Vibration (Note 6)	X: 49m/s ² Y: 49m/s ²			
Mass (kg [lb])	Standard	0.4 (0.89)	0.5 (1.1)	1.0 (2.2)	1.4 (3.1)
	With electromagnetic brake	0.6 (1.3)	0.7 (1.5)	1.4 (3.1)	1.8 (4.0)

Notes: 1. The power supply capacity varies depending on the power supply's impedance.

2. The regenerative braking frequency shows the permissible frequency when the motor, without a load and an optional regeneration unit, decelerates from the rated speed to a stop. When a load is connected; however, the value will be the table value/(m+1), where m=load inertia moment/motor inertia moment. When the operating speed exceeds the rated speed, the regenerative braking frequency is inversely proportional to the square of (operating speed/rated speed). If the operating speed changes frequently or when the regeneration is constant (as with vertical feeds), find the regenerative heating value (W) in operation. Provisions must be made to keep this heating value below the tolerable regenerative power (W).

Optimal regenerative resistor varies for each system. Select the most suitable regenerative resistor by using the capacity selection software. Refer to the section "Options ● Optional regeneration unit" in this catalog for details on the tolerable regenerative power (W).

3. When the motor decelerates to a stop from the rated speed, the regenerative frequency will not be limited if the effective torque is within the rated torque range. When the motor decelerates to a stop from the maximum speed, the regenerative frequency will not be limited if the effective torque is within the rated torque range and if the load to motor inertia moment is 8 times or less for HF-KN053(B) or 4 time or less for HF-KN13(B).

4. Contact your local sales office if the load to motor inertia moment ratio exceeds the value in the table.

5. The shaft-through portion is excluded.

6. The vibration direction is shown in the diagram to the right. The value indicates the maximum value of the component (normally the bracket in the opposite direction of the motor shaft). Fretting of the bearing occurs easily when the motor stops, so maintain vibration to approximately one-half of the allowable value.

7. In the environment where the servo motor is exposed to oil mist, oil and/or water, a standard specification servo motor may not be usable.

Contact your local sales office for more details.

8. When unbalanced torque is generated, such as in a vertical lift machine, it is recommended that the unbalanced torque of the machine be kept under 70% of the motor's rated torque.



HF-KN Series Servo Motor Torque Characteristics

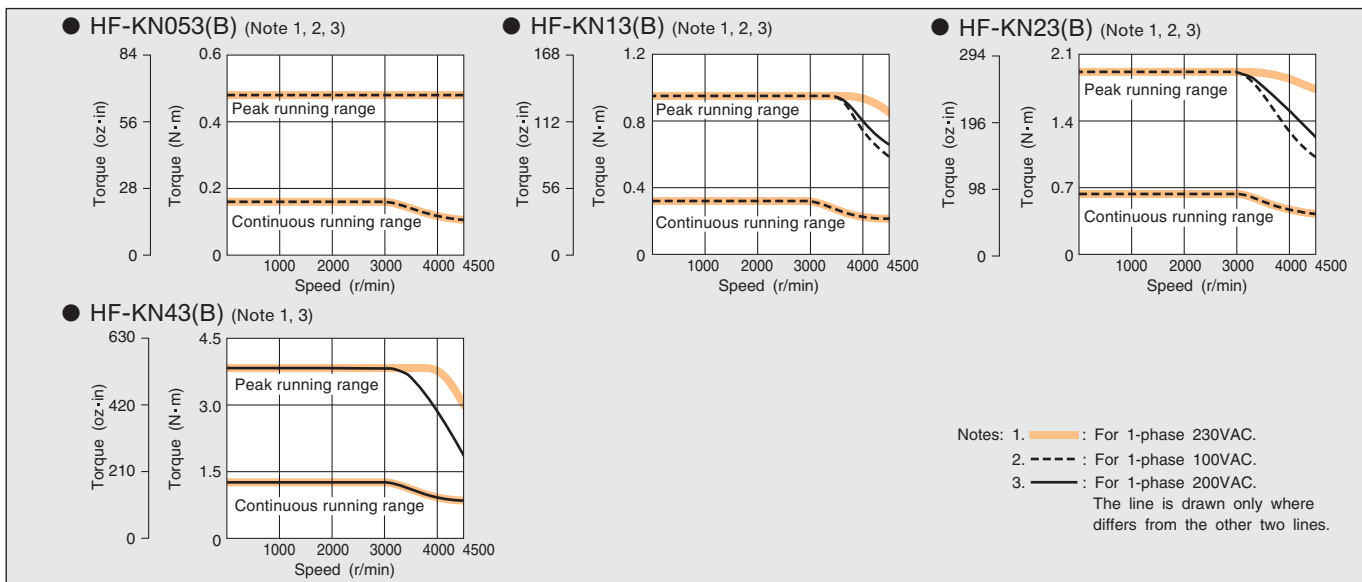

HF-KP Series Gearing Servo Motor Specifications

Servo motor series		HF-KP series (Low inertia, small capacity)			
Servo motor model		HF-KP053(B)G□	HF-KP13(B)G□	HF-KP23(B)G□	HF-KP43(B)G□
Compatible Servo amplifier model		MR-JN-10A (1)		MR-JN-20A (1)	MR-JN-40A
Power supply capacity (kVA) (Note 1)		0.3	0.3	0.5	0.9
Continuous running duty	Rated output (W)	50	100	200	400
	Rated torque (N·m [oz·in]) (Note 8, 11)	0.16 (22.7)	0.32 (45.3)	0.64 (90.6)	1.3 (184)
Maximum torque (N·m [oz·in]) (Note 8)		0.48 (68.0)	0.95 (135)	1.9 (269)	3.8 (538)
Rated speed (r/min) (Note 9)		3000			
Maximum speed (r/min) (Note 9)		4500 (Note 6)			
Permissible speed (r/min)		Refer to "Gearing Servo Motor Specifications" in this catalog.			
Power rate at continuous rated torque (kW/s) (Note 8)		4.87	11.5	16.9	38.6
Rated current (A)		0.9	0.8	1.4	2.7
Maximum current (A)		2.7	2.4	4.2	8.1
Regenerative braking frequency (times/min) (Note 2, 6)		(Note 3)	(Note 3)	474	276
Moment of inertia J (×10 ⁻⁴ kg·m ²) [J (oz·in ²)]	Standard	Refer to "HF-KP Series Gearing Servo Motor Dimensions" in this catalog.			
	With electromagnetic brake				
Permissible load to motor inertia moment ratio		Refer to "Gearing Servo Motor Specifications" in this catalog.			
Speed/position detector		Absolute/incremental 18-bit encoder (resolution 262144 p/rev) (Note 10)			
Attachments		—			
Insulation class		Class B			
Structure		Totally enclosed non ventilated (IP rating: IP44) (Note 4)			
Environment (Note 7)	Ambient temperature	0 to 40°C (32 to 104°F) (non freezing), storage: -15 to 70°C (5 to 158°F) (non freezing)			
	Ambient humidity	80% RH maximum (non condensing), storage: 90% RH maximum (non condensing)			
	Atmosphere	Indoors (no direct sunlight); no corrosive gas, inflammable gas, oil mist or dust			
	Elevation	1000m or less above sea level			
	Vibration (Note 5, 8)	X: 49m/s ² Y: 49m/s ²			
Mass (kg [lb])	Standard	Refer to "HF-KP Series Gearing Servo Motor Dimensions" in this catalog.			
	With electromagnetic brake				

- Notes: 1. The power supply capacity varies depending on the power supply's impedance.
 2. The regenerative braking frequency shows the permissible frequency when the motor, without a load and an optional regeneration unit, decelerates from the rated speed to a stop. When a load is connected, however, the value will be the table value/(m+1), where m=load inertia moment/motor inertia moment. When the operating speed exceeds the rated speed, the regenerative braking frequency is inversely proportional to the square of (operating speed/rated speed). If the operating speed changes frequently or when the regeneration is constant (as with vertical feeds), find the regenerative heating value (W) in operation. Provisions must be made to keep this heating value below the tolerable regenerative power (W).
 Optimal regenerative resistor varies for each system. Select the most suitable regenerative resistor by using the capacity selection software. Refer to the section "Options ● Optional regeneration unit" in this catalog for details on the tolerable regenerative power (W).
 3. When the motor decelerates to a stop from the rated speed, the regenerative frequency will not be limited if the effective torque is within the rated torque range. When the motor decelerates to a stop from the maximum speed, the regenerative frequency will not be limited if the effective torque is within the rated torque range and if the load to motor inertia moment is 8 times or less for HF-KP053(B)G□ or 4 time or less for HF-KP13(B)G□.
 4. The shaft-through portion is excluded.
 5. The vibration direction is shown in the diagram to the right. The value indicates the maximum value of the component (normally the bracket in the opposite direction of the motor shaft). Fretting of the bearing occurs easily when the motor stops, so maintain vibration to approximately one-half of the allowable value.
 6. The values are applicable when combining with MR-JN servo amplifier series.
 7. In the environment where the servo motor is exposed to oil mist, oil and/or water, a standard specification servo motor may not be usable. Contact your local sales office for more details.
 8. The values are applicable for the servo motor without reducer.
 9. The values are applicable at the reducer input shaft.
 10. When combined with MR-JN servo amplifier series, the detector performance is equivalent to an incremental 17-bit encoder.
 11. When unbalanced torque is generated, such as in a vertical lift machine, it is recommended that the unbalanced torque of the machine be kept under 70% of the motor's rated torque.
- 

HF-KP Series Gearing Servo Motor Torque Characteristics (Note 1)

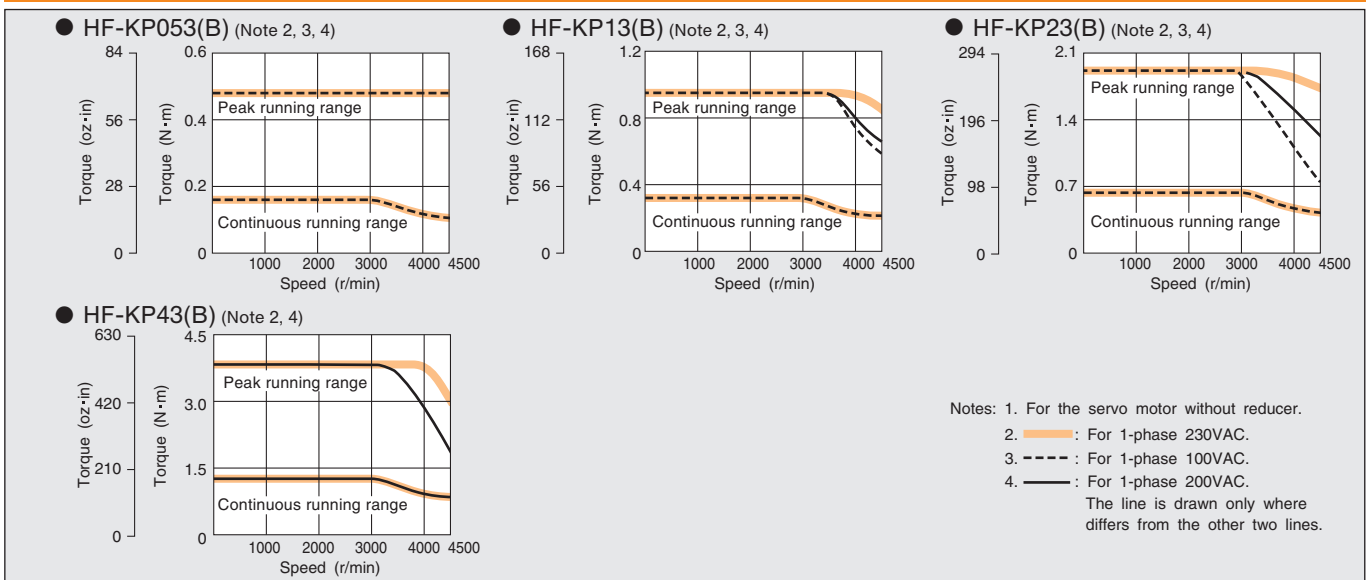

Servo amplifiers
 Servo motors
 Options
 Peripheral Equipment
 Servo Support Software
 Dimensions
 Cautions

Geared Servo Motor Specifications

● With reducer for general industrial machines (G1)

Combination list (Note 1)

Output (W)	HF-KP series (Note 2)		
	1/5	1/12	1/20
50	○(9/44)	○(49/576)	○(25/484)
100	○(9/44)	○(49/576)	○(25/484)
200	○(19/96)	○(25/288)	○(253/5000)
400	○(19/96)	○(25/288)	○(253/5000)

Notes: 1. The ○ mark in the table shows the manufacturing range. The servo motor can be mounted in any direction.
2. The values in () are the actual reduction ratio.

Specifications

Servo motor series	HF-KP series
Reducer efficiency (Note 1)	45% to 75%
Mounting method	Flange mounting
Lubrication	Grease lubrication (already packed)
Output shaft rotating direction	Same as the servo motor output shaft direction
With electromagnetic brake	Available
Backlash	60 minutes or less at reducer output shaft
Permissible load to motor inertia moment ratio (Note 2) (when converting into the servo motor shaft)	For 50W or 100W: Maximum of 5 times the servo motor's inertia moment For 200W or 400W: Maximum of 7 times the servo motor's inertia moment
Permissible speed (at reducer input shaft)	4500r/min

Notes: 1. The reducer efficiency varies depending on the reduction ratio. It also changes depending on the conditions of use, such as output torque, speed, temperature. The values in the table represent typical values at the rated torque and speed and at the normal temperature. They are not guaranteed values.
2. Contact your local sales office if the load to motor inertia moment ratio exceeds the value in the table.

● With flange output type reducer for precision application, flange mounting (G5) With shaft output type reducer for precision application, flange mounting (G7)

Combination list (Note 1)

Output (W)	HF-KP series				
	1/5	1/11	1/21	1/33	1/45
50	○	○	○	○	○
100	○	○	○	○	○
200	○	○	○	○	○
400	○	○	○	○	○

Notes: 1. The ○ mark in the table shows the manufacturing range. The servo motor can be mounted in any direction.

Specifications

Servo motor series	HF-KP series
Reducer efficiency (Note 1)	58% to 87% (Note 2)
Mounting method	Flange mounting
Lubrication	Grease lubrication (already packed)
Output shaft rotating direction	Same as the servo motor output shaft direction
With electromagnetic brake	Available
Backlash	3 minutes or less at reducer output shaft
Permissible load to motor inertia moment ratio (Note 3) (when converting into the servo motor shaft)	For 50W or 100W: Maximum of 10 times the servo motor's inertia moment For 200W or 400W: Maximum of 14 times the servo motor's inertia moment
Permissible speed (at reducer input shaft)	4500r/min (Note 4)

Notes: 1. The reducer efficiency varies depending on the reduction ratio. It also changes depending on the conditions of use, such as output torque, speed, temperature. The values in the table represent typical values at the rated torque and speed and at the normal temperature. They are not guaranteed values.
2. The reducer efficiency of HF-KP053 is 22% to 41%.
3. Contact your local sales office if the load to motor inertia moment ratio exceeds the value in the table.
4. The value is applicable when combining with MR-JN servo amplifier series.

Electromagnetic Brake Specifications (Note 1)

Servo motor model	HF-KN053B	HF-KN13B	HF-KN23B	HF-KN43B	HF-KP053BG□	HF-KP13BG□	HF-KP23BG□	HF-KP43BG□	
Type	Spring-action safety brake				Spring-action safety brake				
Rated voltage	24VDC ⁰ / ₋₁₀ %				24VDC ⁰ / ₋₁₀ %				
Brake static friction torque	(N·m)	0.32	0.32	1.3	1.3	0.32	0.32	1.3	1.3
	(oz·in)	45.3	45.3	184	184	45.3	45.3	184	184
Power consumption (W) at 20°C (68°F)	6.3	6.3	7.9	7.9	6.3	6.3	7.9	7.9	
Permissible braking work	(J)/time	5.6	5.6	22	22	5.6	5.6	22	22
	(J)/hour	56	56	220	220	56	56	220	220
Brake life (Note 2)	Number of times	20000	20000	20000	20000	20000	20000	20000	20000
	Work per breaking	5.6	5.6	22	22	5.6	5.6	22	22

Notes: 1. The electromagnetic brake is for holding. It cannot be used for deceleration applications.
2. The brake gap cannot be adjusted. The brake life shows time until the readjustment is needed.

Special Shaft End Specifications

Motors with the following specifications are also available.

HF-KN series

● D-cut shaft (Note 1) (50W, 100W)

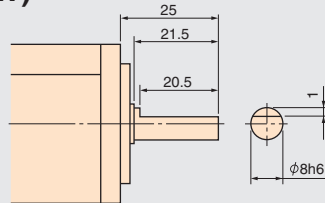

(Unit: mm)

● Keyway shaft with key (Note 1) (200W, 400W)

Servo motor model	Capacity (W)	Variable dimensions								
		T	S	R	Q	W	QK	QL	U	Y
HF-KN□K	200, 400	5	14h6	30	27	5	20	3	3	M4 screw Depth: 15mm

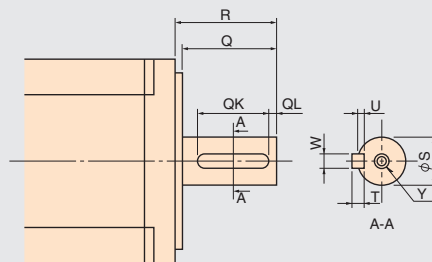

(Unit: mm)

HF-KP series

The standard shaft for HF-KP □ G1 (with reducer for general industrial machines) is straight. The shaft with key is available as a special specification. Contact your local sales office for more details.

The standard shaft for HF-KP □ G7 (with shaft output type reducer for precision application, flange mounting) is straight. However, the shaft with key (HF-KP □ G7K) is also available. Refer to the followings for the shaft-end shape.

● Keyway shaft with key (Note 1, 2, 3)

Servo motor model	Reduction ratio	Variable dimensions						
		S	Q	W	QK	U	T	Y
HF-KP053G7K	1/5	16	28	5	25	3	5	M4 screw Depth: 8mm
	1/11							
	1/21							
	1/33							
	1/45							
HF-KP13G7K	1/5	25	42	8	36	4	7	M6 screw Depth: 12mm
	1/11							
	1/21							
	1/33							
	1/45							
HF-KP23G7K	1/5	16	28	5	25	3	5	M4 screw Depth: 8mm
	1/11							
	1/21							
	1/33							
	1/45							
HF-KP43G7K	1/5	16	28	5	25	3	5	M4 screw Depth: 8mm
	1/11							
	1/21							
	1/33							
	1/45							

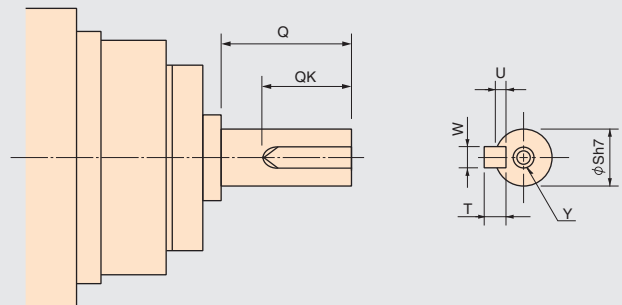

(Unit: mm)

Notes: 1. The servo motor with the keyway shaft or the D-cut shaft cannot be used in frequent start/stop applications.

2. A key (single-point key) is supplied.

3. The dimensions not mentioned in the drawings are the same as those of the straight shaft of HF-KP□G7. Refer to "HF-KP Series Geared Servo Motor Dimensions ● HF-KP□(B) G7" in this catalog.

Options

● Cables and connectors

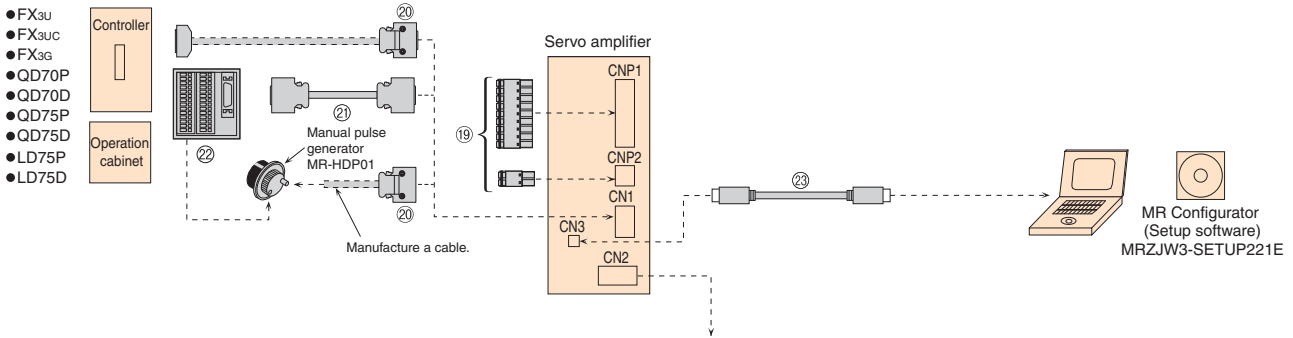

For encoder cable length 10m or shorter

- For leading the cables out in a direction of the motor shaft (Note 4)

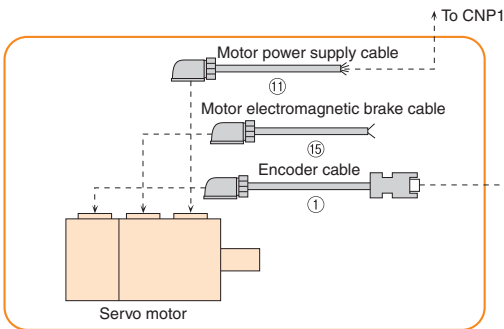

- For leading the cables out in an opposite direction of the motor shaft (Note 4)

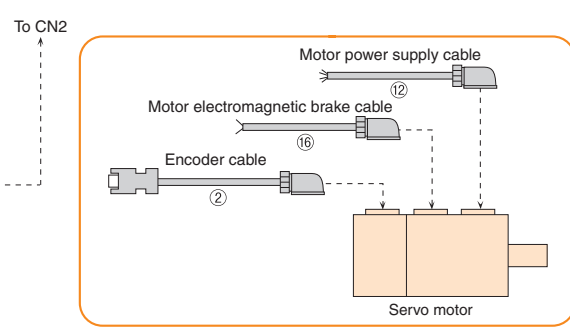

For encoder cable length over 10m

- For leading the cables out in a direction of the motor shaft (Note 4)

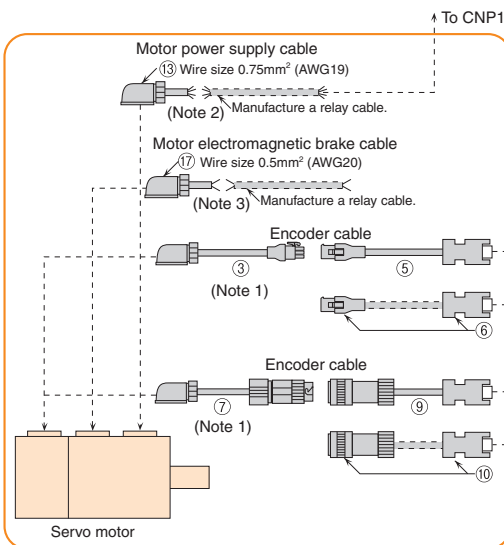



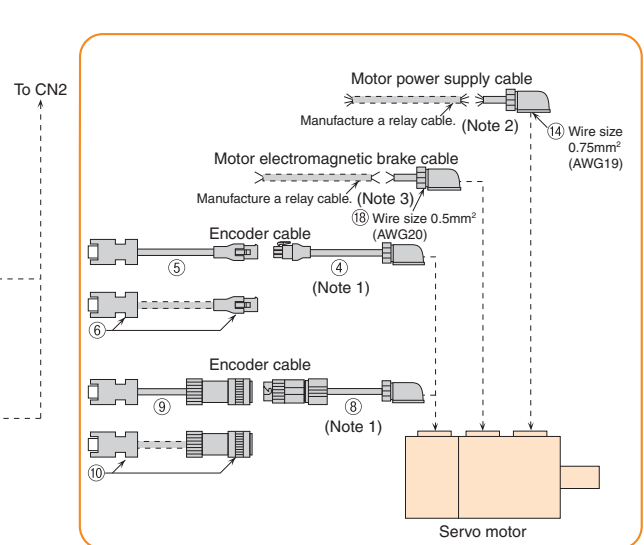



- For leading the cables out in an opposite direction of the motor shaft (Note 4)

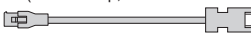

- Notes: 1. This cable does not have a long bending life, so always fix the cable before using.
 2. If the length exceeds 10m, relay a cable using MR-PWS2CBL03M-A1-L/-A2-L cable. This cable does not have a long bending life, so always fix the cable before using. Refer to "MR-JN-□A INSTRUCTION MANUAL" for details on manufacturing the relay cable.
 3. If the length exceeds 10m, relay a cable using MR-BKS2CBL03M-A1-L/-A2-L cable. This cable does not have a long bending life, so always fix the cable before using. Refer to "MR-JN-□A INSTRUCTION MANUAL" for details on manufacturing the relay cable.
 4. Cables for leading two different directions may be used for one servo motor.

● Cables and connectors

		Item	Model	IP rating (Note 2)	Description
For encoder	① 10m or shorter (Direct connection type)	Encoder cable Lead out in direction of motor shaft	MR-J3ENCBL□M-A1-H □=cable length: 2, 5, 10m (Note 1, 4)	IP65	 Encoder connector (Tyco Electronics) 1674320-1 Amplifier connector 36210-0100PL (receptacle, 3M) 36310-3200-008 (shell kit, 3M) or 54599-1019 (connector set, Molex)
			MR-J3ENCBL□M-A1-L □=cable length: 2, 5, 10m (Note 1)	IP65	
		Encoder cable Lead out in opposite direction of motor shaft	MR-J3ENCBL□M-A2-H □=cable length: 2, 5, 10m (Note 1, 4)	IP65	
			MR-J3ENCBL□M-A2-L □=cable length: 2, 5, 10m (Note 1)	IP65	
	③	Motor-side encoder cable Lead out in direction of motor shaft	MR-J3JCBLO3M-A1-L Cable length: 0.3m (Note 1)	IP20	 Encoder connector (Tyco Electronics) 1674320-1 Junction connector (Tyco Electronics) 1473226-1 (with ring) (contact) 1-172169-9 (housing) 316454-1 (cable clamp)
			MR-J3JCBLO3M-A2-L Cable length: 0.3m (Note 1)	IP20	
	④	Motor-side encoder cable Lead out in opposite direction of motor shaft	MR-J3JCBLO3M-A1-L Cable length: 0.3m (Note 1)	IP20	Use this in combination of ③ or ④.
			MR-J3JCBLO3M-A2-L Cable length: 0.3m (Note 1)	IP20	
	⑤ Exceeding 10m (Relay type)	Amplifier-side encoder cable	MR-EKCBL□M-H □=cable length: 20, 30,40, 50m (Note 1, 4)	IP20	 Junction connector (Tyco Electronics) 1-172161-9 (housing) 170359-1 (connector pin) MTI-0002 (cable clamp, TOA ELECTRIC INDUSTRIAL) Amplifier connector 36210-0100PL (receptacle, 3M) 36310-3200-008 (shell kit, 3M) or 54599-1019 (connector set, Molex)
			MR-EKCBL□M-L □=cable length: 20, 30m (Note 1)	IP20	
⑥	Junction connector set	MR-ECNM	IP20	 Junction connector (Tyco Electronics) 1-172161-9 (housing) 170359-1 (connector pin) MTI-0002 (cable clamp, TOA ELECTRIC INDUSTRIAL) Amplifier connector 36210-0100PL (receptacle, 3M) 36310-3200-008 (shell kit, 3M) or 54599-1019 (connector set, Molex) <Applicable cable example> Wire size: 0.3mm ² (AWG22) Completed cable outer diameter: φ8.2mm Crimping tool (91529-1) is required.	
		Use these in combination of ③ or ④.			
⑦	Motor-side encoder cable Lead out in direction of motor shaft	MR-J3JSCBL03M-A1-L Cable length: 0.3m (Note 1)	IP65 (Note 3)	 Encoder connector (Tyco Electronics) 1674320-1 Junction connector (DDK) CM10-CR10P-M (cable receptacle)	
		MR-J3JSCBL03M-A2-L Cable length: 0.3m (Note 1)	IP65 (Note 3)		
⑧	Motor-side encoder cable Lead out in opposite direction of motor shaft	MR-J3JSCBL03M-A1-L Cable length: 0.3m (Note 1)	IP65 (Note 3)	Use this in combination of ⑦ or ⑧.	
		MR-J3JSCBL03M-A2-L Cable length: 0.3m (Note 1)	IP65 (Note 3)		
⑨ Exceeding 10m (Relay type)	Amplifier-side encoder cable	MR-J3ENSCBL□M-H □=cable length: 2, 5, 10, 20, 30, 40, 50m (Note 1, 4)	IP67	 Amplifier connector 36210-0100PL (receptacle, 3M) 36310-3200-008 (shell kit, 3M) or 54599-1019 (connector set, Molex) Junction connector (DDK) <For 10m or shorter cable> CM10-SP10S-M (D6) (straight plug) CM10-#22SC (C1) (D8) -100 (socket contact) <For 10m or longer cable> CM10-SP10S-M (D6) (straight plug) CM10-#22SC (C2) (D8) -100 (socket contact)	
		MR-J3ENSCBL□M-L □=cable length: 2, 5, 10, 20, 30m (Note 1)	IP67		
⑩	Junction connector set	MR-J3SCNS	IP67	 Amplifier connector 36210-0100PL (receptacle, 3M) 36310-3200-008 (shell kit, 3M) or 54599-1019 (connector set, Molex) Junction connector (DDK) CM10-SP10S-M (D6) (straight plug) CM10-#22SC (S1) (D8) -100 (socket contact) <Applicable cable example> Wire size: 0.5mm ² (AWG20) or smaller Completed cable outer diameter: φ6.0 to 9.0mm	
Use these in combination of ⑦ or ⑧.					

Notes: 1. -H and -L indicate a bending life. -H indicates a long bending life, and -L indicates a standard bending life.

2. The IP rating indicated is for the connector's protection against ingress of dust and water when coupled to a servo amplifier/servo motor.









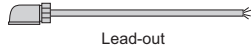

If the IP rating of the servo amplifier/servo motor differs from that of these connectors, overall IP rating depends on the lowest of all.

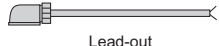
3. The encoder cable is rated IP65 while the junction connector is rated IP67.

4. For the ultra-long bending life cables and/or for unlisted lengths (available in the ultra-long bending life cables), contact Mitsubishi Electric System & Service Co., Ltd. FA PRODUCT DIVISION by email: oss-ip@melsc.jp

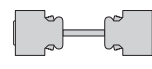
Options

● Cables and connectors

Item			Model	IP rating (Note 2)	Description	
For servo motor power supply	⑪	10m or shorter (Direct connection type)	Power supply cable Lead out in direction of motor shaft	MR-PWS1CBL□M-A1-H □=cable length: 2, 5, 10m (Note 1, 3)	IP65	Motor power supply connector (Japan Aviation Electronics Industry) JN4FT04SJ1-R (plug) ST-TMH-S-C1B-100-(A534G) (socket contact)
			Power supply cable Lead out in opposite direction of motor shaft	MR-PWS1CBL□M-A1-L □=cable length: 2, 5, 10m (Note 1)	IP65	
	⑫	Power supply cable Lead out in opposite direction of motor shaft	MR-PWS1CBL□M-A2-H □=cable length: 2, 5, 10m (Note 1, 3)	IP65	 Lead-out	
			MR-PWS1CBL□M-A2-L □=cable length: 2, 5, 10m (Note 1)	IP65		
⑬	Exceeding 10m (Relay type)	Power supply cable Lead out in direction of motor shaft	MR-PWS2CBL03M-A1-L Cable length: 0.3m (Note 1)	IP55	Motor power supply connector (Japan Aviation Electronics Industry) JN4FT04SJ2-R (plug) ST-TMH-S-C1B-100-(A534G) (socket contact)	
		Power supply cable Lead out in opposite direction of motor shaft	MR-PWS2CBL03M-A2-L Cable length: 0.3m (Note 1)	IP55	 Lead-out	
For servo motor electromagnetic brake	⑮	10m or shorter (Direct connection type)	Brake cable Lead out in direction of motor shaft	MR-BKS1CBL□M-A1-H □=cable length: 2, 5, 10m (Note 1, 3)	IP65	Motor brake connector (Japan Aviation Electronics Industry) JN4FT02SJ1-R (plug) ST-TMH-S-C1B-100-(A534G) (socket contact)
			Brake cable Lead out in opposite direction of motor shaft	MR-BKS1CBL□M-A1-L □=cable length: 2, 5, 10m (Note 1)	IP65	
	⑯	Brake cable Lead out in opposite direction of motor shaft	MR-BKS1CBL□M-A2-H □=cable length: 2, 5, 10m (Note 1, 3)	IP65	 Lead-out	
			MR-BKS1CBL□M-A2-L □=cable length: 2, 5, 10m (Note 1)	IP65		
⑰	Exceeding 10m (Relay type)	Brake cable Lead out in direction of motor shaft	MR-BKS2CBL03M-A1-L Cable length: 0.3m (Note 1)	IP55	Motor brake connector (Japan Aviation Electronics Industry) JN4FT02SJ2-R (plug) ST-TMH-S-C1B-100-(A534G) (socket contact)	
		Brake cable Lead out in opposite direction of motor shaft	MR-BKS2CBL03M-A2-L Cable length: 0.3m (Note 1)	IP55	 Lead-out	
For CNP1 and CNP2	⑲	Servo amplifier power supply connector set	(Standard accessory: Insertion type)	—	CNP1 connector	CNP2 connector
					 FKC 2,5/ 9-ST-5,08 (connector) (PHOENIX or an equivalent product)	 FKCT 2,5/ 2-ST-5,08 (connector) (PHOENIX or an equivalent product)
For CN1	⑳	Junction terminal block cable	MR-TBNATBL□M □=cable length: 0.5, 1m	—	Amplifier connector (3M or an equivalent product) 10126-3000PE (connector) 10326-52F0-008 (shell kit)	 Amplifier connector (3M or an equivalent product) 10126-6000EL (connector) 10326-3210-000 (shell kit)
					 Amplifier connector (3M or an equivalent product) 10126-6000EL (connector) 10326-3210-000 (shell kit)	 Amplifier connector (3M or an equivalent product) 10126-6000EL (connector) 10326-3210-000 (shell kit)
					 Amplifier connector (3M or an equivalent product) 10126-6000EL (connector) 10326-3210-000 (shell kit)	 Amplifier connector (3M or an equivalent product) 10126-6000EL (connector) 10326-3210-000 (shell kit)
For CN3	⑳	Personal computer communication cable USB cable	MR-J3USBCBL3M Cable length: 3m	—	Amplifier connector mini-B connector (5 pins)	Personal computer connector A connector

Notes: 1. -H and -L indicate a bending life. -H indicates a long bending life, and -L indicates a standard bending life.

2. The IP rating indicated is for the connector's protection against ingress of dust and water when coupled to a servo amplifier/servo motor.

If the IP rating of the servo amplifier/servo motor differs from that of these connectors, overall IP rating depends on the lowest of all.



3. For the ultra-long bending life cables and/or for unlisted lengths (available in the ultra-long bending life cables), contact Mitsubishi Electric System & Service Co., Ltd. FA PRODUCT DIVISION by email: oss-ip@melsc.jp

Ordering Information for Customers

To order the following products, contact the relevant manufacturers directly.

When manufacturing a cable with the following connectors, refer to the relevant manufacturers' instruction manuals for wiring and assembling procedures.

● Encoder connectors

Item	Model	IP rating (Note 2)	Description	Applicable cable example
Servo motor encoder connector	1674320-1	IP65	 Manufacturer: Tyco Electronics Corporation	Wire size: 0.14mm ² (AWG26) to 0.3mm ² (AWG22) Completed cable outer diameter: $\phi 7.1 \pm 0.3$ mm Crimping tool: 1596970-1 (for ground clip) and 1596847-1 (for receptacle contact) are required.
Servo amplifier CN2 connector (Note 1)	54599-1019 (connector set) (gray)	—	 Manufacturer: Molex	Wire example: Fluoric resin wire (Vinyl jacket cable ETFE · SVP 70/0.08 (AWG#22)-3P-KB-16824 BANDO DENSEN Co., LTD. or an equivalent product)
	54599-1016 (connector set) (black)			

● Motor power supply connector

Item	Model	IP rating (Note 2)	Description	Applicable cable example
Motor power supply connector	JN4FT04SJ1-R (plug) ST-TMH-S-C1B-100-(A534G) (socket contact)	IP65	 Manufacturer: Japan Aviation Electronics Industry, Ltd.	Wire size: 0.75mm ² (AWG19) Completed cable outer diameter: $\phi 6.2 \pm 0.3$ mm Crimping tool (CT160-3-TMH5B) is required. Wire example: Fluoric resin wire (Vinyl jacket cable RMFES-A (CL3X) AWG19 4 cores DYDEN CORPORATION or an equivalent product)

● Motor brake connector

Item	Model	IP rating (Note 2)	Description	Applicable cable example
Motor brake connector	JN4FT02SJ1-R (plug) ST-TMH-S-C1B-100-(A534G) (socket contact)	IP65	 Manufacturer: Japan Aviation Electronics Industry, Ltd.	Wire size: 0.5mm ² (AWG20) Completed cable outer diameter: $\phi 4.5 \pm 0.3$ mm Crimping tool (CT160-3-TMH5B) is required. Wire example: Fluoric resin wire (Vinyl jacket cable RMFES-A (CL3X) AWG20 2 cores DYDEN CORPORATION or an equivalent product)

Notes: 1. 3M also manufactures a connector compatible with the servo amplifier's CN2 connector.

Model: 36210-0100PL (receptacle), 36310-3200-008 (shell kit).

2. The IP rating indicated is for the connector's protection against ingress of dust and water when coupled to a servo amplifier/servo motor.

If the IP rating of the servo amplifier/servo motor differs from that of these connectors, overall IP rating depends on the lowest of all.

Peripheral Equipment

● Electrical wires, circuit breakers, magnetic contactors (example of selection)

The following are examples of wire sizes when 600V polyvinyl chloride insulated wires (IV wires) with a length of 30m are used. Smaller size of wires may be applied by using 600V grade heat-resistant polyvinyl chloride insulated wires (HIV wires).

Refer to "MR-JN-□A INSTRUCTION MANUAL" when using HIV wires.

Servo amplifier	Circuit breaker	Magnetic contactor (Note 4)	Electrical wire size (mm ²)				
			L1, L2, ⊕(Note 1)	24V, 0V	U, V, W, ⊕	P, C (Note 1)	B1, B2
MR-JN-10A	30A frame 5A	S-N10	2 (AWG14)	1.25 (AWG16)	1.25 (AWG16) (Note 2)	2 (AWG14)	1.25 (AWG16) (Note 3)
MR-JN-20A MR-JN-10A1	30A frame 10A						
MR-JN-40A MR-JN-20A1	30A frame 15A						

- Notes: 1. Connect a reactor or an optional regeneration unit using the 5m or shorter length electrical wire.
 2. Use a fluoroc resin wire (0.75mm² (AWG19)) when connecting to motor power supply connector. Refer to "MR-JN-□A INSTRUCTION MANUAL" for details on wiring cables.
 3. Use a fluoroc resin wire (0.5mm² (AWG20)) when connecting to the motor electromagnetic brake connector. Refer to "MR-JN-□A INSTRUCTION MANUAL" for details on wiring cables.
 4. Be sure to use a magnetic contactor (MC) with an operation delay time of 80ms or less. The operation delay time is the time interval between current being applied to the coil until closure of contacts.

● Radio noise filter (FR-BIF)

This filter effectively controls noise emitted from the power supply side of the servo amplifier, and is especially effective for radio frequency bands 10MHz or lower. The FR-BIF is designed for the input only.

External dimensions (Unit: mm)	Connections
	<p>This filter is not connectable to output side of the servo amplifier. Wiring should be as short as possible. Grounding is always required. Be sure to insulate the unused wire.</p>

● Line noise filter (FR-BSF01)

This filter is effective in suppressing radio noise emitted from the power supply side or output side of the servo amplifier, and also in suppressing high-frequency leakage current (zero-phase current), especially within 0.5MHz to 5MHz band.

External dimensions (Unit: mm)	Connections
	<p>Use the line noise filter for wires of the main power supply (L1, L2) of the servo amplifier, and of the motor power supply (U, V, W). Pass each of the wires through the line noise filter equal times in a same direction. For the main power supply, the effect of the filter rises as the number of passes increases, but generally four passes would be appropriate. For the motor power supply, passes must be four times or less. Do not pass the grounding (earth) wire through the filter, or the effect of the filter will drop. Wind the wires to pass through the filter as the required number of passes as shown below. If the wires are too thick to wind, use two or more filters to have the required number of passes. Place the line noise filters as close to the servo amplifier as possible for their best performance.</p>

● Data line filter

Noise can be prevented by attaching a data line filter to the pulse output cable of the pulse train output controller or the motor encoder cable.

Example

Data line filter: ESD-SR-250 (manufactured by NEC TOKIN Corporation) or ZCAT3035-1330 (manufactured by TDK Corporation)

● Surge killer

Attach surge killers to AC relays and AC valves around the servo amplifier. Attach diodes to DC relays and DC valves.

Example

Surge killer: CR-50500 (manufactured by Okaya Electric Industries Co., Ltd.)

Diode: A diode with breakdown voltage 4 or more times greater than the relay's drive voltage, and with current capacity 2 or more times greater than the relay's drive current.

Peripheral Equipment

● EMC filter

The following filter is recommended as a filter compliant with the EMC directive for the power supply of the servo amplifier.

Model	Applicable servo amplifier
HF3010A-UN	MR-JN-10A (1), MR-JN-20A (1), MR-JN-40A

External dimensions	(Unit: mm)	Connections						
<p>● HF3010A-UN (Note 1, 2)</p> <table border="1"> <thead> <tr> <th>Model</th> <th>Leakage current (mA)</th> <th>Mass kg (lb)</th> </tr> </thead> <tbody> <tr> <td>HF3010A-UN</td> <td>5</td> <td>3 (6.6)</td> </tr> </tbody> </table>		Model	Leakage current (mA)	Mass kg (lb)	HF3010A-UN	5	3 (6.6)	
Model	Leakage current (mA)	Mass kg (lb)						
HF3010A-UN	5	3 (6.6)						

Notes: 1. Manufactured by SOSHIN ELECTRIC CO., LTD.
2. A surge protector is separately required to use this EMC filter. Refer to "EMC Installation Guidelines".

● Power factor improvement AC reactor (FR-HAL)

This reactor enables users to boost the servo amplifier's power factor and reduce its power supply capacity.

Model	Applicable servo amplifier
FR-HAL-0.75K	MR-JN-10A (1) MR-JN-20A
FR-HAL-1.5K	MR-JN-40A MR-JN-20A1

External dimensions	(Unit: mm)	Connections																														
<table border="1"> <thead> <tr> <th>Model</th> <th>W</th> <th>W1</th> <th>H</th> <th>D (Note 2)</th> <th>D1</th> <th>D2</th> <th>d</th> <th>Terminal screw size</th> <th>Mass Kg (lb)</th> </tr> </thead> <tbody> <tr> <td>FR-HAL-0.75K</td> <td>104</td> <td>84</td> <td>99</td> <td>74</td> <td>56</td> <td>44</td> <td>M5</td> <td>M4</td> <td>0.8 (1.8)</td> </tr> <tr> <td>FR-HAL-1.5K</td> <td></td> <td></td> <td></td> <td>77</td> <td>61</td> <td>50</td> <td></td> <td></td> <td>1.1 (2.4)</td> </tr> </tbody> </table>		Model	W	W1	H	D (Note 2)	D1	D2	d	Terminal screw size	Mass Kg (lb)	FR-HAL-0.75K	104	84	99	74	56	44	M5	M4	0.8 (1.8)	FR-HAL-1.5K				77	61	50			1.1 (2.4)	
Model	W	W1	H	D (Note 2)	D1	D2	d	Terminal screw size	Mass Kg (lb)																							
FR-HAL-0.75K	104	84	99	74	56	44	M5	M4	0.8 (1.8)																							
FR-HAL-1.5K				77	61	50			1.1 (2.4)																							

Notes: 1. Use the front right mounting hole for grounding.
2. Maximum dimensions (The dimension varies depending on the bending degree of the input/output line.)

Servo Support Software

Capacity selection software MRZJW3-MOTSZ111E (Note 1, 2)

● Specifications

Item		Description
Types of machine component		Horizontal ball screws, vertical ball screws, rack and pinions, roll feeds, rotating tables, carts, elevators, conveyors, and other (direct inertia input) devices
Output of results	Items	Selected servo amplifier, selected servo motor, selected optional regeneration unit model, load inertia moment, load to motor inertia moment ratio, peak torque, peak torque ratio, effective torque, effective torque ratio, regenerative power, regenerative power ratio
	Printing	Prints input specifications, operation pattern, calculation process, graph of selection process feedrate (or motor speed) and torque, and selection results.
	Data storage	Entered specifications, operation patterns and selection are saved with a file name.
Inertia moment calculation function		Cylinder, core alignment column, variable speed, linear movement, suspension, conical, truncated cone

Notes: 1. MRZJW3-MOTSZ111E with software version C3 or above is compatible with MELSERVO-JN series. However, C4 or above will be compatible with MR-JN-□A1.



MR Configurator (Setup software) MRZJW3-SETUP221E (Note 1)

● Specifications

Main menu	Description
Monitors	Batch display, input/output I/F display, high speed display, graph display
Alarms	Alarm display, alarm history, display of data that generated alarm
Diagnostics	Reason for rotation failure display, system information display, tuning data display, axis name setting
Parameters	Parameter setting, tuning, display of change list, display of detailed information
Test operations	JOG operation, positioning operation, motor-less operation, forced digital output, program operation using simple language, 1-step feed
Positioning data (Note 2)	Point table, program
Project	Project creation, reading or saving, various data reading, saving or printing
Others	Help display

Notes: 1. MRZJW3-SETUP221E with software version C3 or above is compatible with MELSERVO-JN series.

2. Positioning data is available with software version C4 or above. Servo amplifier with software version B0 or above is required for the positioning function.

Compatible personal computer

When using the capacity selection software or the MR Configurator (setup software), use an IBM PC/AT compatible model running with the following operation conditions.



● Operating conditions

Components		Capacity selection software MRZJW3-MOTSZ111E (Note 4)	MR Configurator (Setup software) MRZJW3-SETUP221E
Personal computer (Note 1, 2, 3)	OS	Windows® 98, Windows® Me, Windows® 2000 Professional, Windows® XP Professional, Windows® XP Home Edition, Windows Vista® Home Basic, Windows Vista® Home Premium, Windows Vista® Business, Windows Vista® Ultimate, Windows Vista® Enterprise, Windows® 7 Starter, Windows® 7 Home Premium, Windows® 7 Professional, Windows® 7 Ultimate, Windows® 7 Enterprise	
	Processor	Pentium® 133MHz or more (Windows® 98, Windows® 2000 Professional) Pentium® 150MHz or more (Windows® Me) Pentium® 300MHz or more (Windows® XP Professional, Windows® XP Home Edition) 1GHz 32-bit (x86) (Windows Vista® Home Basic, Windows Vista® Home Premium, Windows Vista® Business, Windows Vista® Ultimate, Windows Vista® Enterprise, Windows® 7 Starter, Windows® 7 Home Premium, Windows® 7 Professional, Windows® 7 Ultimate, Windows® 7 Enterprise)	
	Memory	24MB or more (Windows® 98) 32MB or more (Windows® Me, Windows® 2000 Professional) 128MB or more (Windows® XP Professional, Windows® XP Home Edition) 512MB or more (Windows Vista® Home Basic) 1GB or more (Windows Vista® Home Premium, Windows Vista® Business, Windows Vista® Ultimate, Windows Vista® Enterprise, Windows® 7 Starter, Windows® 7 Home Premium, Windows® 7 Professional, Windows® 7 Ultimate, Windows® 7 Enterprise)	
	Free hard disk space	40MB or more	130MB or more
	Communication interface	—	Use USB port
Browser	Internet Explorer 4.0 or above		
Monitor	Resolution 800 × 600 or more, 16-bit high color	Resolution 1024 × 768 or more, 16-bit high color	
Keyboard	Compatible with above personal computers.		
Mouse	Compatible with above personal computers.		
Printer	Compatible with above personal computers.		
Communication cable	Not required	MR-J3USBCBL3M	

Notes: 1. Pentium is a registered trademark of Intel Corporation. Windows and Windows Vista are registered trademarks of Microsoft Corporation in the United States and other countries.

2. This software may not run correctly, depending on a personal computer being used.

3. These software are not compatible with 64-bit operating system.

4. MRZJW3-MOTSZ111E will be compatible with Windows® 7 soon.

MR-JN-□A Servo Amplifier Dimensions

(Unit: mm)

● MR-JN-10A, MR-JN-20A, MR-JN-10A1, MR-JN-20A1

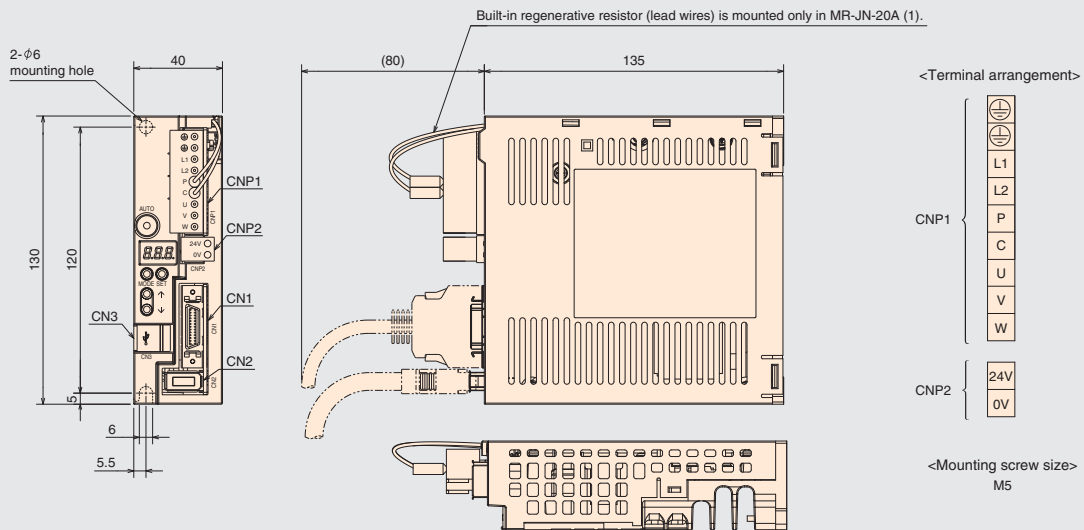

● MR-JN-40A

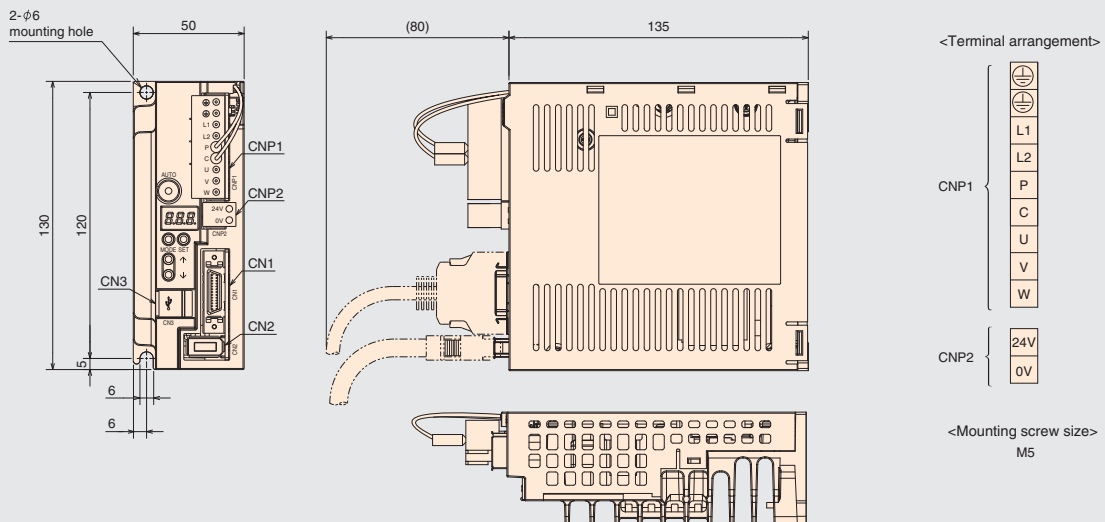

HF-KN Series Servo Motor Dimensions

(Unit: mm)

● HF-KN053(B), HF-KN13(B)

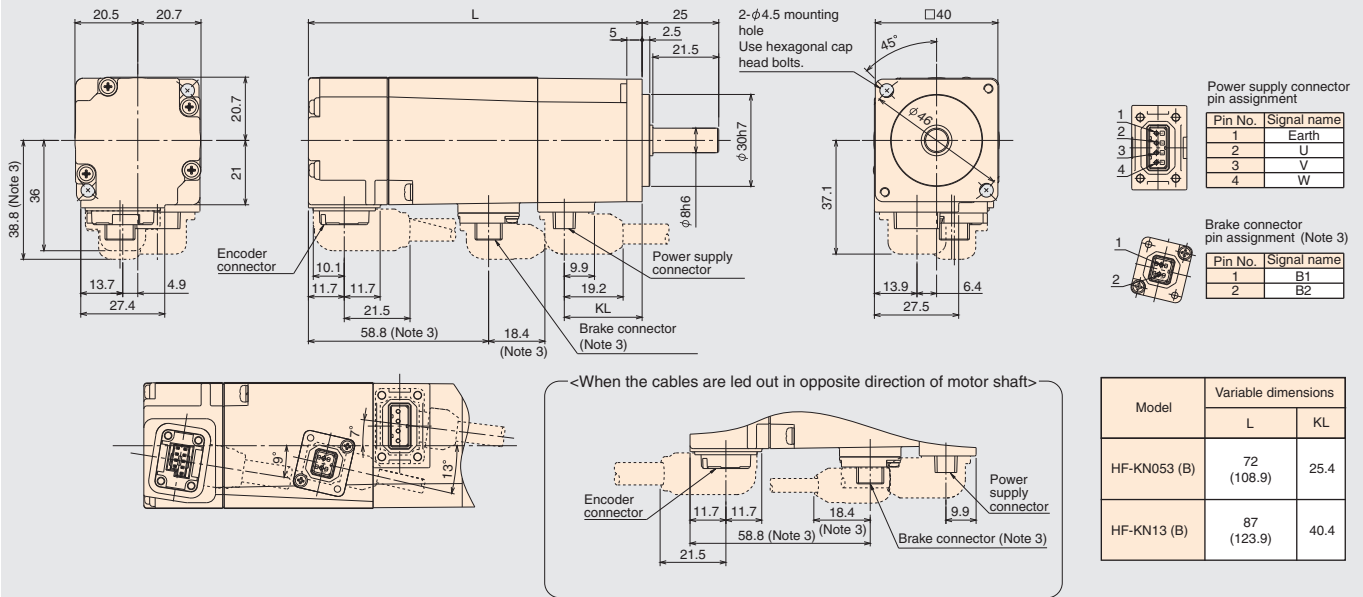

● HF-KN23(B), HF-KN43(B)

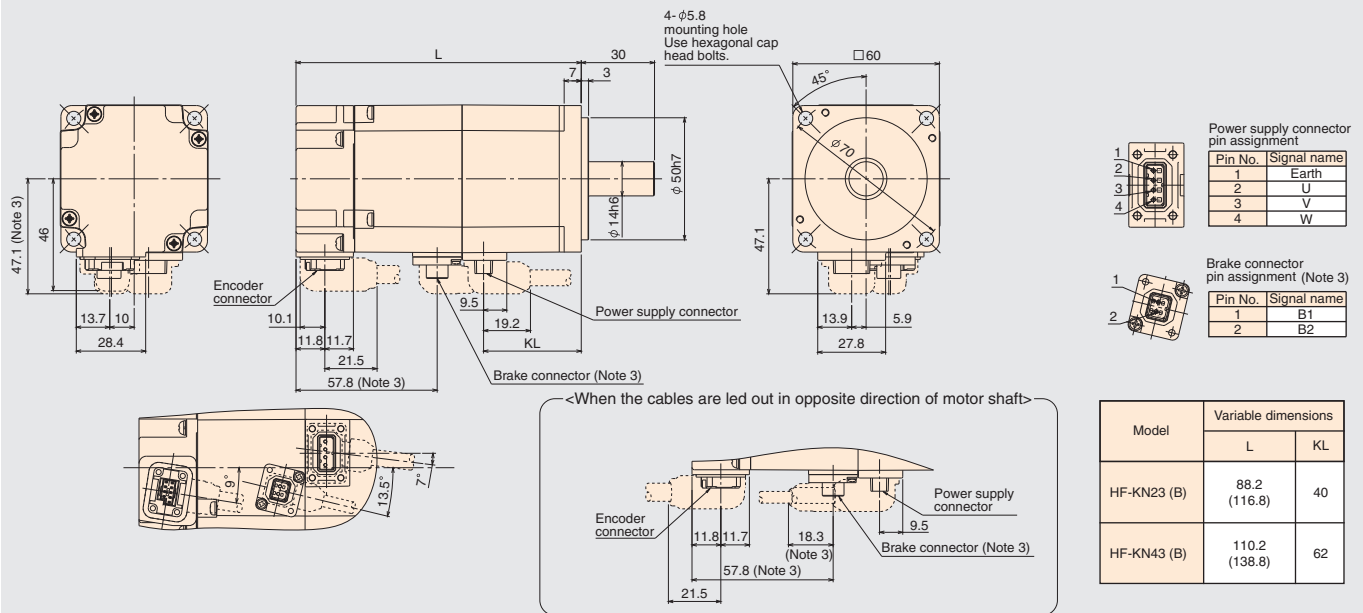

- Notes: 1. Use a friction coupling to fasten a load.
 2. Dimensions inside () are for the models with electromagnetic brake.
 3. Only for the models with electromagnetic brake. The electromagnetic brake terminals (B1, B2) do not have polarity.
 4. For dimensions where there is no tolerance listed, use general tolerance.

HF-KP Series Geared Servo Motor Dimensions

With reducer for general industrial machines

(Unit: mm)

● HF-KP□(B)G1

The following is a schematic diagram. The actual shapes or the mounting screws may differ from the following. Refer to the table below and "Servo Motor INSTRUCTION MANUAL (Vol.2)" for details.

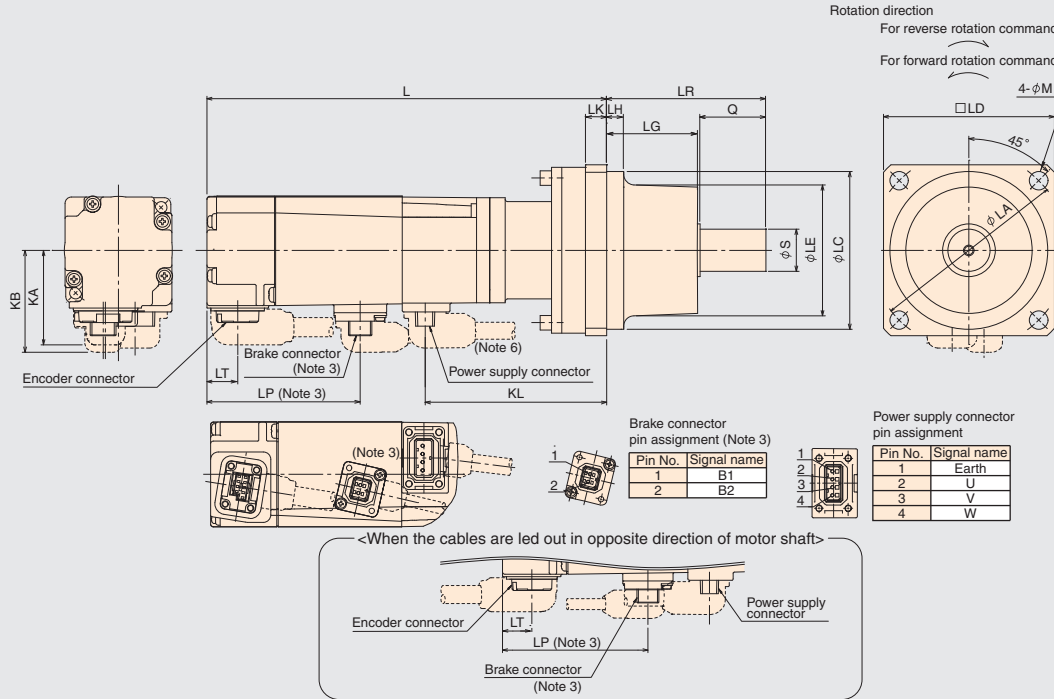

Model	Reduction ratio <actual reduction ratio>	Moment of inertia		Variable dimensions														Mass				
		J ($\times 10^{-4} \text{kg} \cdot \text{m}^2$)	J ($\text{oz} \cdot \text{in}^2$)	L	LA	LC	LD	LE	S	LH	LK	KL	LG	Q	LR	M	KA	KB	LT	LP	kg	lb
HF-KP053 (B)G1	1/5 <9/44>	0.089 (0.091)	0.487 (0.498)	110.9 (152)	75	60h7	65	50	16h6	6.5	8	69	34.5	25	60.5	7	36	37.1 (38.8)	11.7	-	1.4 (1.7)	3.1 (3.8)
	1/12 <49/576>	0.111 (0.113)	0.607 (0.618)	128.9 (170)								87									1.8 (2.1)	4.0 (4.7)
	1/20 <25/484>	0.093 (0.095)	0.508 (0.519)									85									1.6 (1.9)	3.6 (4.2)
HF-KP13 (B)G1	1/5 <9/44>	0.125 (0.127)	0.683 (0.694)	126.9 (168)	100	82h7	90	73	25h6	8	10	85	38	35	74	9	46	47.1 (47.1)	11.8	-	1.6 (1.9)	3.6 (4.2)
	1/12 <49/576>	0.147 (0.149)	0.804 (0.815)	144.9 (186)								103									2.0 (2.3)	4.4 (5.1)
	1/20 <25/484>	0.129 (0.131)	0.705 (0.716)									92.8									1.6 (1.9)	3.6 (4.2)
HF-KP23 (B)G1	1/5 <19/96>	0.400 (0.470)	2.19 (2.57)	130.1 (169.6)	115	95h7	100	86	32h6	10	10	92.8	39	50	90	9	46	47.1 (47.1)	11.8	-	3.3 (3.9)	7.3 (8.6)
	1/12 <25/288>	0.450 (0.520)	2.46 (2.84)	150.1 (189.6)								112.8									3.9 (4.5)	8.6 (10)
	1/20 <253/5000>	0.420 (0.490)	2.3 (2.68)									114.7									3.9 (4.4)	8.6 (9.7)
HF-KP43 (B)G1	1/5 <19/96>	0.570 (0.650)	3.12 (3.55)	152 (191.5)	115	95h7	100	86	32h6	10	10	114.7	39	50	90	9	46	47.1 (47.1)	11.8	-	3.9 (4.4)	8.6 (9.7)
	1/12 <25/288>	0.620 (0.700)	3.39 (3.83)	172 (211.5)								134.7									4.5 (5.0)	10 (11)
	1/20 <253/5000>	0.930 (1.01)	5.08 (5.52)	175.5 (215)								138.2									5.6 (6.1)	13 (14)

- Notes: 1. Use a friction coupling to fasten a load.
 2. Dimensions inside () are for the models with electromagnetic brake.
 3. Only for the models with electromagnetic brake. The electromagnetic brake terminals (B1, B2) do not have polarity.
 4. The moments of inertia in the table are the values that are converted into motor shaft for the motor with reducer (and with electromagnetic brake).
 5. For dimensions where there is no tolerance listed, use general tolerance. The actual dimensions may be 1mm to 3mm larger than the dimensions listed since the outer frame of the reducer is made by casting. Design a machine in order to make allowances.
 6. Lead out the power supply cable in opposite direction of the motor shaft for the following servo motors:
 • All gear ratios for HF-KP053(B)G1 and HF-KP13(B)G1

With flange output type reducer for precision application, flange mounting

(Unit: mm)

● HF-KP□(B)G5

The following is a schematic diagram. The actual shapes or the mounting screws may differ from the following. Refer to the table below and "Servo Motor INSTRUCTION MANUAL (Vol.2)" for details.

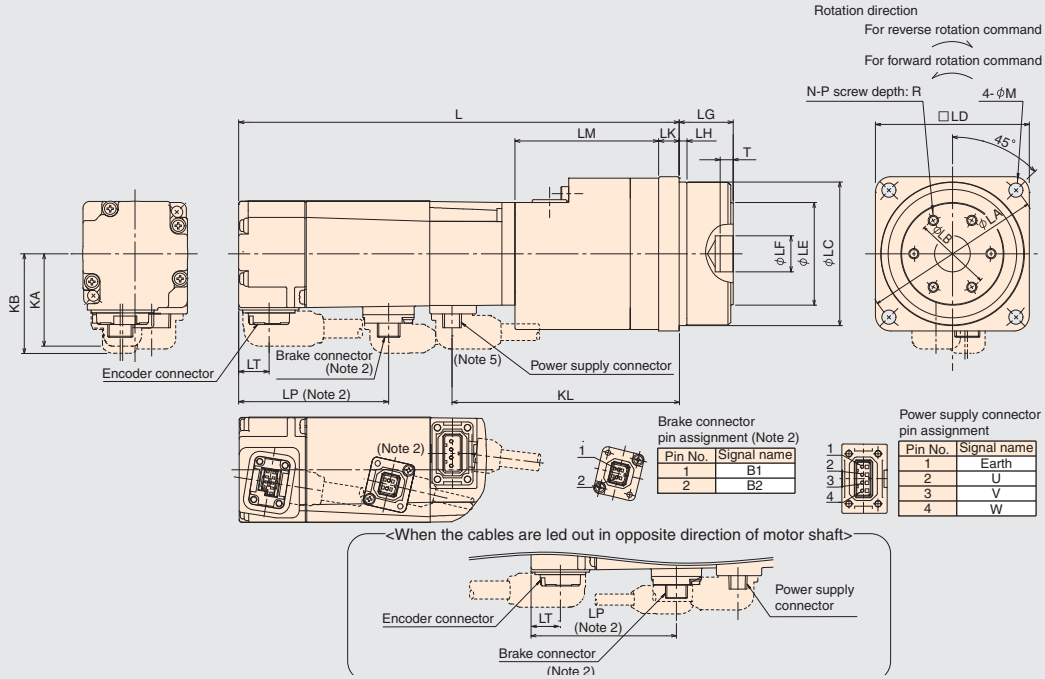

Model	Reduction ratio	Moment of inertia		Variable dimensions																	Mass						
		J ($\times 10^{-4} \text{kg} \cdot \text{m}^2$)	J (oz·in ²)	L	LA	LB	LC	LD	LE	LF	LG	LH	LK	LM	KL	T	N	P	R	M	KA	KB	LT	LP	kg	lb	
HF-KP053(B)G5 (Note 5)	1/5	0.120 (0.122)	0.656 (0.667)	130.4 (171.5)	70	30	56h7	60	40	14H7	21 ^{+0.4} _{-0.5}	3	8	56	88.5	5	6	M4	7	5.5	36	37.1 (38.8)	11.7	-	(58.3)	1.1 (1.4)	2.5 (3.1)
	1/11	0.112 (0.114)	0.612 (0.623)																							1.3 (1.6)	2.9 (3.6)
	1/21	0.103 (0.105)	0.563 (0.574)																							1.4 (1.7)	3.1 (3.8)
	1/33	0.097 (0.099)	0.53 (0.541)																							2.6 (2.9)	5.8 (6.4)
	1/45	0.097 (0.099)	0.53 (0.541)																							2.9 (3.3)	6.4 (7.3)
HF-KP13(B)G5 (Note 5)	1/5	0.156 (0.158)	0.853 (0.864)	146.4 (187.5)	105	45	85h7	90	59	24H7	27 ^{+0.4} _{-0.5}	8	10	56.5	107	5	6	M6	10	9	46	47.1 (47.1)	11.8	-	(57.8)	1.3 (1.6)	2.9 (3.6)
	1/11	0.148 (0.150)	0.809 (0.82)																							2.6 (2.9)	5.8 (6.4)
	1/21	0.139 (0.141)	0.76 (0.771)																							3.4 (4.1)	7.5 (9.1)
	1/33	0.150 (0.152)	0.82 (0.831)																							4.0 (4.6)	8.9 (11)
	1/45	0.149 (0.151)	0.815 (0.826)																							5.1 (5.6)	11 (12.5)
HF-KP23(B)G5 (Note 5)	1/5	0.441 (0.511)	2.41 (2.79)	140.6 (180.1)	70	30	56h7	60	40	14H7	21 ^{+0.4} _{-0.5}	3	8	56	103.3	5	6	M4	7	5.5	46	47.1 (47.1)	11.8	-	(57.8)	1.8 (2.4)	4.0 (5.3)
	1/11	0.443 (0.513)	2.42 (2.80)																							2.3 (2.5)	5.1 (5.6)
	1/21	0.738 (0.808)	4.03 (4.42)																							4.0 (4.6)	11 (12.5)
	1/33	0.692 (0.762)	3.78 (4.17)																							5.1 (5.6)	12.5 (14)
	1/45	0.691 (0.761)	3.78 (4.16)																							6.1 (6.7)	14 (15)
HF-KP43(B)G5	1/5	0.621 (0.701)	3.4 (3.83)	162.5 (202)	70	30	56h7	60	40	14H7	21 ^{+0.4} _{-0.5}	3	8	56	125.2	5	6	M4	7	5.5	46	47.1 (47.1)	11.8	-	(57.8)	2.3 (2.9)	5.1 (6.4)
	1/11	0.996 (1.08)	5.45 (5.90)																							4.0 (4.6)	8.9 (11)
	1/21	0.918 (0.998)	5.02 (5.46)																							6.1 (6.7)	14 (15)
	1/33	0.970 (1.05)	5.3 (5.74)																							7.3 (8.1)	15.5 (17.5)
	1/45	0.964 (1.04)	5.27 (5.69)																							8.1 (9.1)	17.5 (19.5)

- Notes: 1. Dimensions inside () are for the models with electromagnetic brake.
 2. Only for the models with electromagnetic brake. The electromagnetic brake terminals (B1, B2) do not have polarity.
 3. The moments of inertia in the table are the values that are converted into motor shaft for the motor with reducer (and with electromagnetic brake).
 4. For dimensions where there is no tolerance listed, use general tolerance. The actual dimensions may be 1mm to 3mm larger than the dimensions listed since the outer frame of the reducer is made by casting. Design a machine in order to make allowances.
 5. Lead out the power supply cable in opposite direction of the motor shaft for the following servo motors:
 • All gear ratios for HF-KP053(B)G5 and HF-KP13(B)G5
 • Gear ratios of 1/21, 1/33 and 1/45 for HF-KP23(B)G5

HF-KP Series Geared Servo Motor Dimensions

With shaft output type reducer for precision application, flange mounting

(Unit: mm)

● HF-KP□(B)G7

The following is a schematic diagram. The actual shapes or the mounting screws may differ from the following. Refer to the table below and "Servo Motor INSTRUCTION MANUAL (Vol.2)" for details.

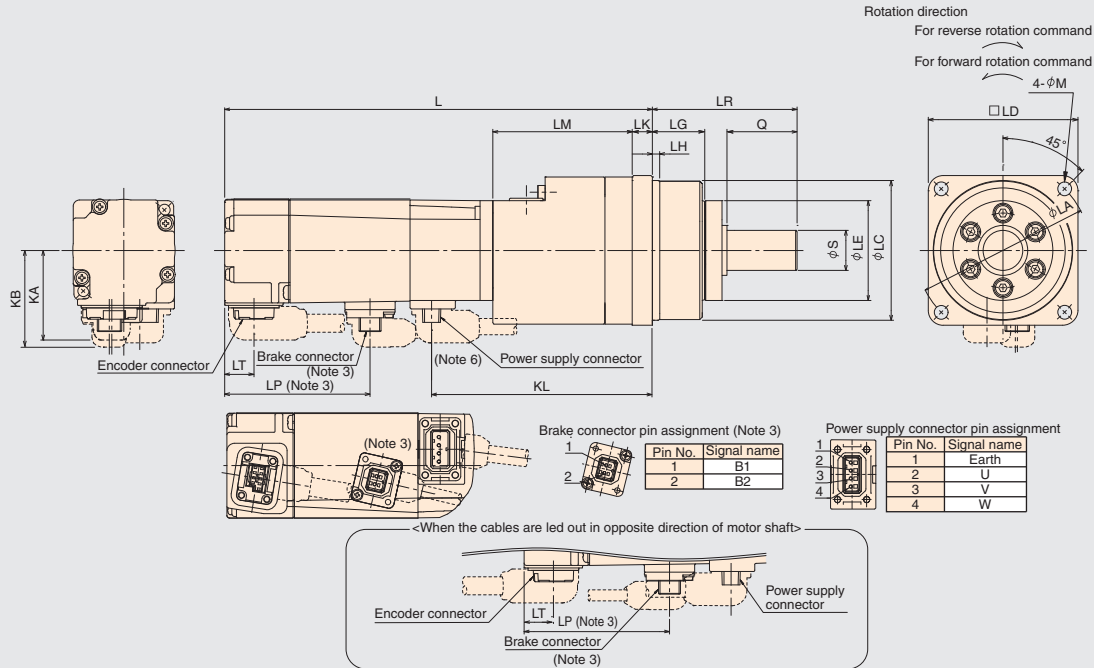

Model	Reduction ratio	Moment of inertia		Variable dimensions																Mass				
		J ($\times 10^{-4} \text{kg}\cdot\text{m}^2$)	J ($\text{oz}\cdot\text{in}^2$)	L	LA	LC	LD	LE	S	LG	LH	Q	LR	LK	LM	KL	M	KA	KB	LT	LP	kg	lb	
HF-KP053(B)G7 (Note 6)	1/5	0.126 (0.128)	0.689 (0.70)	130.4 (171.5)	70	56h7	60	40	16h7	21	3	28	58	8	56	88.5	5.5	36	37.1 (38.8)	11.7	-	(58.3)	1.2 (1.5)	2.7 (3.3)
	1/11	0.113 (0.115)	0.618 (0.629)																				1.3 (1.6)	2.9 (3.6)
	1/21	0.103 (0.105)	0.563 (0.574)																					
	1/33	0.097 (0.099)	0.53 (0.541)																					
	1/45	0.097 (0.099)	0.53 (0.541)																					
HF-KP13(B)G7 (Note 6)	1/5	0.162 (0.164)	0.886 (0.897)	146.4 (187.5)	105	85h7	90	59	25h7	27	8	42	80	10	56.5	107	9						1.4 (1.7)	3.1 (3.8)
	1/11	0.149 (0.151)	0.815 (0.826)																				1.5 (1.8)	3.3 (4.0)
	1/21	0.139 (0.141)	0.76 (0.771)																					
	1/33	0.151 (0.153)	0.826 (0.837)																					
	1/45	0.149 (0.151)	0.815 (0.826)																					
HF-KP23(B)G7 (Note 6)	1/5	0.447 (0.517)	2.44 (2.83)	140.6 (180.1)	70	56h7	60	40	16h7	21	3	28	58	8	56	103.3	5.5						1.9 (2.5)	4.2 (5.6)
	1/11	0.443 (0.513)	2.42 (2.80)																				2.0 (2.6)	4.4 (5.8)
	1/21	0.740 (0.810)	4.05 (4.43)																					
	1/33	0.693 (0.763)	3.79 (4.17)																					
	1/45	0.691 (0.761)	3.78 (4.16)																					
HF-KP43(B)G7	1/5	0.627 (0.707)	3.43 (3.87)	162.5 (202)	70	56h7	60	40	16h7	21	3	28	58	8	56	125.2	5.5	46	47.1 (47.1)	11.8	-	(57.8)	2.4 (3.0)	5.3 (6.7)
	1/11	1.00 (1.08)	5.47 (5.90)																				4.4 (5.0)	9.7 (11)
	1/21	0.920 (1.00)	5.03 (5.47)																					
	1/33	0.976 (1.06)	5.34 (5.80)																					
	1/45	0.967 (1.05)	5.29 (5.74)																					

- Notes: 1. Use a friction coupling to fasten a load.
 2. Dimensions inside () are for the models with electromagnetic brake.
 3. Only for the models with electromagnetic brake. The electromagnetic brake terminals (B1, B2) do not have polarity.
 4. The moments of inertia in the table are the values that are converted into motor shaft for the motor with reducer (and with electromagnetic brake).
 5. For dimensions where there is no tolerance listed, use general tolerance. The actual dimensions may be 1mm to 3mm larger than the dimensions listed since the outer frame of the reducer is made by casting. Design a machine in order to make allowances.
 6. Lead out the power supply cable in opposite direction of the motor shaft for the following servo motors:
 • All gear ratios for HF-KP053(B)G7 and HF-KP13(B)G7
 • Gear ratios of 1/21, 1/33 and 1/45 for HF-KP23(B)G7

To ensure safe use

- To use the products given in this catalog properly, always read the "Installation Guide" and "MR-JN-□A INSTRUCTION MANUAL" before starting to use them.

Cautions concerning use

Transportation and installation of servo motor

- Protect the servo motor or encoder from impact during handling. When installing a pulley or a coupling to the shaft, do not hammer on the shaft-end. Impact may damage the encoder.
When installing the pulley or the coupling to the servo motor which has a key way on the shaft, use the screw hole on the shaft-end.
Use a pulley extractor when removing the pulley.
- Do not apply a load exceeding the tolerable load onto the servo motor shaft. The shaft may break.

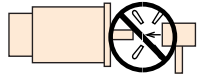

Installation

- Avoid installation in an environment in which oil mist, dust, etc. are in the air. When using in such an environment, enclose the servo amplifier in a sealed cabinet.
Protect the servo motor by furnishing a cover for it or taking similar measures.
- Mount the servo amplifier vertically on a wall.
- Do not block intake and exhaust areas of the servo amplifier. Doing so may cause the servo amplifier to malfunction.
- When installing several servo amplifiers in a row in a sealed cabinet, leave 10mm or more open between each servo amplifier. Servo amplifier can be installed closely. In this case, keep the ambient temperature within 0°C to 45°C (32°F to 113°F), or use them with 75% or less of the effective load rate.
When using one servo amplifier, always leave 40mm or more open in the upward and downward directions.
To ensure the life and reliability, keep space as open as possible toward the top plate so that heat does not build up.
Take special care, especially when installing several amplifiers in a row.
- Be sure to use the servo motor within the specified ambient temperature. Torque may drop due to temperature increase of the servo motor.
- The servo motor without reducer can be mounted in any direction. Note that the mounting direction of some geared motor is predetermined. When mounting vertically (shaft-up), take measures on the machine-side to ensure that oil from the gear box does not get into the servo motor.
- Do not touch the servo motor during or after operation until it has had sufficient time to cool. The motor can be very hot, and severe burns may result from touching the motor.
- The optional regeneration unit becomes hot (the temperature rise of 100°C or more) with frequent use.
Do not install within flammable objects or objects subject to thermal deformation. Take care to ensure that electrical wires do not come into contact with the unit.
- Carefully consider the cable clamping method, and make sure that bending stress and stress of the cable's own weight are not applied on the cable connection section.
- If using in an application where the servo motor moves, select the cable bending radius according to the required bending life and wire type.

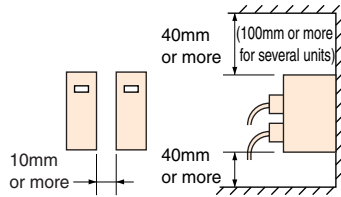

Grounding

- Securely ground to prevent electric shocks and to stabilize the potential in the control circuit.
- To ground the servo motor and servo amplifier at one point, connect the grounding terminals of each unit, and ground from the servo amplifier side.
- Faults such as position mismatch may occur if the grounding is insufficient.

Wiring

- When a commercial power supply is applied to the servo amplifier's output terminals (U, V, W), the servo amplifier will be damaged. Before switching the power on, perform thorough wiring and sequence checks to ensure that there are no wiring errors, etc.
- When a commercial power supply is applied to the servo motor's input terminals (U, V, W), the servo motor will be burned. Connect the servo motor to the servo amplifier's output terminals (U, V, W).
- Match the phase of the servo motor's input terminals (U, V, W) to the servo amplifier's output terminals (U, V, W) when connecting. If they do not match, the servo motor cannot be controlled.
- Validate the stroke end signals (LSP, LSN) in position control or speed control mode.
The servo motor will not start if the signals are invalid.
- Do not use the 24VDC interface and control circuit power supplies for the electromagnetic brake. Provide a power supply designed exclusively for the electromagnetic brake.

Factory settings

- All available combinations of servo motor and servo amplifier are predetermined. Confirm the models of the servo motor and the servo amplifier to be used before installation.
- Select a control mode with parameter PA01. Position control mode is selected as default. Change the parameter setting when using the other control modes.
- When using the optional regeneration unit, change parameter No. PA02. The optional regeneration unit is disabled as default, so the parameter must be changed to increase the regeneration performance.

Operation

- When a magnetic contactor (MC) is installed on the servo amplifier's primary side, do not perform frequent starts and stops with the MC. Doing so may cause the servo amplifier to fail.
- When an error occurs, the servo amplifier's safety features activate, halting output, and the dynamic brake instantly stops the servo motor.
- The dynamic brake is a function for emergency stop. Do not use it for stopping the servo motor in normal operations.
- As a rough guide, the dynamic brake can be used approximately 1000 times when a machine that has load to motor inertia moment ratio equals to or lower than the recommended ratio stops from the rated speed every 10 minutes.
- When using the servo motor with an electromagnetic brake, do not apply the electromagnetic brake when the servo is on. Doing so may cause the servo amplifier overload or shorten the electromagnetic brake life. Apply the electromagnetic brake when the servo is off.

Cautions concerning model selection

- Select a servo motor with a rated torque above the continuous effective load torque.
- When unbalanced torque is generated, such as in a vertical lift machine, it is recommended that the unbalanced torque of the machine be kept under 70% of the motor's rated torque.
- Design the operation pattern in the command section so that positioning can be completed, taking the stop setting time (t_s) into account.

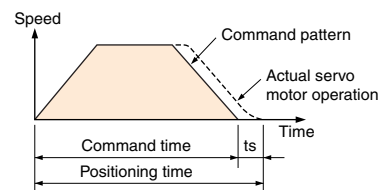

- The load inertia moment should be below the recommended load inertia moment ratio of the servo motor being used.
If it is too large, desired performance may not be attainable.

Warranty

1. Warranty period and coverage

We will repair any failure or defect hereinafter referred to as "failure" in our FA equipment hereinafter referred to as the "Product" arisen during warranty period at no charge due to causes for which we are responsible through the distributor from which you purchased the Product or our service provider. However, we will charge the actual cost of dispatching our engineer for an on-site repair work on request by customer in Japan or overseas countries. We are not responsible for any on-site readjustment and/or trial run that may be required after a defective unit is repaired or replaced.

[Term]

The term of warranty for Product is twelve (12) months after your purchase or delivery of the Product to a place designated by you or eighteen (18) months from the date of manufacture whichever comes first ("Warranty Period"). Warranty period for repaired Product cannot exceed beyond the original warranty period before any repair work.

[Limitations]

- (1) You are requested to conduct an initial failure diagnosis by yourself, as a general rule. It can also be carried out by us or our service company upon your request and the actual cost will be charged.
However, it will not be charged if we are responsible for the cause of the failure.
- (2) This limited warranty applies only when the condition, method, environment, etc. of use are in compliance with the terms and conditions and instructions that are set forth in the instruction manual and user manual for the Product and the caution label affixed to the Product.
- (3) Even during the term of warranty, the repair cost will be charged on you in the following cases;
 - (i) a failure caused by your improper storing or handling, carelessness or negligence, etc., and a failure caused by your hardware or software problem
 - (ii) a failure caused by any alteration, etc. to the Product made on your side without our approval
 - (iii) a failure which may be regarded as avoidable, if your equipment in which the Product is incorporated is equipped with a safety device required by applicable laws and has any function or structure considered to be indispensable according to a common sense in the industry
 - (iv) a failure which may be regarded as avoidable if consumable parts designated in the instruction manual, etc. are duly maintained and replaced
 - (v) any replacement of consumable parts (battery, fan, smoothing capacitor, etc.)
 - (vi) a failure caused by external factors such as inevitable accidents, including without limitation fire and abnormal fluctuation of voltage, and acts of God, including without limitation earthquake, lightning and natural disasters
 - (vii) a failure generated by an unforeseeable cause with a scientific technology that was not available at the time of the shipment of the Product from our company
 - (viii) any other failures which we are not responsible for or which you acknowledge we are not responsible for

2. Term of warranty after the stop of production

- (1) We may accept the repair at charge for another seven (7) years after the production of the product is discontinued. The announcement of the stop of production for each model can be seen in our Sales and Service, etc.
- (2) Please note that the Product (including its spare parts) cannot be ordered after its stop of production.

3. Service in overseas countries

Our regional FA Center in overseas countries will accept the repair work of the Product. However, the terms and conditions of the repair work may differ depending on each FA Center. Please ask your local FA Center for details.

4. Exclusion of responsibility for compensation against loss of opportunity, secondary loss, etc.

Whether under or after the term of warranty, we assume no responsibility for any damages arisen from causes for which we are not responsible, any losses of opportunity and/or profit incurred by you due to a failure of the Product, any damages, secondary damages or compensation for accidents arisen under a specific circumstance that are foreseen or unforeseen by our company, any damages to products other than the Product, and also compensation for any replacement work, readjustment, start-up test run of local machines and the Product and any other operations conducted by you.

5. Change of Product specifications

Specifications listed in our catalogs, manuals or technical documents may be changed without notice.

6. Application and use of the Product

- (1) For the use of our General-Purpose AC Servo, its applications should be those that may not result in a serious damage even if any failure or malfunction occurs in General-Purpose AC Servo, and a backup or fail-safe function should operate on an external system to General-Purpose AC Servo when any failure or malfunction occurs.
- (2) Our General-Purpose AC Servo is designed and manufactured as a general purpose product for use at general industries. Therefore, applications substantially influential on the public interest for such as atomic power plants and other power plants of electric power companies, and also which require a special quality assurance system, including applications for railway companies and government or public offices are not recommended, and we assume no responsibility for any failure caused by these applications when used.
In addition, applications which may be substantially influential to human lives or properties for such as airlines, medical treatments, railway service, incineration and fuel systems, man-operated material handling equipment, entertainment machines, safety machines, etc. are not recommended, and we assume no responsibility for any failure caused by these applications when used.
We will review the acceptability of the abovementioned applications, if you agree not to require a specific quality for a specific application. Please contact us for consultation.

Global FA Centers



**Shanghai
FA Center**

Mitsubishi Electric Automation (CHINA) Ltd.
4/F., Zhi Fu Plaza No.80 Xin Chang Road, Shanghai,
200003, China
Tel: 86-21-2322-3030 Fax: 86-21-2322-3000

**Beijing
FA Center**

Mitsubishi Electric Automation (CHINA) Ltd. Beijing Office
Unit904-905, 9F, Office Tower, Henderson Centre,
18 Jianguomennei Avenue, Dongcheng District, Beijing, China
Tel: 86-10-6518-8830 Fax: 86-10-6518-3907

**Tianjin
FA Center**

Mitsubishi Electric Automation (CHINA) Ltd. Tianjin Office
B-2-801-802, Youyi Building, 50 Youyi Road, Hexi District,
Tianjin, China
Tel: 86-22-2813-1015 Fax: 86-22-2813-1017

**Guangzhou
FA Center**

Mitsubishi Electric Automation (CHINA) Ltd. Guangzhou Office
Rm.1609, North Tower, The Hub Center, No.1068,
Xin Gang East Road, Haizhu District, Guangzhou, China
Tel: 86-20-8923-6730 Fax: 86-20-8923-6715

**Hong
Kong
FA Center**

Mitsubishi Electric Automation (HONGKONG) Ltd.
10th Floor, Manulife Tower, 169 Electric Road, North Point,
Hong Kong
Tel: 852-2887-8870 Fax: 852-2887-7984

**Taiwan
FA Center**

Setsuyo Enterprise Co., Ltd.
6F No.105 Wu kung 3rd RD, Wu-Ku Hsiang, Taipei Hsien, 248,
Taiwan, R.O.C.
Tel: 886-2-2299-2499 Fax: 886-2-2299-2509

**Korean
FA Center**

Mitsubishi Electric Automation Korea Co., Ltd. (Service)
B1F, 2F, 1480-6, Gayang-Dong, Gangseo-Gu, Seoul, 157-200,
Korea
Tel: 82-2-3660-9630 Fax: 82-2-3663-0475

**Thailand
FA Center**

Mitsubishi Electric Automation (Thailand) Co., Ltd.
Bang-Chan Industrial Estate No.111, Soi Serithai 54,
T.Kannayao, A.Kannayao, Bangkok 10230, Thailand
Tel: 66-2906-3238 Fax: 66-2906-3239

**ASEAN
FA Center**

Mitsubishi Electric Asia Pte. Ltd. ASEAN Factory Automation Centre
307 Alexandra Road #05-01/02, Mitsubishi Electric Building,
Singapore
Tel: 65-6470-2460 Fax: 65-6476-7439

**India
FA Center**

Mitsubishi Electric India Pvt. Ltd. India Factory Automation Centre
2nd Floor, DLF Building No.9B, DLF Cyber City Phase III,
Gurgaon 122002, Haryana, India
Tel: 91-124-4630300 Fax: 91-124-4630399

**North
American
FA Center**

Mitsubishi Electric Automation, Inc.
500 Corporate Woods Parkway, Vernon Hills, IL 60061, U.S.A
Tel: 1-847-478-2100 Fax: 1-847-478-2253

**Brazil
FA Center**

MELCO-TEC Representacao Comercial e Assessoria Tecnica
Ltda.
Av. Paulista, 1439, Cerqueira Cesar - Sao Paulo Brazil - CEP
01311-200
Tel: 55-11-3146-2200 Fax: 55-11-3146-2217

**European
FA Center**

Mitsubishi Electric Europe B.V. Polish Branch
ul. Krakowska 50, 32-083 Balice, Poland
Tel: 48-12-630-4700 Fax: 48-12-630-4701

**German
FA Center**

Mitsubishi Electric Europe B.V. - German Branch
Gothaer Strasse 8, D-40880 Ratingen, Germany
Tel: 49-2102-486-0 Fax: 49-2102-486-1120

**Czech
Republic
FA Center**

Mitsubishi Electric Europe B.V. -o.s. Czech office
Avenir Business Park, Radicka 714/113a, 158 00 Praha5,
Czech Republic
Tel: 420-251-551-470 Fax: 420-251-551-471

**UK
FA Center**

Mitsubishi Electric Europe B.V. UK Branch
Travellers Lane, Hatfield, Hertfordshire, AL10 8XB, UK.
Tel: 44-1707-27-6100 Fax: 44-1707-27-8695

**Russian
FA Center**

Mitsubishi Electric Europe B.V. Russian Branch
St.Petersburg office
Sverdlovskaya emb., bld "Sch", BC "Benuea", office 720; 195027,
St.Petersburg, Russia
Tel: 7-812-633-3497 Fax: 7-812-633-3499

Mitsubishi Electric Corporation Nagoya Works is a factory certified for ISO14001 (standards for environmental management systems) and ISO9001 (standards for quality assurance management systems)

**Empowering
Industries**





Safety Warning

To ensure proper use of the products listed in this catalog,
please be sure to read the instruction manual prior to use.

 **MITSUBISHI ELECTRIC CORPORATION**
HEAD OFFICE : TOKYO BLDG., 2-7-3, MARUNOUCHI, CHIYODA-KU, TOKYO 100-8310, JAPAN