

SCREW COVER, TYPE 12

INDUSTRY STANDARDS

UL 50, 50E Listed; Type 12, 13; File No. E27525
 cUL Listed per CSA C22.2 No. 94; Type 12, 13; File No. E27525
 UL 508A Listed; Type 12, 13; File No. E61997
 cUL Listed per CSA C22.2 No. 94; Type 12, 13; File No. E61997

NEMA/EEMAC: Type 12 and 13
 CSA, File No. 42184: Type 12
 IEC 60529, IP65

APPLICATION

Ideal for a broad range of applications, this enclosure's screw cover is secured in each corner for a positive seal but easily removed for modifications.

SPECIFICATIONS

- 16 or 14 gauge steel
- Seams continuously welded and ground smooth
- Bonding provision on cover
- Oil-resistant gasket
- Weldnuts provided for mounting optional panels and terminal block kits in size 6.00 x 4.00 in. (152 x 102 mm) and larger
- External welded-on mounting brackets for easy installation

FINISH

ANSI 61 gray polyester powder paint inside and out

ACCESSORIES

See also *Accessories*.

Panels for Junction Boxes
 Junction Box and Wall-Mount Enclosure Swing Out Panel Kit
 Terminal Block Kit Assembly for Junction Boxes
 Steel and Stainless Steel Window Kits

MODIFICATION AND CUSTOMIZATION

Hoffman excels at modifying and customizing products to your specifications. Contact your local Hoffman sales office or distributor for complete information.

BULLETIN: A51SC

Standard Product

Catalog Number	AxBxC in./mm	Gauge	UL Listed	Panel	Conductive Panel	Panel Size D x E in./mm	Mounting G x H in./mm	Overall L x W in./mm	F in./mm	J in./mm	K in./mm	T in./mm	V in./mm	Y in./mm
A404SC	4.00 x 4.00 x 3.00 102 x 102 x 76	16	508A	No Panel	No Panel	No Panel No Panel	4.75 x 2.00 121 x 51	5.50 x 4.23 140 x 107	— —	2.50 64	0.66 17	3.00 76	— —	— —
A604SC	6.00 x 4.00 x 3.00 152 x 102 x 76	16	508A	A6P4	A6P4G	4.88 x 2.88 124 x 73	6.75 x 2.00 171 x 51	7.50 x 4.23 191 x 107	2.53 64	2.50 64	0.66 17	3.00 76	0.31 8	0.56 14
A806SC	8.00 x 6.00 x 3.50 203 x 152 x 89	14	50, 50E	A8P6	A8P6G	6.75 x 4.88 171 x 124	8.75 x 4.00 222 x 102	9.50 x 6.28 241 x 160	3.03 77	3.01 76	0.67 17	5.00 127	0.25 6	0.62 16
A4044SC	4.00 x 4.00 x 4.00 102 x 102 x 102	16	508A	No Panel	No Panel	No Panel No Panel	4.75 x 2.00 121 x 51	5.50 x 4.23 140 x 107	— —	3.50 89	0.66 17	3.00 76	— —	— —
A6044SC	6.00 x 4.00 x 4.00 152 x 102 x 102	16	508A	A6P4	A6P4G	4.88 x 2.88 124 x 73	6.75 x 2.00 171 x 51	7.50 x 4.23 191 x 107	3.53 90	3.50 89	0.66 17	3.00 76	0.31 8	0.56 14
A606SC	6.00 x 6.00 x 4.00 152 x 152 x 102	16	50, 50E	A6P6	A6P6G	4.88 x 4.88 124 x 124	6.75 x 4.00 171 x 102	7.50 x 6.28 191 x 160	3.53 90	3.50 89	0.66 17	5.00 127	0.31 8	0.56 14
A808SC	8.00 x 8.00 x 4.00 203 x 203 x 102	14	50, 50E	A8P8	A8P8G	6.75 x 6.88 171 x 175	8.75 x 6.00 222 x 152	9.50 x 8.28 241 x 210	3.53 90	3.51 89	0.67 17	7.00 178	0.25 6	0.62 16
A1008SC	10.00 x 8.00 x 4.00 254 x 203 x 102	14	50, 50E	A10P8	A10P8G	8.75 x 6.88 222 x 175	10.75 x 6.00 273 x 152	11.50 x 8.28 292 x 210	3.53 90	3.51 89	0.67 17	7.00 178	0.25 6	0.62 16
A1010SC	10.00 x 10.00 x 4.00 254 x 254 x 102	14	50, 50E	A10P10	A10P10G	8.75 x 8.88 222 x 226	10.75 x 8.00 273 x 203	11.50 x 10.28 292 x 261	3.53 90	3.51 89	0.67 17	9.00 229	0.25 6	0.62 16
A1210SC	12.00 x 10.00 x 5.00 305 x 254 x 127	14	50, 50E	A12P10	A12P10G	10.75 x 8.88 273 x 226	12.75 x 8.00 324 x 203	13.50 x 10.28 343 x 261	4.53 115	4.51 115	0.67 17	9.00 229	0.25 6	0.62 16
A8066SC	8.00 x 6.00 x 6.00 203 x 152 x 152	14	50, 50E	A8P6	A8P6G	6.75 x 4.88 171 x 124	8.75 x 4.00 222 x 102	9.50 x 6.28 241 x 160	5.53 140	5.51 140	0.67 17	5.00 127	0.25 6	0.62 16
A10086SC	10.00 x 8.00 x 6.00 254 x 203 x 152	14	50, 50E	A10P8	A10P8G	8.75 x 6.88 222 x 175	10.75 x 6.00 273 x 152	11.50 x 8.28 292 x 210	5.53 140	5.51 140	0.67 17	7.00 178	0.25 6	0.62 16
A10106SC	10.00 x 10.00 x 6.00 254 x 254 x 152	14	50, 50E	A10P10	A10P10G	8.75 x 8.88 222 x 226	10.75 x 8.00 273 x 203	11.50 x 10.28 292 x 261	5.53 140	5.51 140	0.67 17	9.00 229	0.25 6	0.62 16
A1212SC	12.00 x 12.00 x 6.00 305 x 305 x 152	14	50, 50E	A12P12	A12P12G	10.75 x 10.88 273 x 276	12.75 x 10.00 324 x 254	13.50 x 12.28 343 x 312	5.53 140	5.51 140	0.67 17	11.00 279	0.25 6	0.62 16
A1412SC	14.00 x 12.00 x 6.00 356 x 305 x 152	14	50, 50E	A14P12	A14P12G	12.75 x 10.88 324 x 276	14.75 x 10.00 375 x 254	15.50 x 12.28 394 x 312	5.53 140	5.51 140	0.67 17	11.00 279	0.25 6	0.62 16
A1614SC	16.00 x 14.00 x 6.00 406 x 356 x 152	14	UL 50	A16P14	A16P14G	14.75 x 12.88 375 x 327	16.75 x 12.00 425 x 305	17.50 x 14.28 445 x 363	5.53 140	5.51 140	0.67 17	13.00 330	0.25 6	0.62 16
A14128SC	14.00 x 12.00 x 8.00 356 x 305 x 203	14	50, 50E	A14P12	A14P12G	12.75 x 10.88 324 x 276	14.75 x 10.00 375 x 254	15.50 x 12.28 394 x 312	7.53 191	7.51 191	0.67 17	11.00 279	0.25 6	0.62 16
A121010SC	12.00 x 10.00 x 10.00 305 x 254 x 254	14	50, 50E	A12P10	A12P10G	10.75 x 8.88 273 x 226	12.75 x 8.00 324 x 203	13.50 x 10.28 343 x 261	9.53 242	9.51 241	0.67 17	9.00 229	0.25 6	0.62 16
A161410SC	16.00 x 14.00 x 10.00 406 x 356 x 254	14	50, 50E	A16P14	A16P14G	14.75 x 12.88 375 x 327	16.75 x 12.00 425 x 305	17.50 x 14.28 445 x 363	9.53 242	9.51 241	0.67 17	13.00 330	0.25 6	0.62 16

Purchase panels separately. Optional stainless steel, conductive, composite and aluminum panels are available for most sizes.

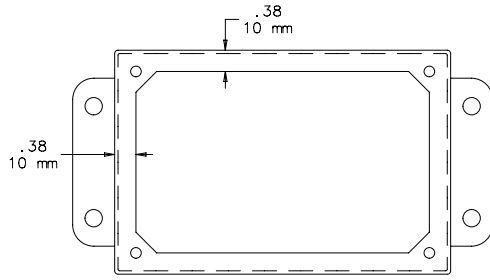

TOP VIEW WITH COVER REMOVED

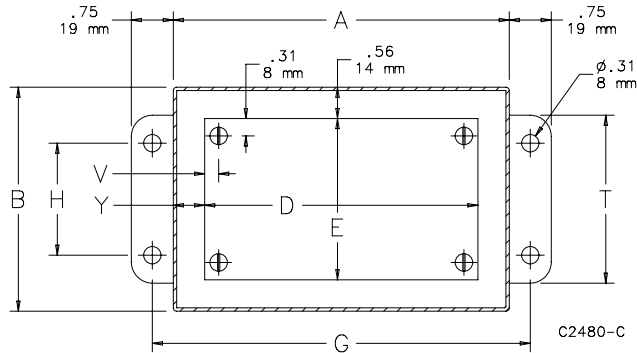
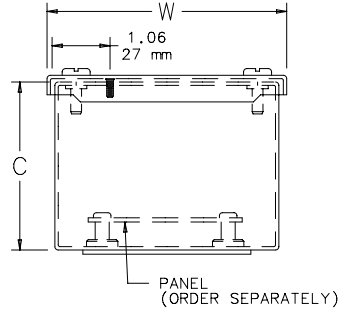
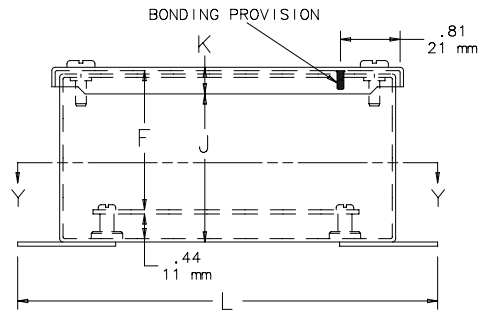

SECTION Y-Y